

Nationale Hinterlegungen

In der folgenden Liste werden die beim Eidgenössischen Institut für Geistiges Eigentum hinterlegten Designs publiziert. Dabei sind der Reihe nach angegeben:

- internationale Klassenangaben
- Hinterlegungsnummer
- Hinterlegungsdatum
- Allenfalls Aufschub der Veröffentlichung
- Anzahl der hinterlegten Designs
- Bezeichnung
- Name und Wohnsitz des Hinterlegers oder der Hinterlegerin
- gegebenenfalls Name und Wohnsitz des Designers oder der Designerin
- Name und Geschäftssitz des allfälligen Vertreters oder der Vertreterin
- gegebenenfalls Prioritätsangaben
- gegebenenfalls Beschreibungstext
- Ordnungsnummer
- Reproduktion des Designs

Internationale Hinterlegungen

Die bei der Weltorganisation für geistiges Eigentum in Genf hinterlegten Muster und Modelle mit Benennung Schweiz geniessen den gleichen Schutz wie national hinterlegte Designs. Sie werden jeweils im Blatt «Bulletin des dessins et modèles internationaux» veröffentlicht. Dieses Publikationsorgan ist deshalb für eine vollständige Recherche unbedingt beizuziehen.

Topographien

Angaben über die vom Eidgenössischen Institut für Geistiges Eigentum eingetragenen Topographien von Halbleitererzeugnissen werden in folgender Anordnung aufgeführt:

- Eintragsnummer
- Anmeldedatum
- Bezeichnung
- Name und Wohnsitz des Anmelders oder der Anmelderin
- gegebenenfalls Name und Wohnsitz des Herstellers oder der Herstellerin
- Name und Geschäftssitz des oder der allfälligen Bevollmächtigten
- Datum und Ort einer allfälligen ersten geschäftlichen Verbreitung der Topographie

Dépôts nationaux

Les designs déposés à l'Institut Fédéral de la Propriété Intellectuelle sont publiés dans la liste qui suit. Les indications y relatives sont mentionnées dans cet ordre:

- indications des classes internationales
- numéro de dépôt
- date de dépôt
- le cas échéant, ajournement de la publication
- nombre des designs déposés
- désignation
- nom et domicile du/de la déposant/e
- le cas échéant, nom et domicile du/de la designer
- nom et domicile de l'éventuel/le mandataire
- le cas échéant, indication de priorité
- le cas échéant, description du design
- numéro attribué à chaque design
- reproduction du design

Dépôts internationaux

Les dessins et modèles déposés à l'Organisation Mondiale de la Propriété Intellectuelle à Genève qui désignent la Suisse jouissent de la même protection que les dépôts nationaux. Ils sont chaque fois publiés dans la feuille «Bulletin des dessins et modèles internationaux». Pour une recherche complète, il est indispensable de consulter ledit organe de publication.

Topographies

Les indications concernant les topographies des produits semi-conducteurs, enregistrées par l'Institut Fédéral de la Propriété Intellectuelle, sont énumérées dans l'ordre suivant:

- numéro d'enregistrement
- date de dépôt
- désignation
- nom et domicile du/de la déposant/e
- le cas échéant, nom et domicile du/de la producteur/trice
- nom et domicile de l'éventuel/le mandataire
- date et lieu d'une éventuelle première mise en circulation de la topographie

Depositi nazionali

Nella lista seguente vengono pubblicati i design depositati presso l'Istituto Federale della Proprietà Intellettuale. Sono menzionati nel seguente ordine:

- indicazioni delle classi internazionali
- numero di deposito
- data del deposito
- se del caso, indicazione che la pubblicazione è stata differita
- numero dei design depositati
- designazione
- nome e domicilio del depositante
- se del caso, nome e domicilio del designer
- nome e sede di un eventuale mandataro
- se del caso, indicazioni di priorità
- se del caso, descrizione del design
- numero d'ordine
- riproduzione del design

Depositi internazionali

I disegni e modelli depositati presso l'Organizzazione Mondiale della Proprietà Intellettuale a Ginevra con denominazione Svizzera godono della medesima protezione del deposito nazionale. Essi vengono pubblicati ogni volta nel foglio «Bulletin des dessins et modèles internationaux». Quest'organo di pubblicazione è da consultare se si vuole effettuare una ricerca completa.

Topografie

Le indicazioni concernenti le topografie di prodotti a semiconduttori depositati presso l'Istituto Federale della Proprietà Intellettuale sono menzionate nell'ordine seguente:

- numero di registrazione
- data del deposito
- designazione
- nome e domicilio del/la richiedente
- se del caso, nome e domicilio del/la produttore/trice
- nome e sede di un eventuale mandataro
- data e luogo di un'eventuale prima messa in circolazione della topografia

**Hinterlegungen
Dépôts
Deposit**

Cl. 25-01 **129 086** 22.10.2002
 1 Design – Konstruktionsprofil
 Hinterleger: Ing. Büro M. Kyburz AG, Solarweg,
 8427 Freienstein
 Designer: Martin Kyburz, Freienstein
 Vertreter: Patentanwälte Feldmann & Partner AG,
 8152 Glattbrugg

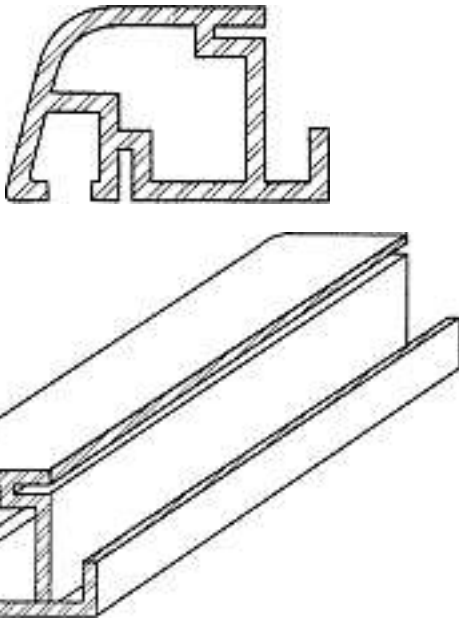

kym 2/MM/CH
 Ende aufgeschobene Publikation

Cl. 10-02 10-07 **129 104** 07.09.2002
 4 Design – Armbanduhr, Uhrenbandanstoss
 Hinterleger: SWC Swiss Watch Company Ltd., c/o Deborah
 Hess, Alfred Aebi-Strasse 84, 2503 Biel/Bienne
 Designer: Stefan Messmer, Basel



SE1

SW1



SE2



SW2
 Ende aufgeschobene Publikation

Cl. 10-02 10-07 **129 105** 03.10.2002
 25 design – montres et parties de montres
 Déposant: Philippe Bonfanti, Foyer APAT, ch. 28, 7, rue du
 Lycée, Pontarlier, FR
 Mandataire: Pierre Serge Heger, 1630 Bulle



A1



A2

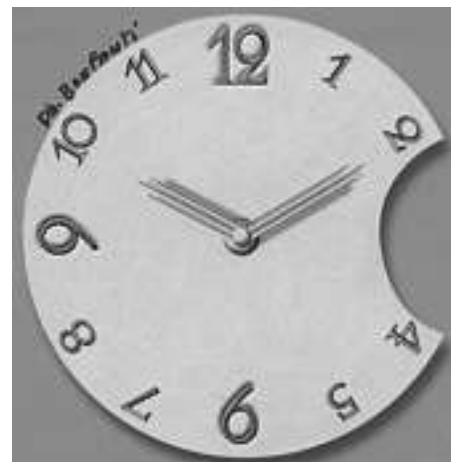

A3



A4



A10

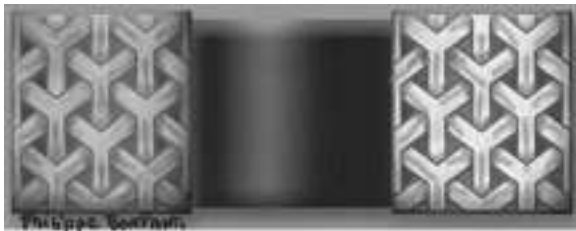

A5



A11

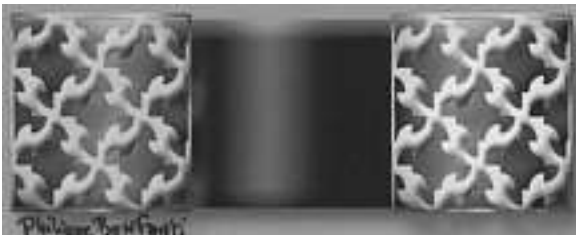

A6

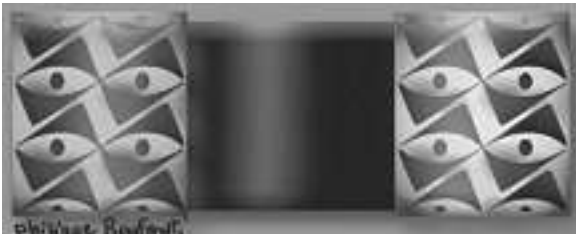

A7

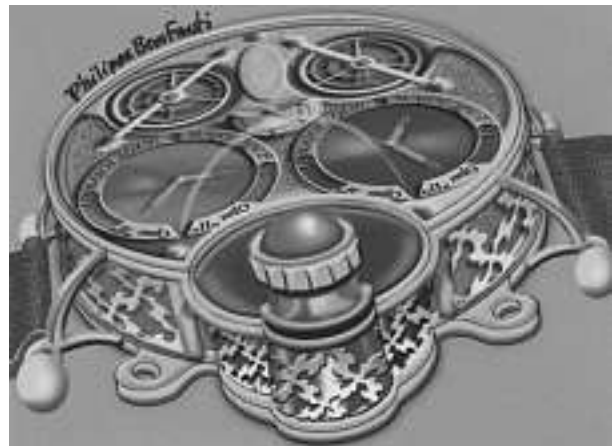

A12

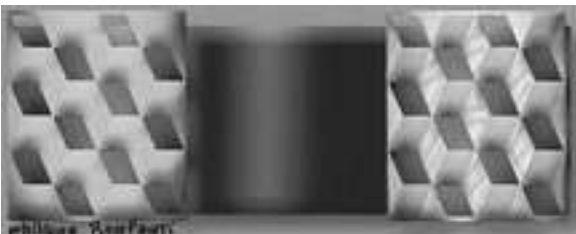

A8

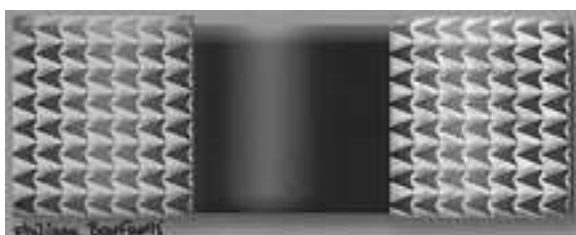

A9

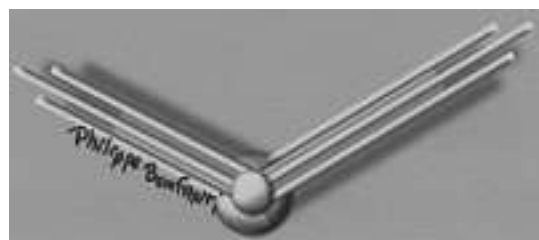

A13



A14



A15

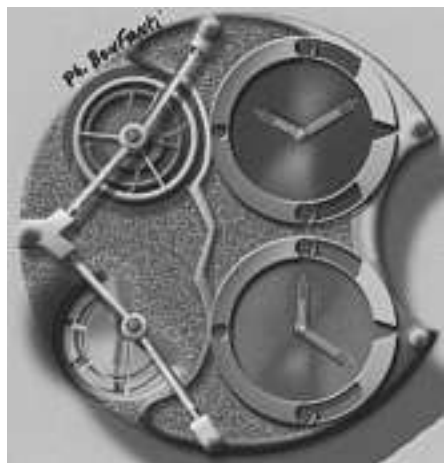

A16



A17-A18



A19-A20



A21



A22





A23



A24



A25



B1-B3



C1

Fin de la periode ajournement de la publication

Cl. 09-03 **129 141** 05.11.2002
 3 Design – Lebensmittelbehälter
 Hinterleger: Hilcona AG, Bendererstrasse 21, 9494 Schaan, LI
 Designer: Thomas Friedli, Schaan; Roger Engler, Schaan
 Vertreter: Peter Schmidheiny, 9475 Sevelen





Trio mio 1

Trio mio 2





Trio mio 3
Ende aufgeschobene Publikation

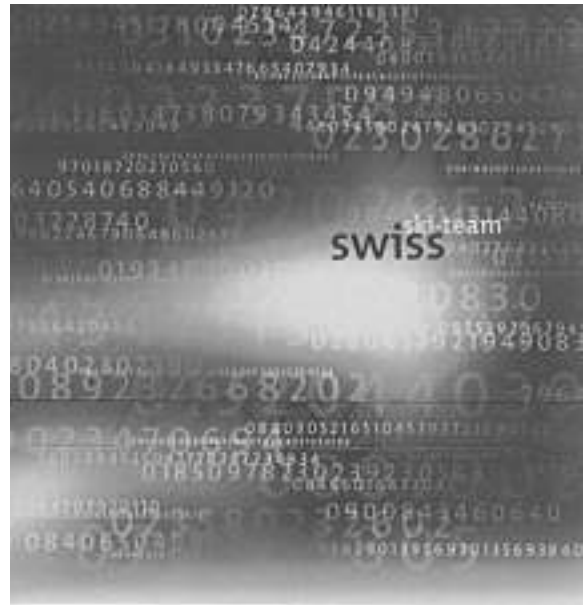

382-CH-MOD1/251165
Ende aufgeschobene Publikation

Cl. 12-08 **129 238** 18.10.2002

1 Design – Fahrzeug

Hinterleger: Ing. Büro M. Kyburz AG, Solarweg,
8427 Freienstein

Designer: Daniel Johner, Freienstein

Vertreter: Patentanwälte Feldmann & Partner AG,
8152 Glattbrugg



Cl. 05-05 **129 216** 24.12.2002

1 Design – Stoffbemusterung

Hinterleger: Swisscom AG, Alte Tiefenaustrasse 6, 3050 Bern

Designer: Fredy Trümpi, Binz

Vertreter: Fuhrer Marbach & Partner, 3007 Bern



kym 1/MM/CH
Ende aufgeschobene Publikation

Cl. 09-03 **129 985** 06.10.2003
 10 design – paquets de cigarettes
 Déposant: Philip Morris Products S.A., Quai Jeanrenaud 3,
 2000 Neuchâtel
 Designer: Jean-Pierre René Grandjean, Jouxens-Mézery;
 Alessandro Velloni, Renens; Javier Peña, Lausanne
 Mandataire: Bovard AG, 3000 Bern 25
 Priorité: EM, 07.04.2003; EM, 07.04.2003



300357 (A) 1



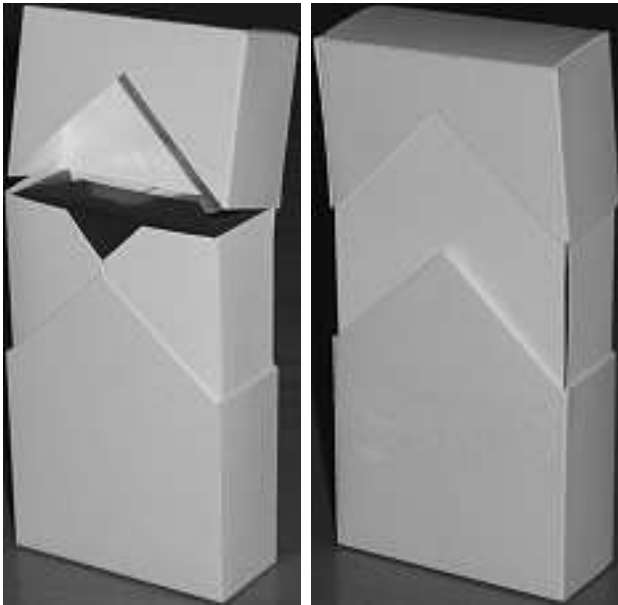

300357 (A) 2



300357 (A) 3

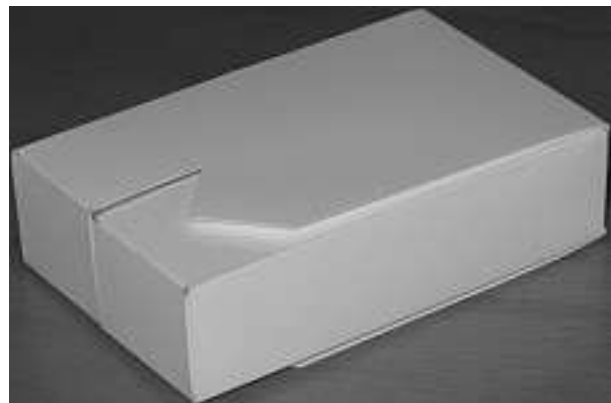



300357 (A) 4



300357 (B) 1

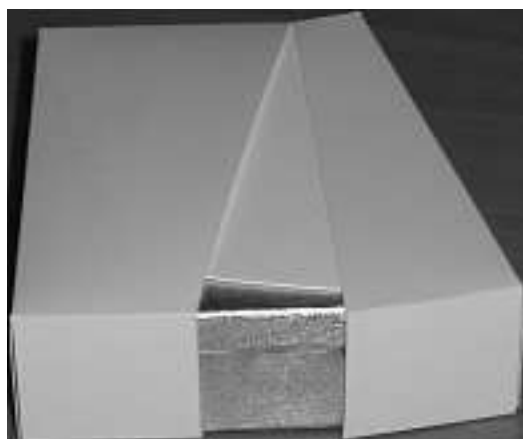
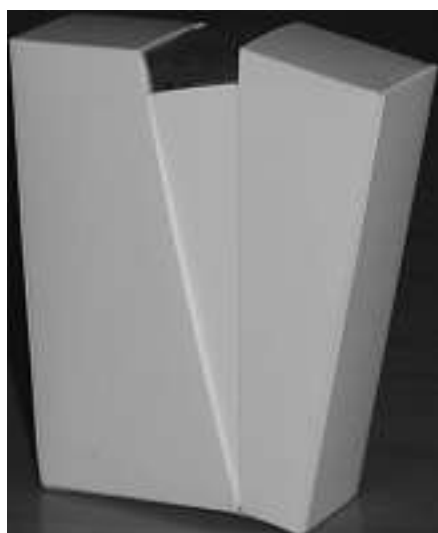

300357 (B) 2



300357 (B) 3



300357 (B) 4





300357 (B) 5



300357 (B) 6
Fin de la période ajournement de la publication

Cl. 10-07 **131 379** 20.01.2005

2 design – boîtier de montre, cadran de montre
Déposant: de Grisogono S.A., 176bis, Route de Saint-Julien,
1228 Plan-les-Ouates

Designer: Fawaz Gruosi, Prangins

Mandataire: Griffes Consulting S.A., 1206 Genève

Description de design: Le cadran de montre est composé de plusieurs lames disposées de façon à ce qu'elles soient mobiles dans le plan de visualisation. Ainsi à l'aide d'un mécanisme secondaire, elles se déplacent, tel un diaphragme et donc ces lamelles qui forment le cadran, donnent un effet d'ouverture ou de fermeture.

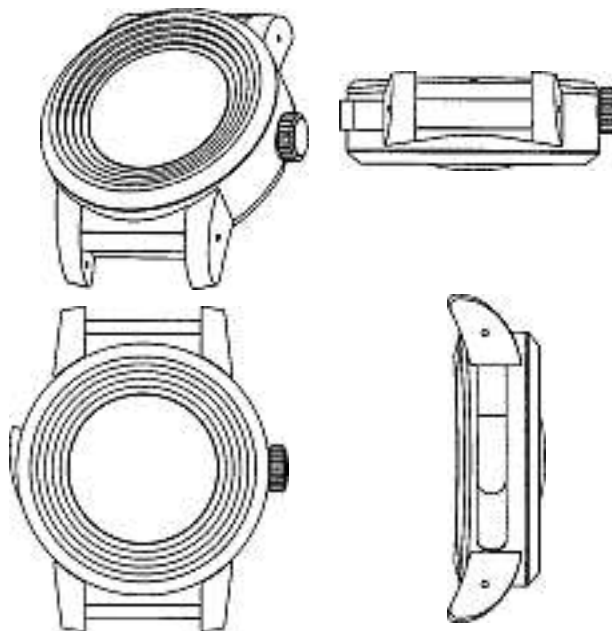

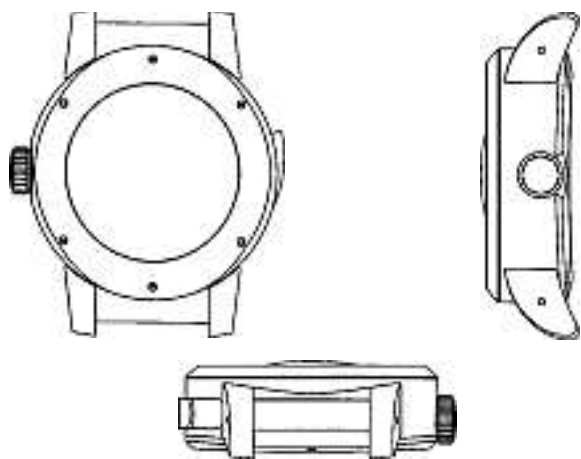

1

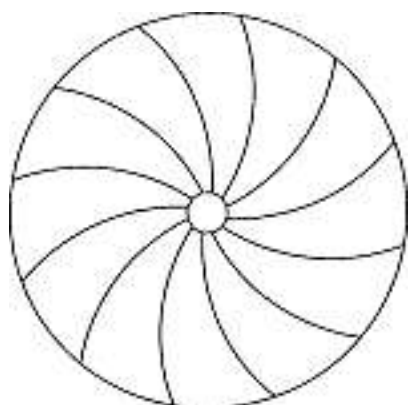

2

Fin de la periode ajournement de la publication

Cl. 01-01 131 680 03.05.2005

1 design – glaces alimentaires
 Déposant: Société des Produits Nestlé SA, 1800 Vevey
 Designer: Laurent Del Bianco, Paris
 Mandataire: Nestec S.A., 1800 Vevey



FL 57404

Cl. 02-03 131 681 07.04.2005

2 design – bonnets
 Déposant: Eisbär Sportmoden GmbH, Hauptstrasse 15, 4101
 Feldkirchen, AT
 Designer: Susanna Wöss, Feldkirchen
 Mandataire: Cabinet Roland Nithardt, Conseils en Propriété
 Industrielle SA, 1400 Yverdon-les-Bains
 Priorité: EM, 15.10.2004





10798-1



10798-2



Cl. 03-01 **131 682** 05.04.2005
 1 Design – Schlüsselanhänger
 Hinterleger: David Scholz, Bleicherweg 52, 8002 Zürich



Kravattenanhänger

Cl. 04-02 **131 683** 11.04.2005
 1 Design – Zahnbürstengriff
 Hinterleger: Colgate-Palmolive Company, 300 Park Avenue,
 New York (NY), US
 Designer: Eduardo Jimenez, Manalapan; Al Sprosta, Union
 Vertreter: E. Blum & Co., 8044 Zürich
 Priorität: US, 12.10.2004

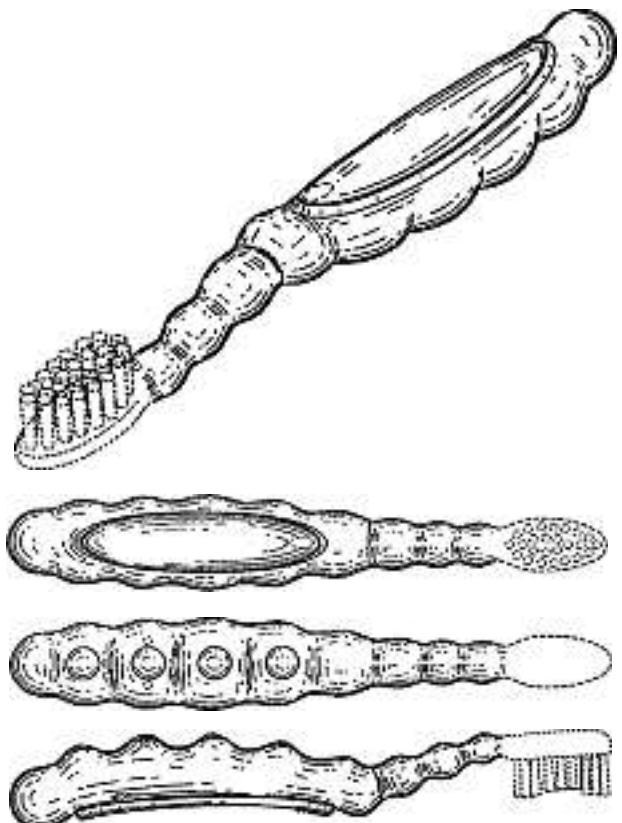

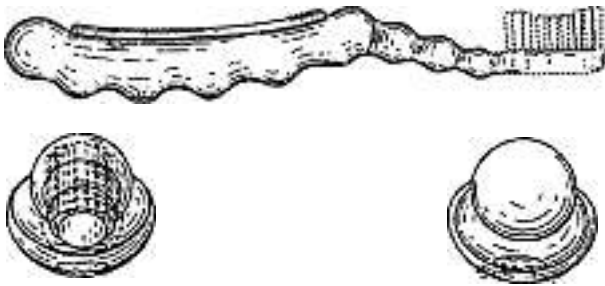

A-2005/1018

Cl. 05-05 131 684 01.04.2005
 8 design – tessuto intrecciato con sovrimpressioni
 Depositante: Paolo Cavazza, Via Tesserete 44A, 6900 Lugano
 Mandatario: Fiammenghi-Fiammenghi, 6900 Lugano

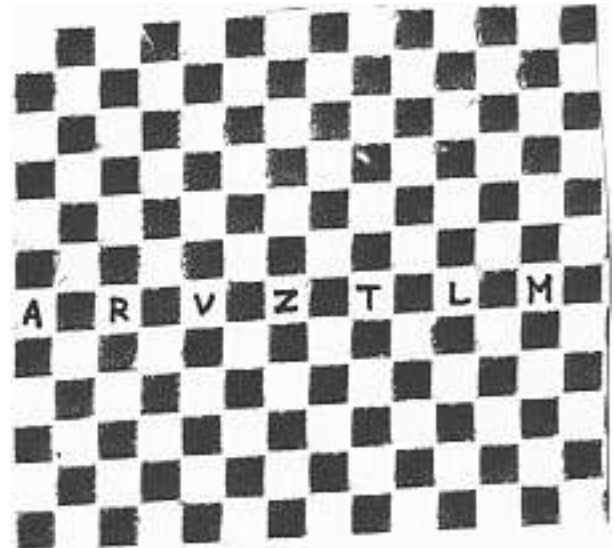

3

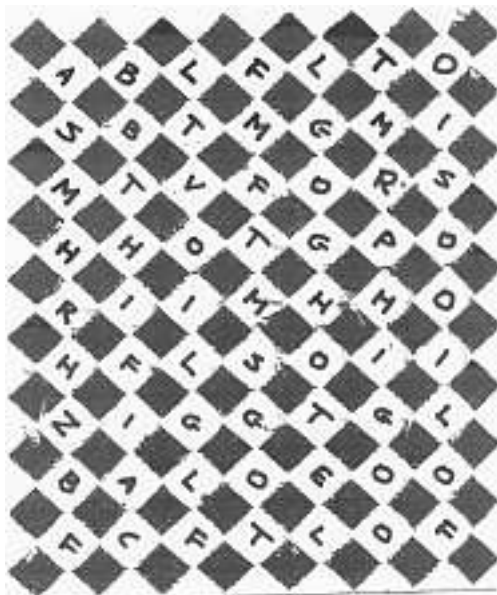

1

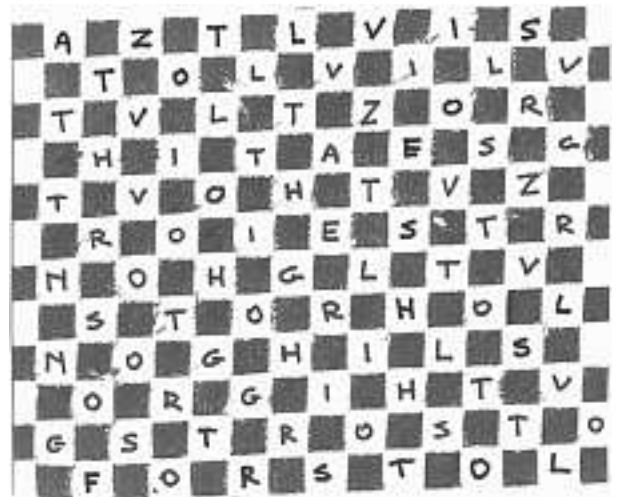

4

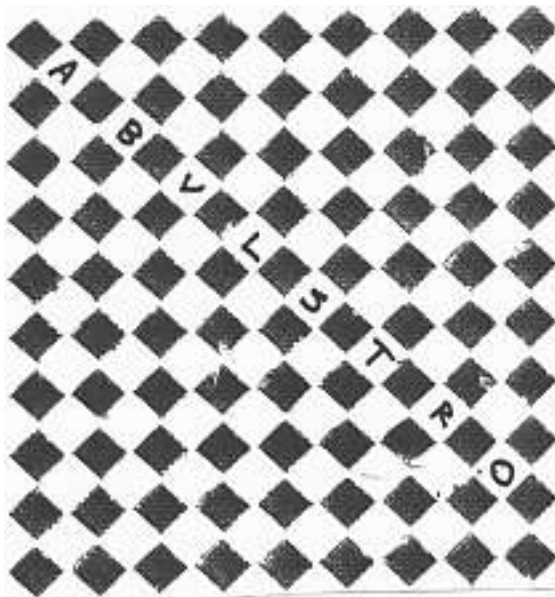

2

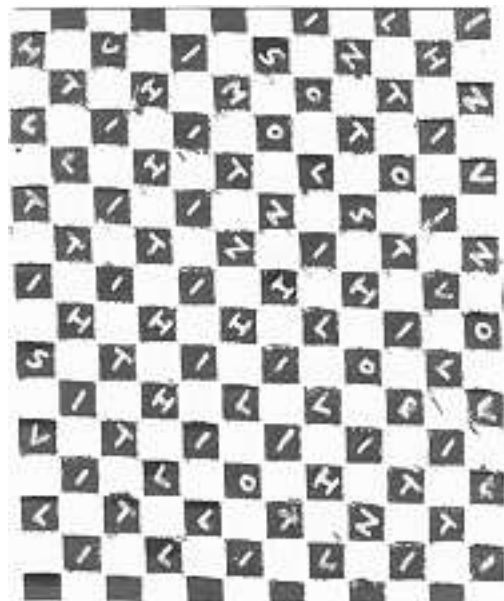

5

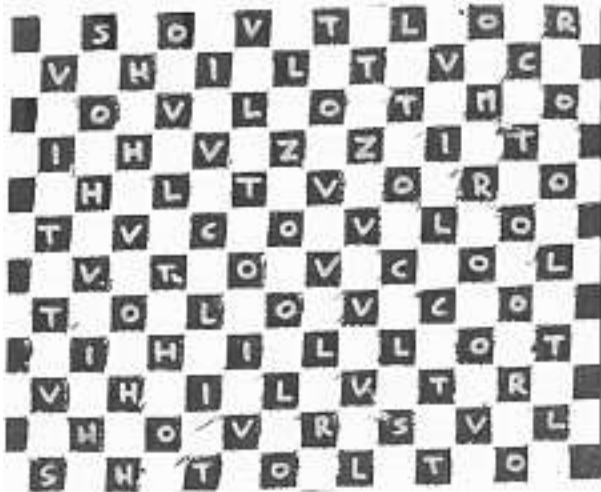

6

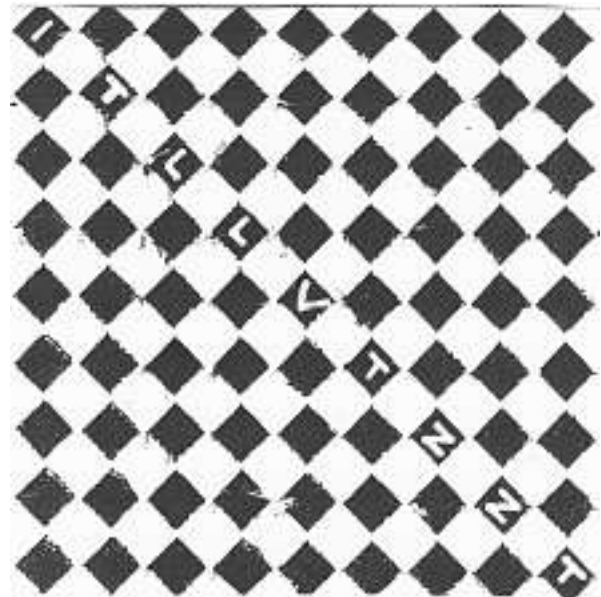

7

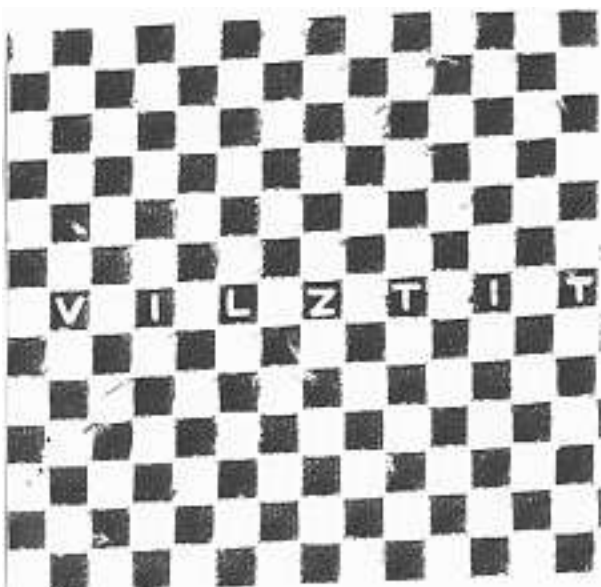

8

Cl. 05-05 **131 685** 21.04.2005
 21 Design – Gewebe (Textilien)
 Hinterleger: Sonntex Freizeitprodukte GmbH,
 Industriestrasse 20, Melsungen, DE
 Designer: Christa Mieves, Krefeld; Ulrike Beckmann, Willich;
 Bettina Martin, Moers; Elfriede Meyer, Pommelsbrunn
 Vertreter: Bovard AG, 3000 Bern 25
 Priorität: EM, 29.10.2004

(siehe Farbteil Heftmitte)

Cl. 05-06 **131 686** 06.04.2005
 4 Design – Verpackungsfolien
 Hinterleger: Ritz AG, 3177 Laupen
 Designer: Yves Borel, Bern



013



014



043



044

Cl. 06-01 **131 687** 01.04.2005
 4 Design – Polstermöbel
 Hinterleger: Rolf Benz AG & Co. KG, Haiterbacher Strasse 104,
 72202 Nagold, DE
 Designer: Anita Schmidt, Bretten; Christian Werner,
 Hollenstedt/Appel
 Vertreter: Bovard AG, 3000 Bern 25
 Priorität: EM, 22.11.2004; EM, 22.11.2004; EM, 22.11.2004;
 EM, 22.11.2004



300474 (1)



300474 (2)



300474 (3)





300474 (4)



Insel

Cl. 06-01 **131 688** 08.04.2005
 1 Design – Bank
 Hinterleger: Anton Lengen, Bergstrasse 12,
 8142 Uitikon-Waldegg
 Vertreter: Dario Zarro, 8047 Zürich



Cl. 06-01 **131 689** 13.04.2005
 1 Design – Stuhl
 Hinterleger: Fritz Aeschbacher, Möbelschreinerei, Jucher 69a,
 3036 Detligen
 Designer: Fritz Aeschbacher, Detligen





Vision

Cl. 06-01 131 690 13.04.2005
1 Design – Sessel
Hinterleger: Vitra Patente AG, Klünenfeldstrasse 22,
4132 Muttenz
Designer: Greg Lynn, Venice
Vertreter: AXON Patent GmbH, 4147 Aesch





1

Cl. 06-01 **131 691** 13.04.2005
 1 Design – Sofa
 Hinterleger: Vitra Patente AG, Klüfenfeldstrasse 22,
 4132 Muttenz
 Designer: Hella Jongerius, Rotterdam
 Vertreter: AXON Patent GmbH, 4147 Aesch



1

Cl. 06-03 **131 692** 13.04.2005
 1 Design – Tisch
 Hinterleger: Vitra Patente AG, Klüfenfeldstrasse 22,
 4132 Muttenz
 Designer: Maarten Van Severen, Gent
 Vertreter: AXON Patent GmbH, 4147 Aesch





1

Cl. 06-03 131 693 13.04.2005
2 Design – Tische
Hinterleger: Vitra Patente AG, Klünenfeldstrasse 22,
4132 Muttenz
Designer: Maarten Van Severen, Gent
Vertreter: AXON Patent GmbH, 4147 Aesch



1



2

Cl. 06-03 131 694 13.04.2005
 1 Design – Tisch
 Hinterleger: Vitra Patente AG, Klünenfeldstrasse 22,
 4132 Muttenz
 Designer: Philippe Starck, Paris
 Vertreter: AXON Patent GmbH, 4147 Aesch



1

Cl. 06-04 131 696 13.04.2005
 2 Design – Möbelregale
 Hinterleger: Vitra Patente AG, Klünenfeldstrasse 22,
 4132 Muttenz
 Designer: Maarten Van Severen, Gent
 Vertreter: AXON Patent GmbH, 4147 Aesch



1



2

Cl. 06-13 131 697 23.03.2005
 2 Design – Serviette, Tischset
 Hinterleger: Ilona Hug, Rankried 10, 6048 Horw



1

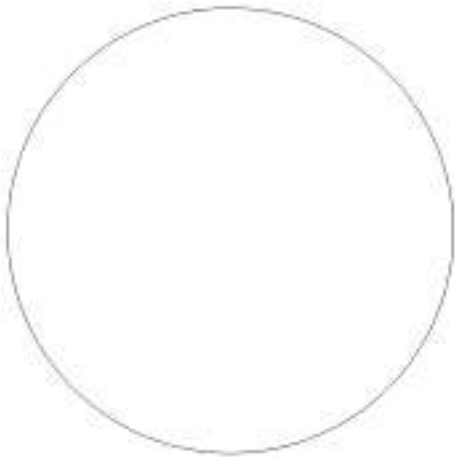

2

Cl. 06-13 **131 698** 25.04.2005
 2 design – housse pour coussins
 Déposant: Fashy GmbH Produktion und Vertrieb
 Gummi-Kraus, Kornwestheimer Strasse 46,
 70825 Korntal-Münchingen, DE
 Designer: Christel Koch, Stuttgart
 Mandataire: Micheli & Cie, 1226 Thônex (Genève)
 Priorité: EM, 02.02.2005
 (siehe Farbteil Heftmitte)

Cl. 07-02 **131 699** 31.03.2005
 1 Design – Fonduecaquelon
 Hinterleger: Rolf Rudin, Im Zwiller 2, 4425 Titterten



Le trois Fondue

Cl. 07-02 **131 700** 06.05.2005
 1 design – pot pour chauffer le lait
 Déposant: Société des Produits Nestlé SA, 1800 Vevey
 Designer: Antoine Cahen, Lausanne
 Mandataire: Nestec S.A., 1800 Vevey





FL 57444

Cl. 08-03 **131 702** 11.04.2005
 2 Design – Griff für Handsäge
 Hinterleger: Kabushiki Kaisha Okada Kinzoku Kogyosho,
 (Okada Metal Industries Co., Ltd.), 561, Omura, Miki-shi,
 Hyogo, JP
 Designer: Tamotsu Okada, Hyogo
 Vertreter: A. Braun, Braun, Héritier, Eschmann AG,
 Patentanwälte, 4051 Basel

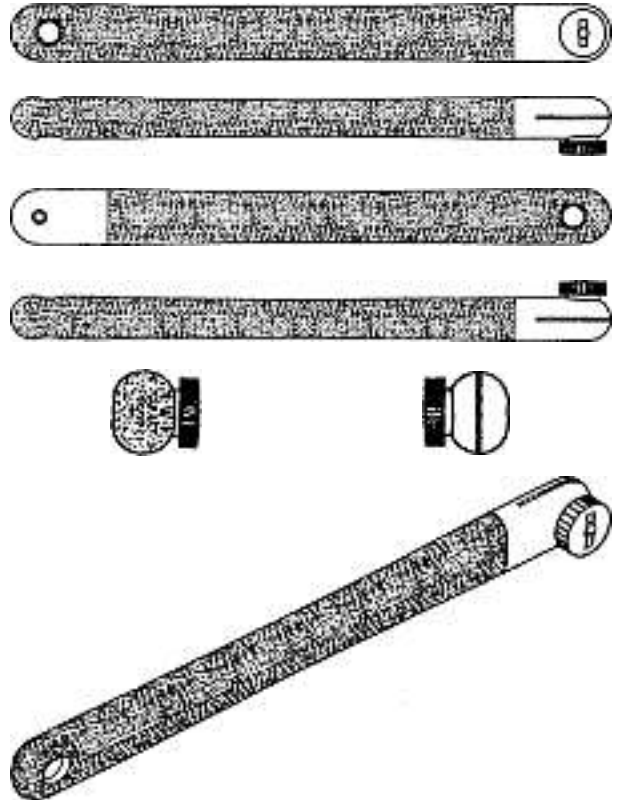

D. 7/2005-1

Cl. 07-04 **131 701** 23.03.2005
 1 Design – Fruchtpresse
 Hinterleger: Sami Hamida, Jupiterstrasse 25/729, 3015 Bern;
 Mohammad Basir Bahmanpour, Kappelenring 10,
 3032 Hinterkappelen
 Vertreter: Sami Hamida, 3015 Bern

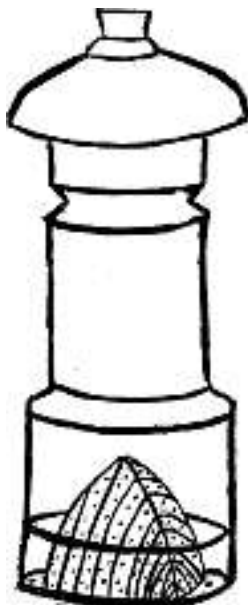

Lemonsqueezer

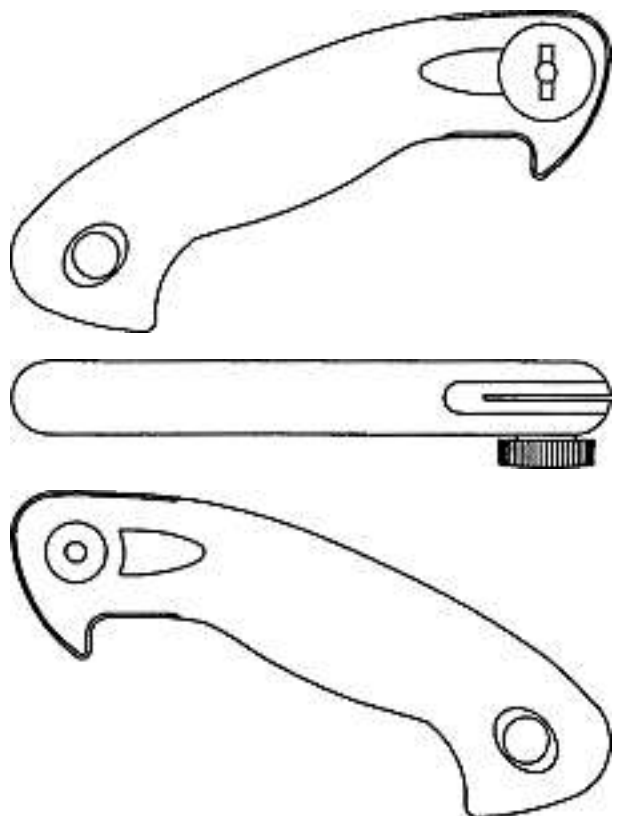

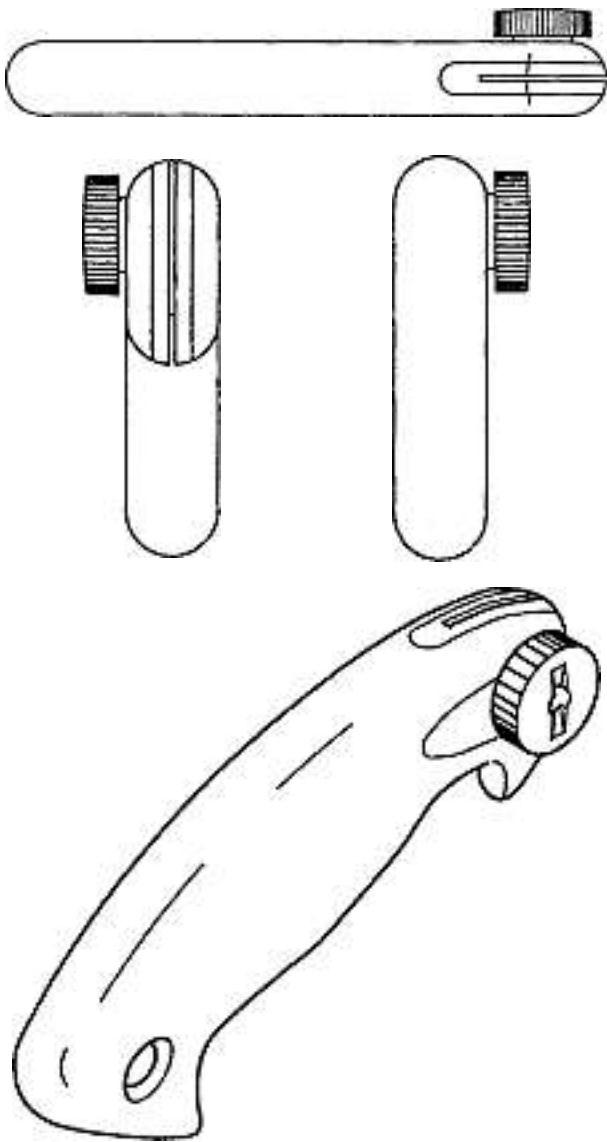

D. 7/2005-2

Cl. 08-07 **131 703** 22.03.2005
12 Design – Verriegelungsmulde
Hinterleger: Planet GDZ AG, Eigentalstrasse 7,
8309 Nürens Dorf
Designer: Andreas Dintheer, Nürens Dorf
Vertreter: Isler & Pedrazzini AG, 8023 Zürich

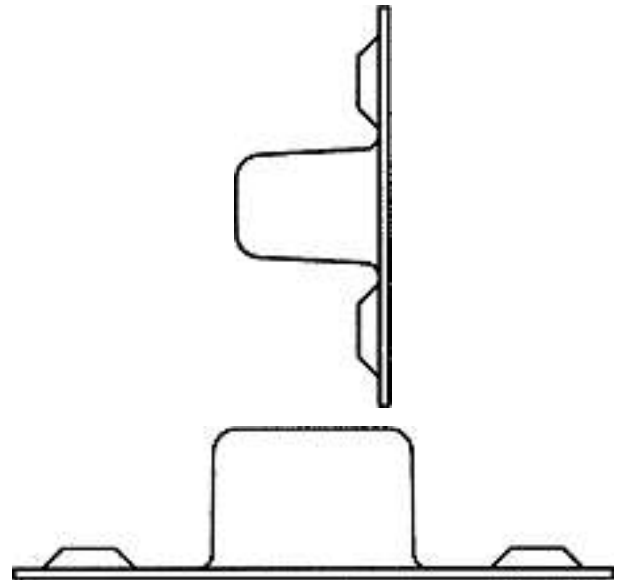
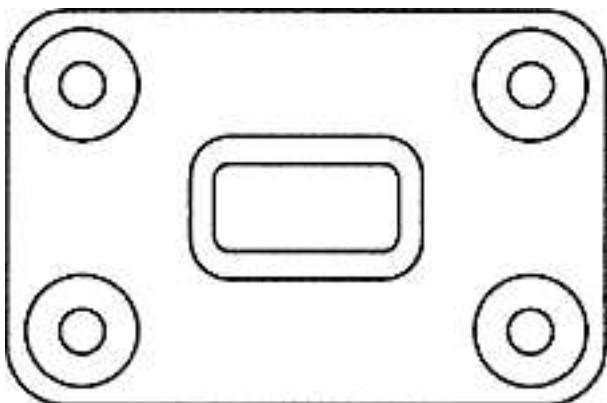

1

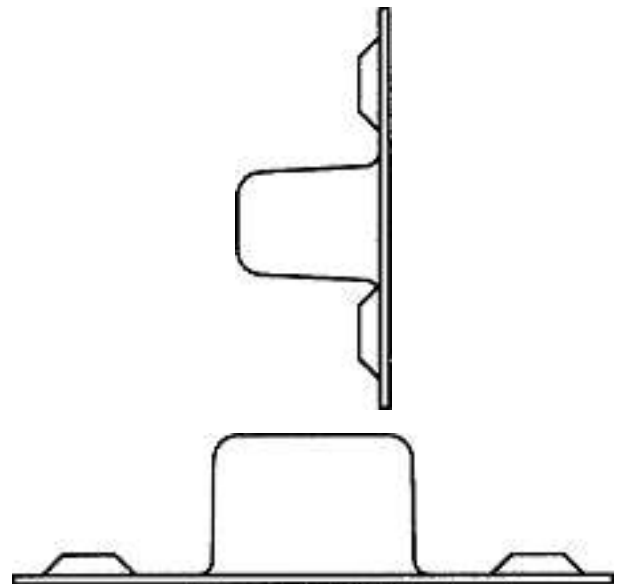
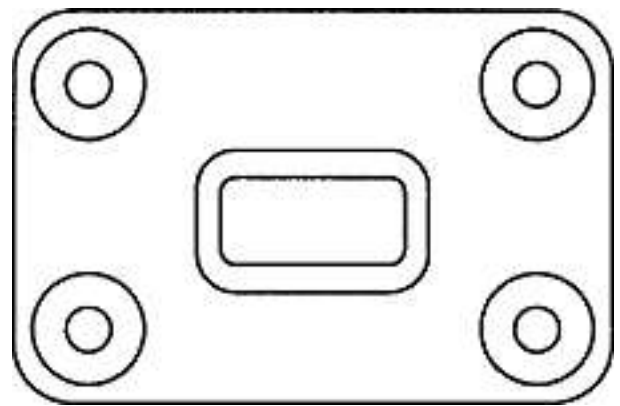

2

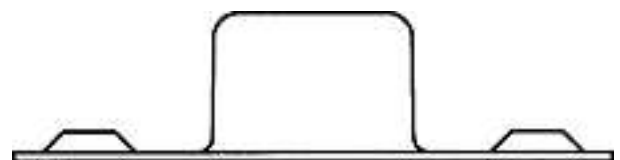

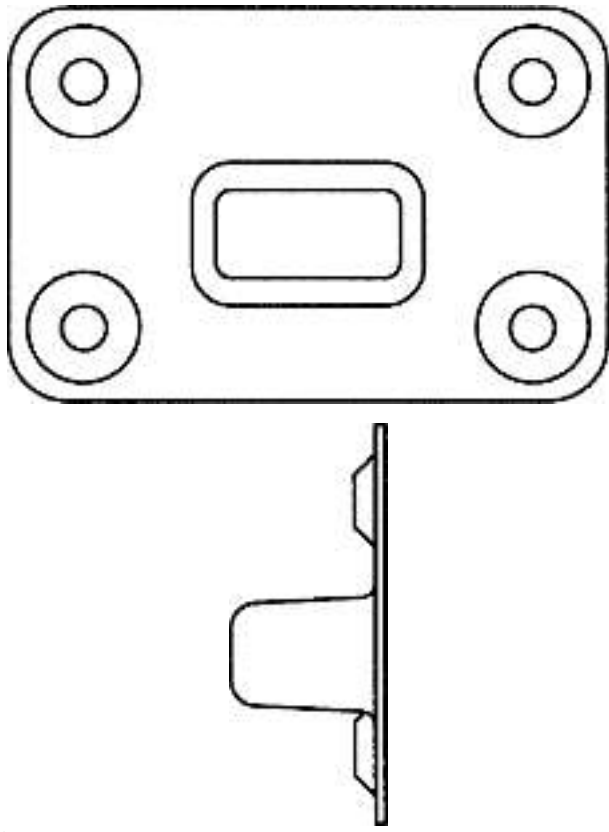

3

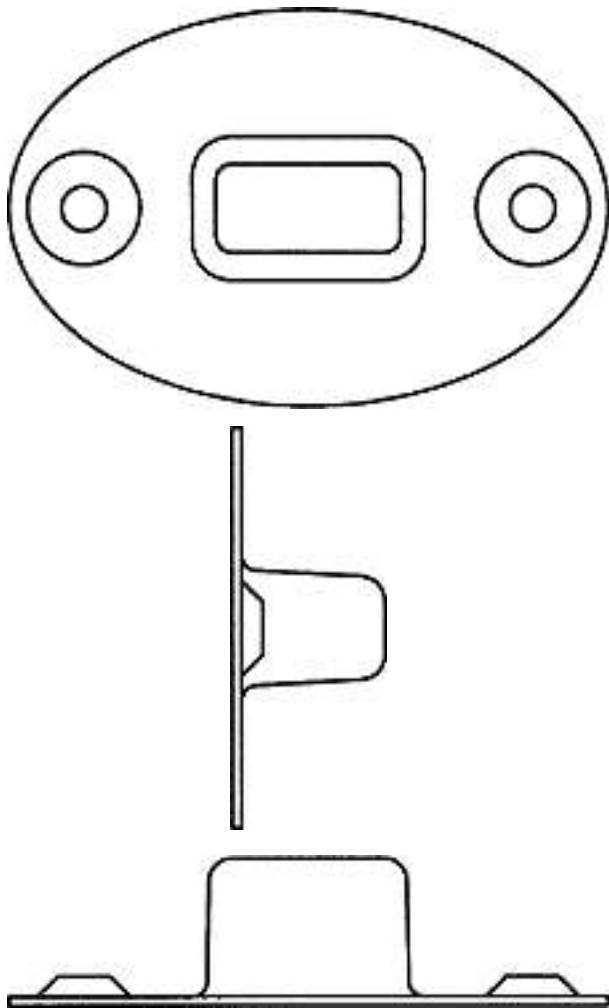

4

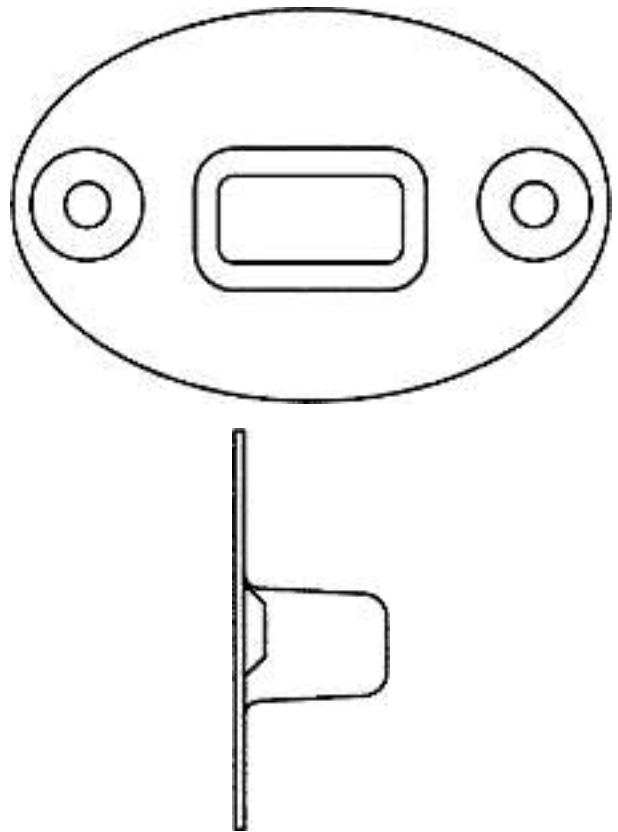

5

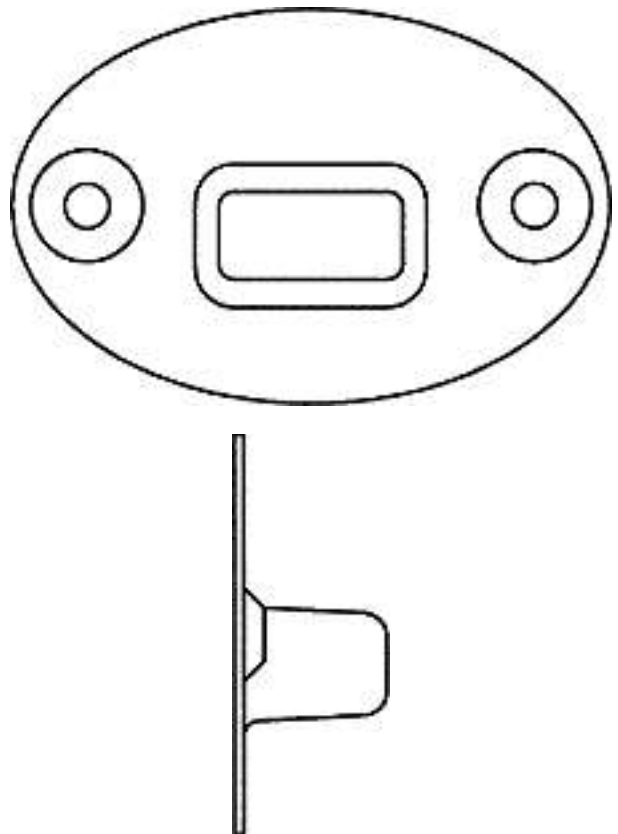

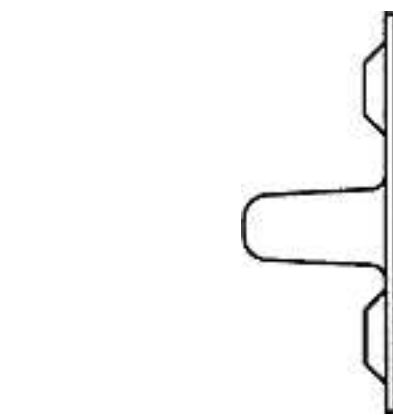
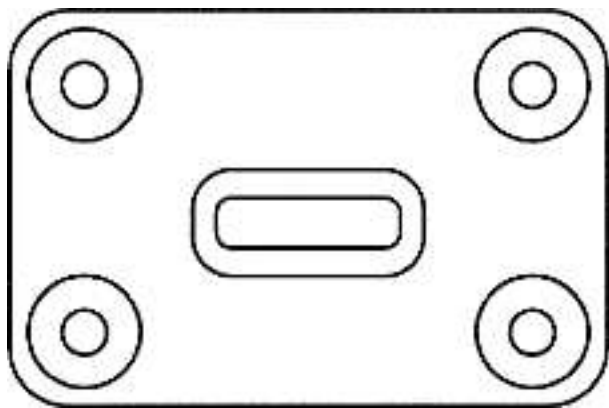
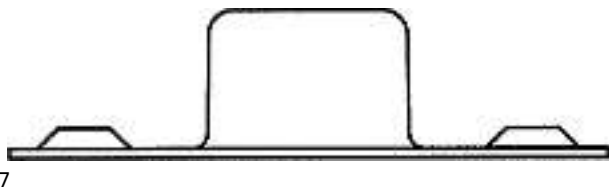
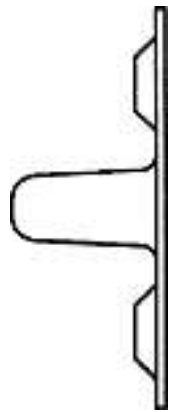
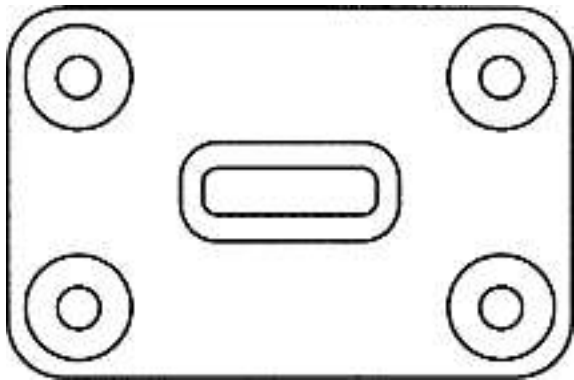
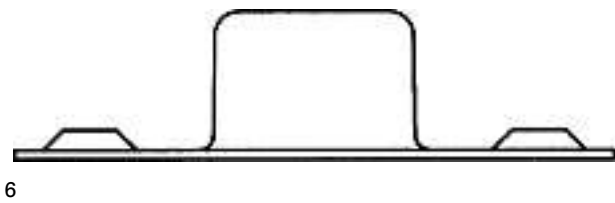

8

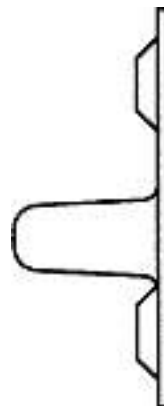
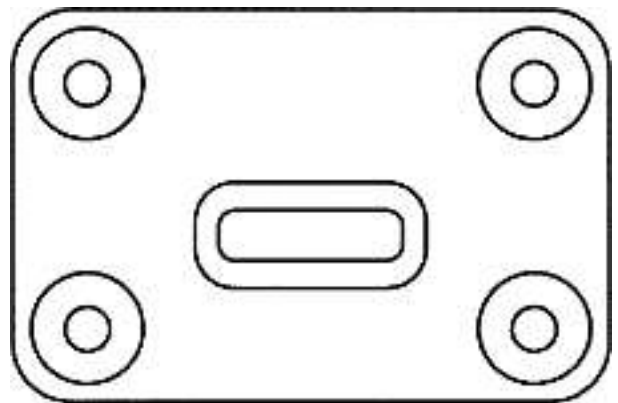

9

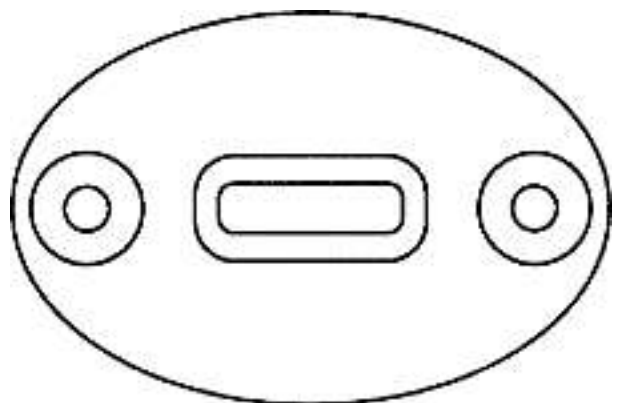

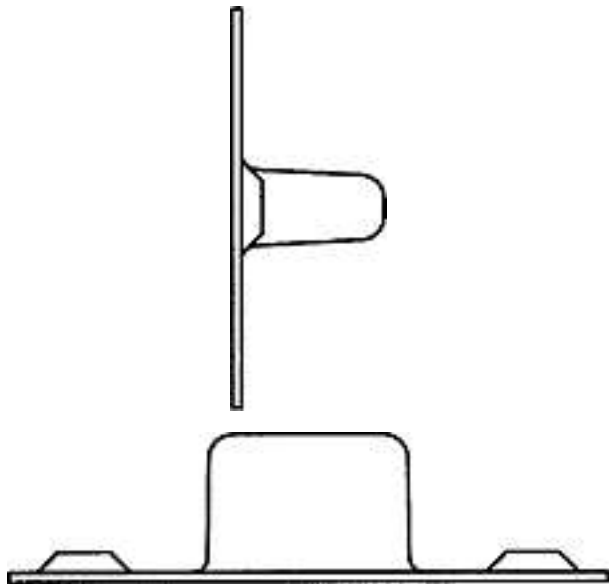

10

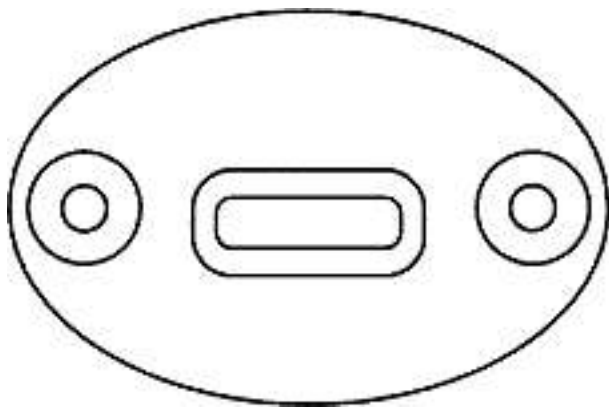

11

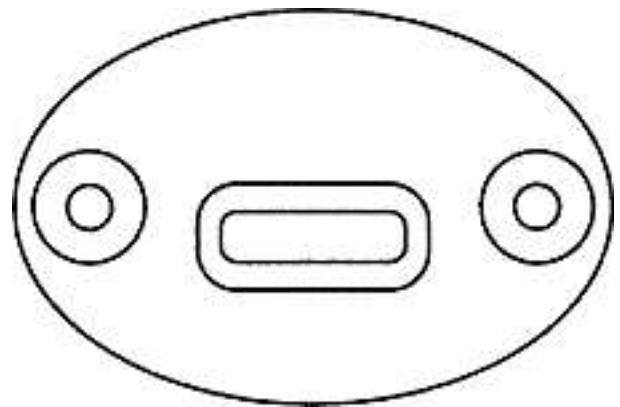
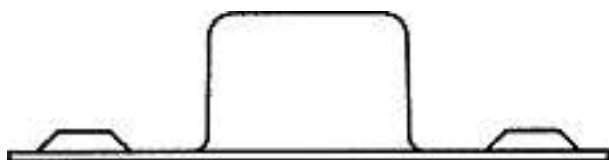
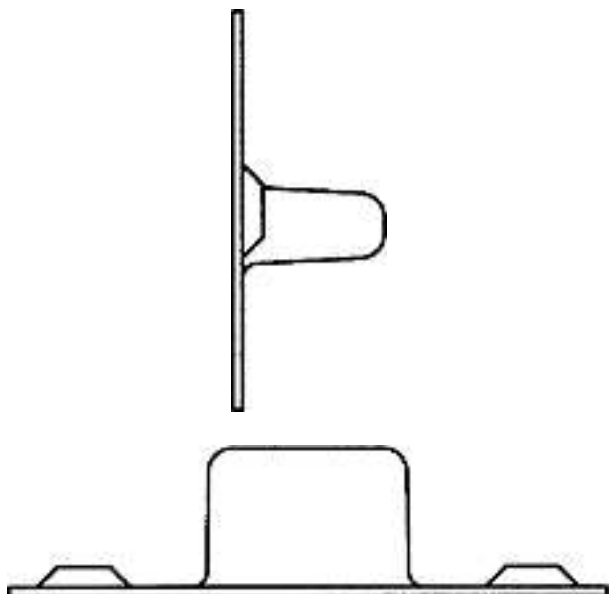

12

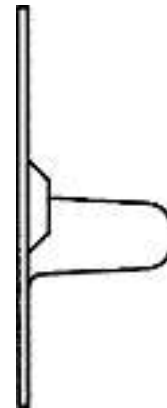

Cl. 08-07 **131 704** 07.04.2005

1 Design – Druckknopfschloss
 Hinterleger: Knaack Manufacturing Company, 420 East Terra
 Cotta Avenue, Crystal Lake, IL 60014, US
 Designer: Tom Schwalie, Crystal Lake; Randy Hyde,
 Crystal Lake
 Vertreter: Isler & Pedrazzini AG, 8023 Zürich
 Priorität: US, 13.10.2004

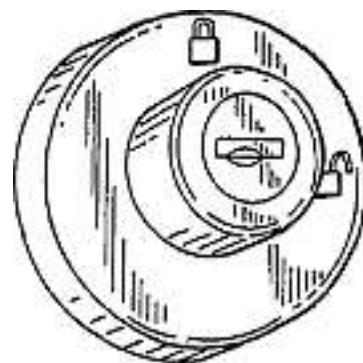

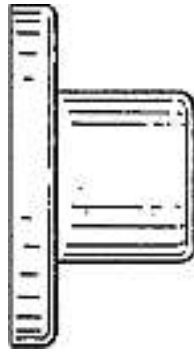

M13018

Cl. 08-08 131 705 04.04.2005
 1 Design – Schlauchbrücke
 Hinterleger: Rex Articoli Tecnici SA, Via Catenazzi 1,
 6850 Mendrisio
 Designer: Marco Favini, Salorino
 Vertreter: Hans Rudolf Gachnang, 8501 Frauenfeld

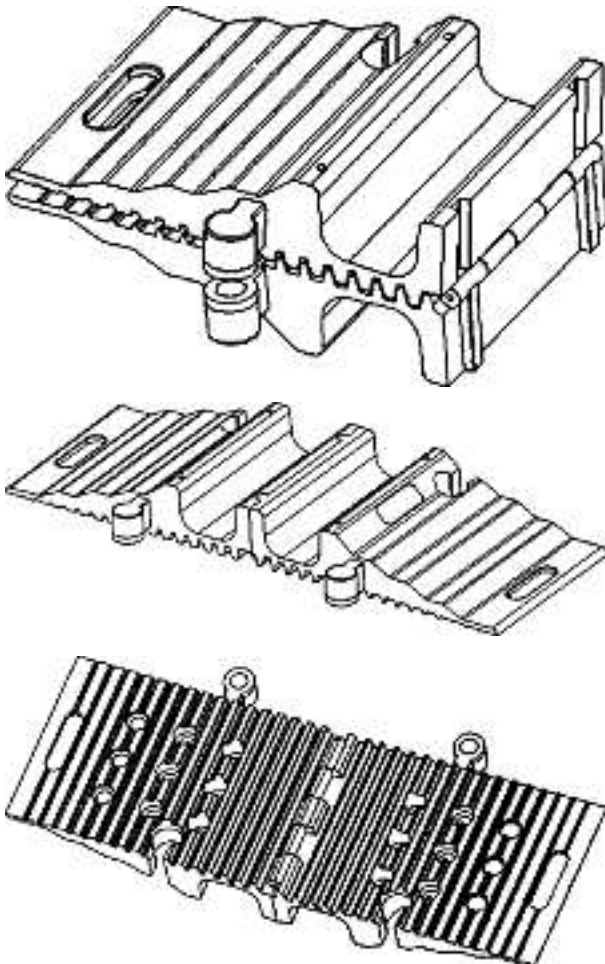

1

Cl. 09-03 131 706 23.03.2005
 4 Design – Verpackung
 Hinterleger: Bledina, 383, rue Philippe Héron,
 69400 Villefranche-sur-Saône, FR
 Designer: Laurence Morin, Paris
 Vertreter: E. Blum & Co., 8044 Zürich
 A-2005/1013a (siehe Farbteil Heftmitte)
 A-2005/1013b (siehe Farbteil Heftmitte)
 A-2005/1013c (siehe Farbteil Heftmitte)
 A-2005/1013d (siehe Farbteil Heftmitte)

Cl. 09-03 131 707 05.04.2005
 1 Design – Verpackung
 Hinterleger: Mars, Incorporated, A Delaware Corporation,
 6885 Elm Street, McLean/VA, US
 Designer: Uwe Nehus, Verden (Aller)
 Vertreter: A.W. Metz & Co. AG, 8024 Zürich
 Priorität: EM, 21.12.2004

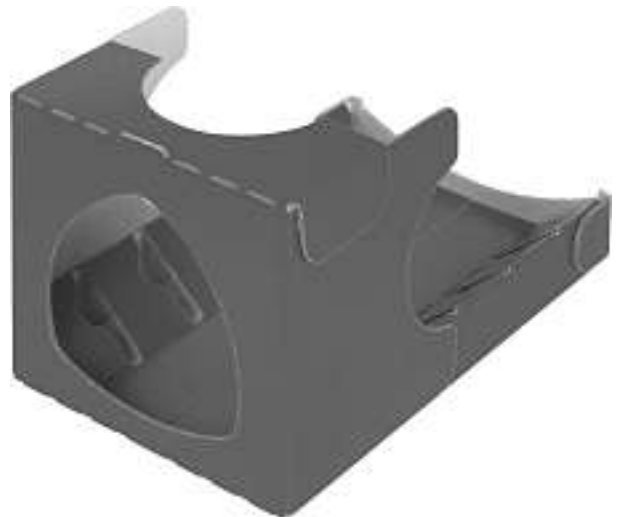

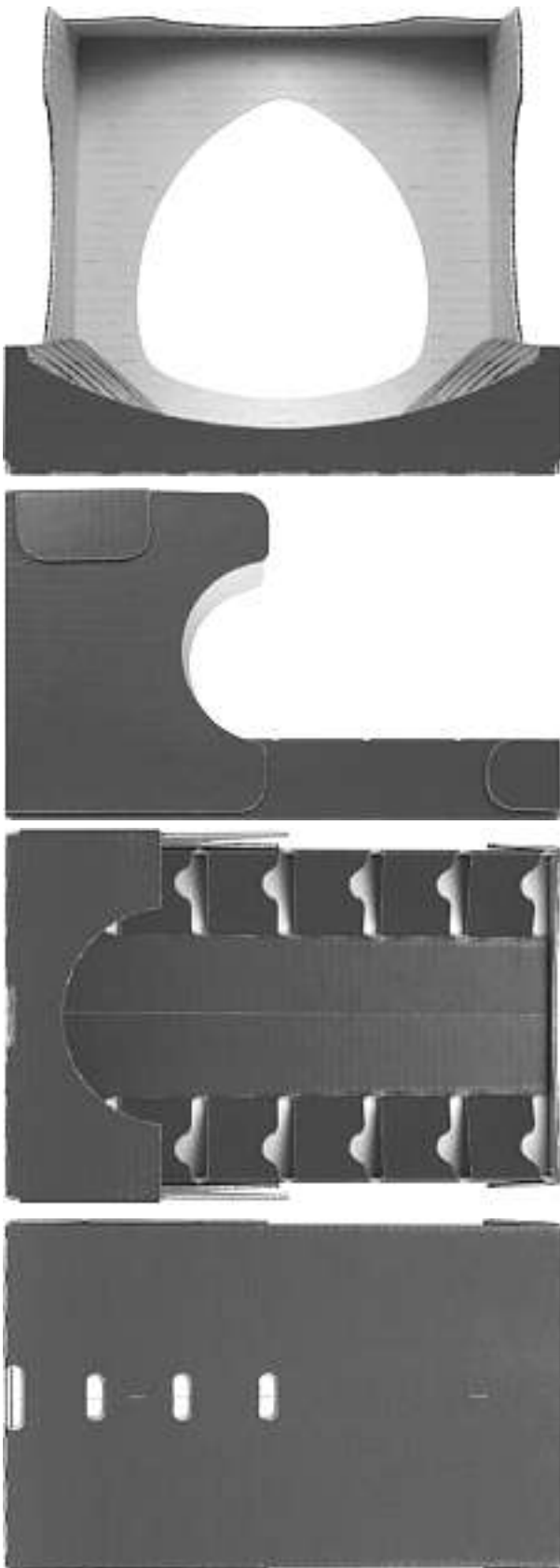

50896-CH-20-DK

Cl. 09-03 **131 708** 07.04.2005
 1 Design – Lastwagenkistenabdeckung
 Hinterleger: Knaack Manufacturing Company, 420 East Terra
 Cotta Avenue, Crystal Lake, IL 60014, US
 Designer: Tom Schwalie, Crystal Lake; Barry Bidinger,
 Palatine; Jerry Draffkorn, jun., Woodstock; Atul Saigal,
 Algonquin; Randy Hyde, Crystal Lake
 Vertreter: Isler & Pedrazzini AG, 8023 Zürich
 Priorität: US, 13.10.2004

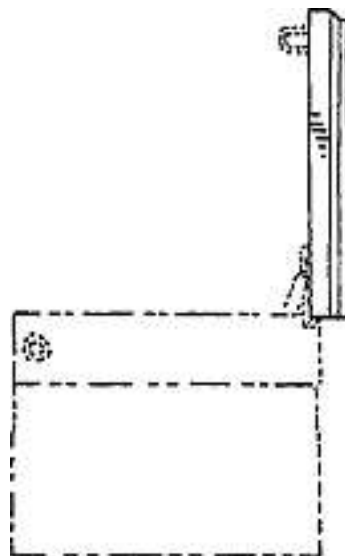
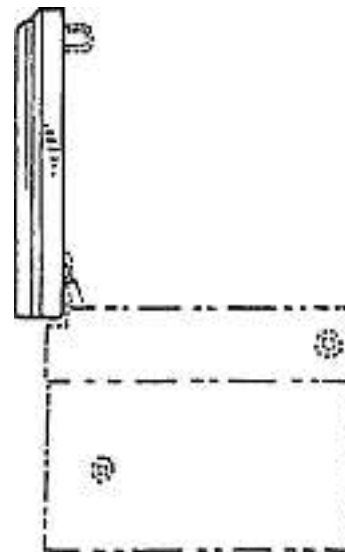
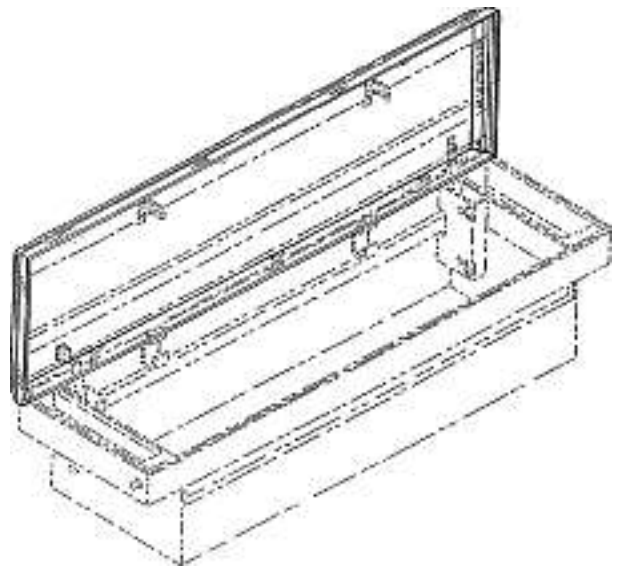

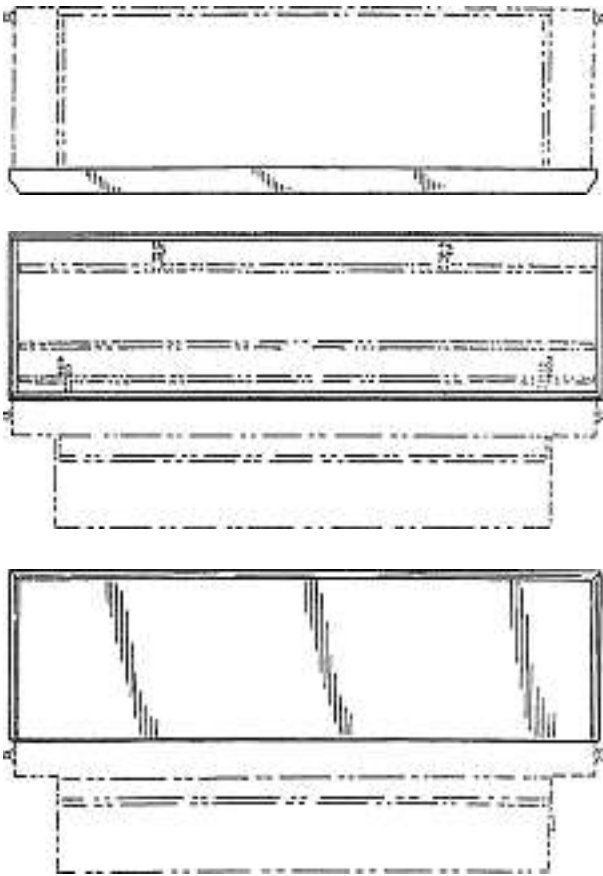

M13019

Cl. 09-03 131 709 13.04.2005
1 Design – Lastwagenkiste
Hinterleger: Knaack Manufacturing Company, 420 East Terra
Cotta Avenue, Crystal Lake, IL 60014, US
Designer: Tom Schwalie, Crystal Lake; Barry Bidingler,
Palatine; Jerry Draffkorn, jun., Woodstock; Atul Saigal,
Algonquin; Randy Hyde, Crystal Lake
Vertreter: Isler & Pedrazzini AG, 8023 Zürich
Priorität: US, 13.10.2004

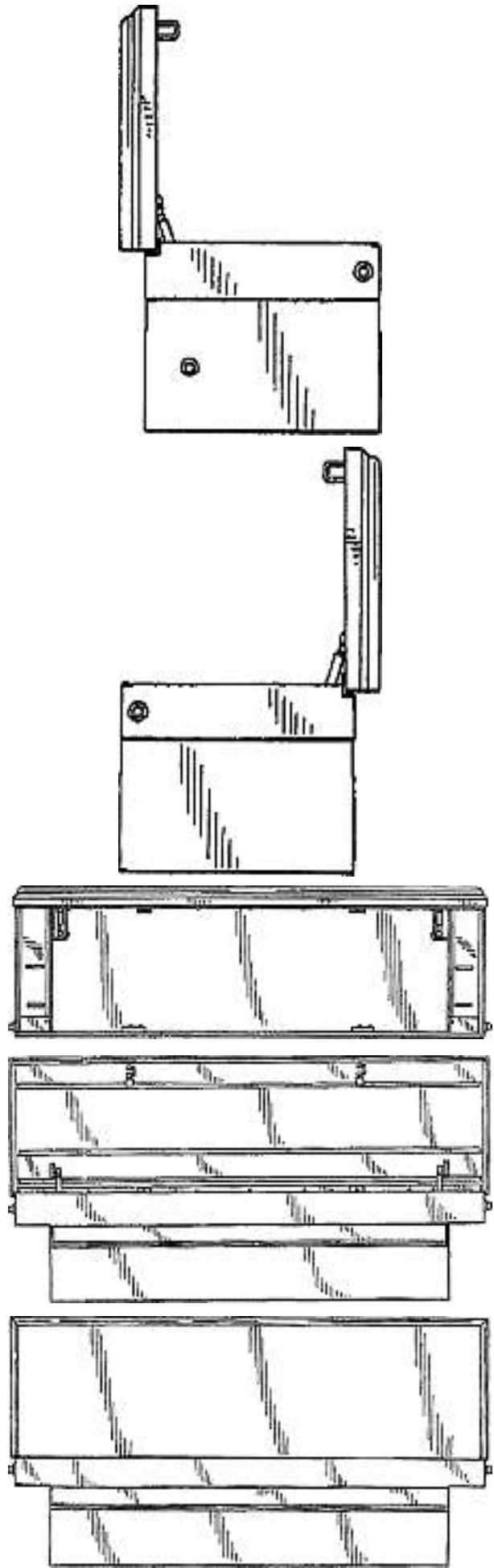
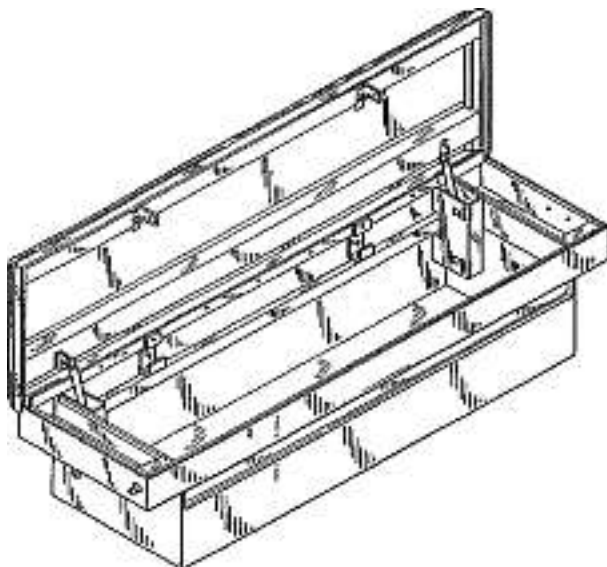
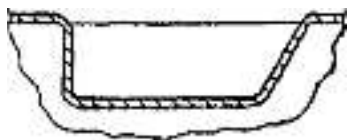



M13021

Cl. 10-02, 10-07 **131 710** 30.03.2005
 4 design – boîtier de montre, cadran de montre, bracelet de
 montre, montre
 Déposant: de Grisogono S.A., 176bis, Route de Saint-Julien,
 1228 Plan-les-Ouates
 Designer: Fawaz Gruosi, Prangins
 Mandataire: Griffes Consulting S.A., 1206 Genève

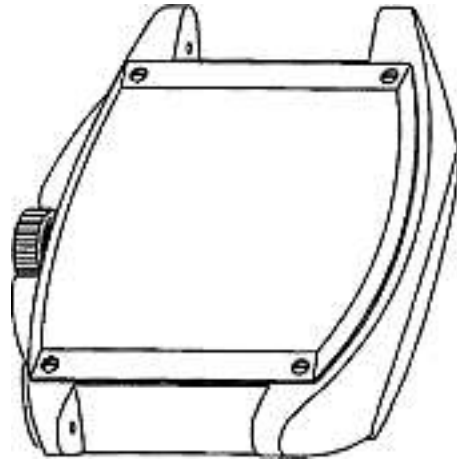
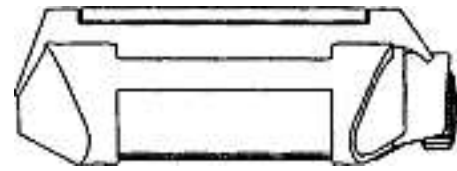
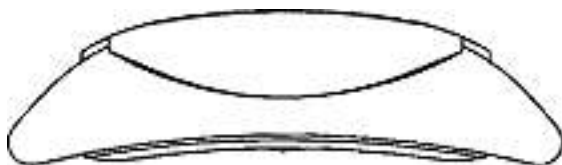
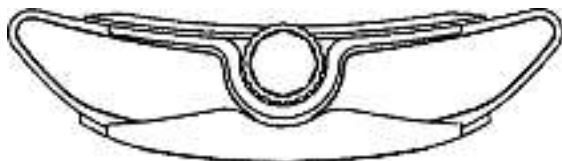
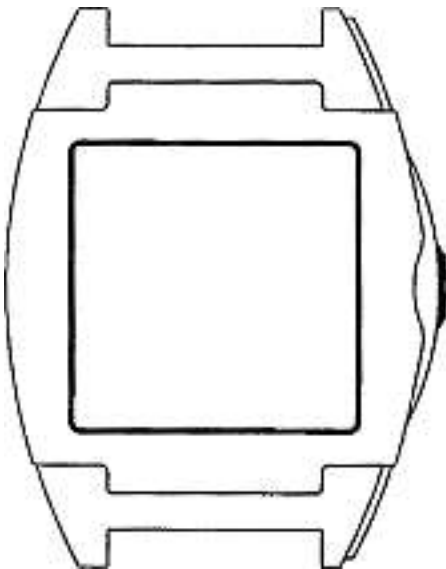
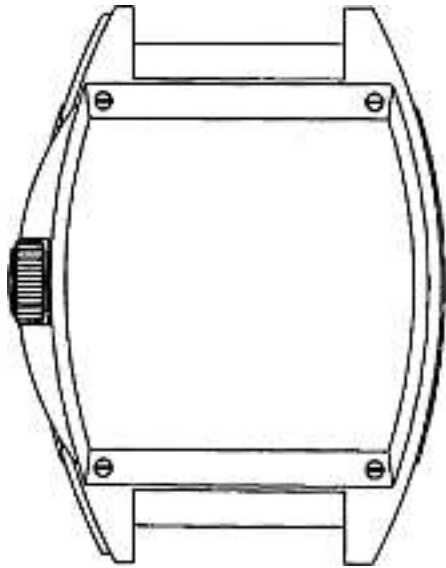

MO-28753-CH

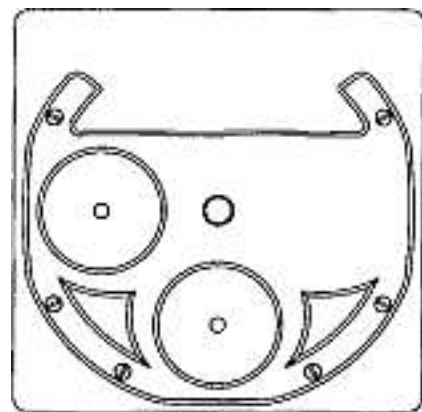

MO-28754-CH

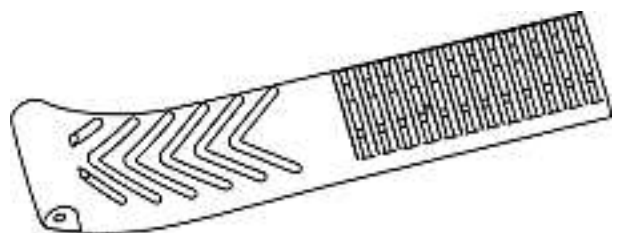

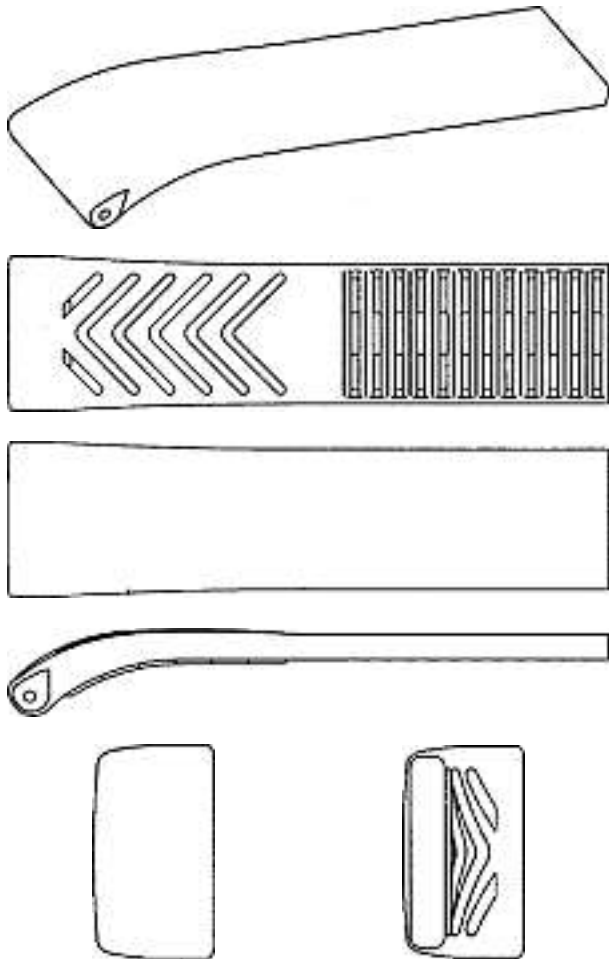

MO-28755-CH

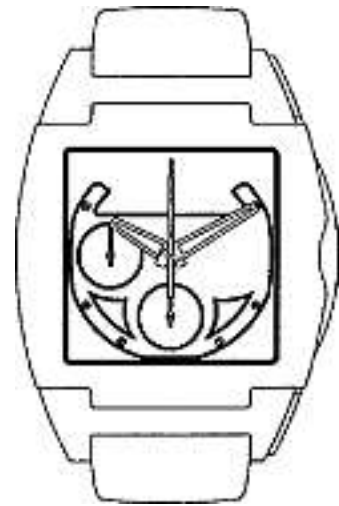
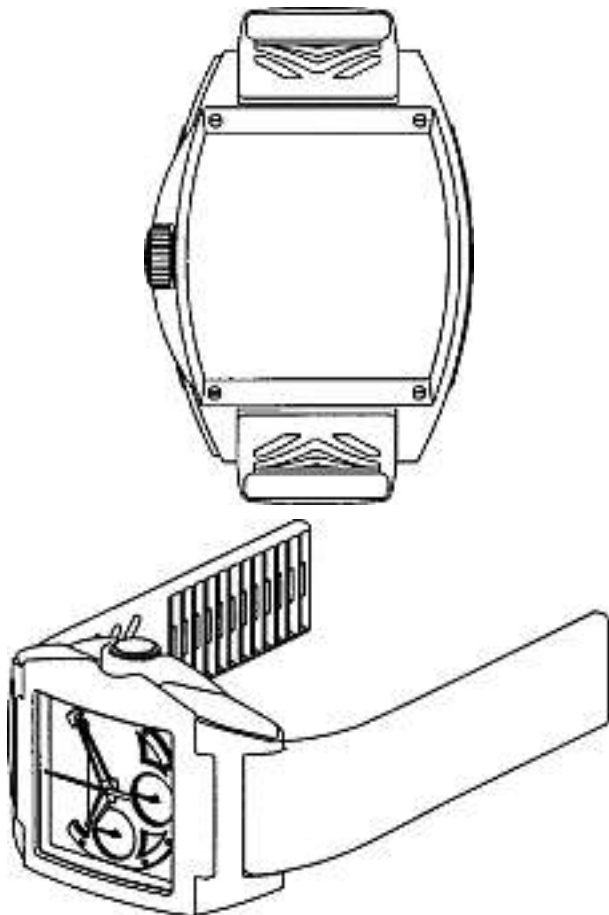

MO-28756-CH

Cl. 10-02, 10-07 131 711 01.04.2005
 5 design – montre, boîtiers de montre, bracelet de montre, cadran de montre
 Déposant: La Tête dans les Etoiles SA, 60 route de Malagnou, 1208 Genève
 Designer: Christian Goecking, Rolle
 Mandataire: Griffes Consulting S.A., 1206 Genève

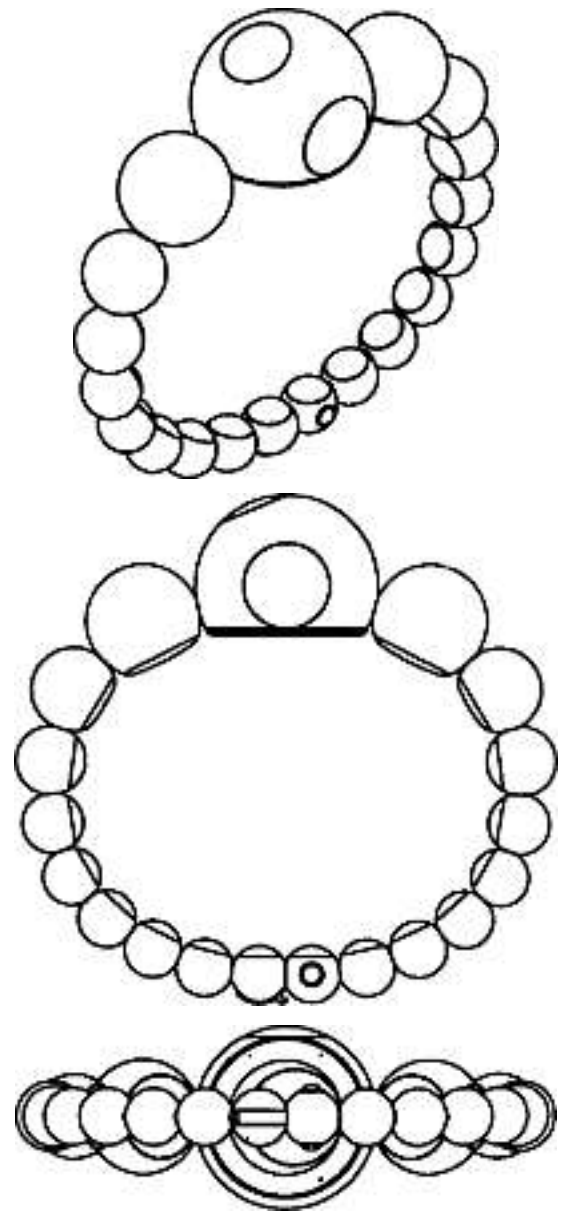

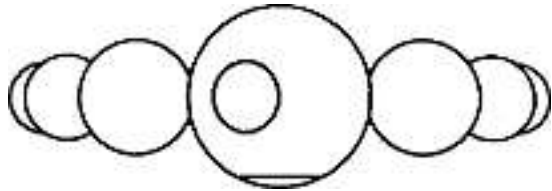
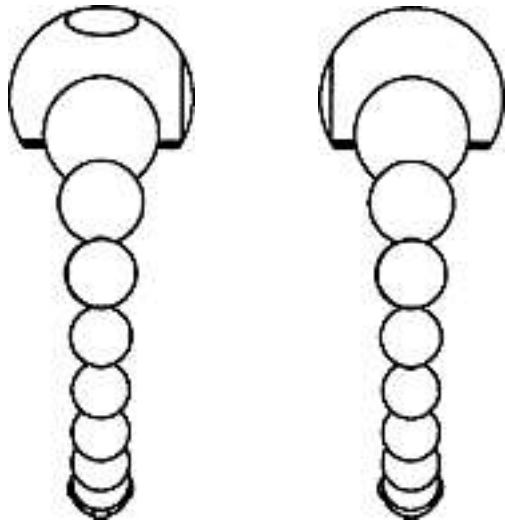

MO-126503-CH

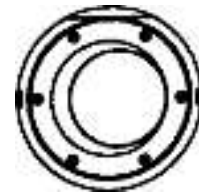
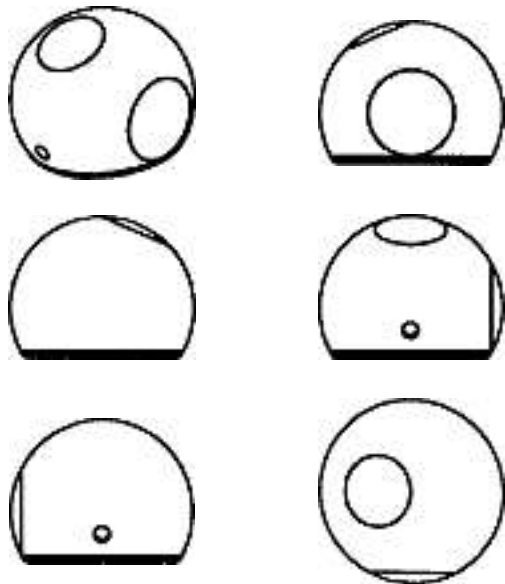

MO-126504-CH

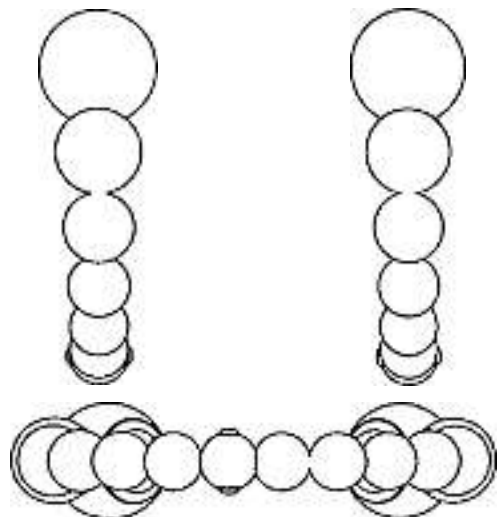
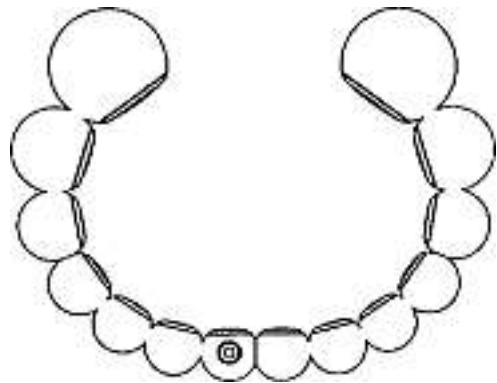
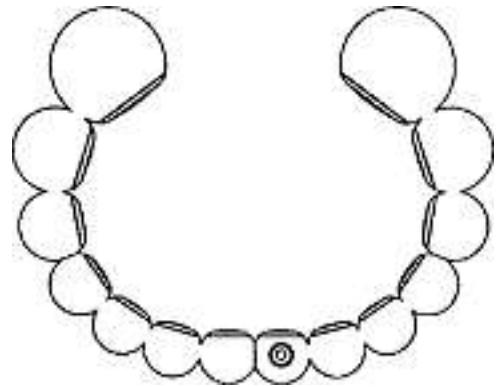
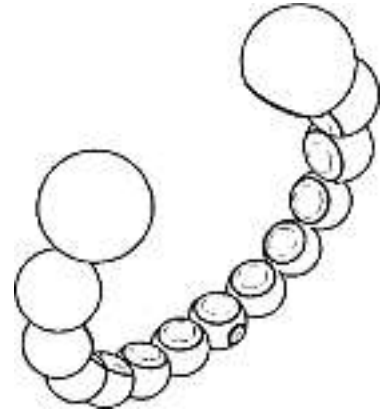



MO-126505-CH

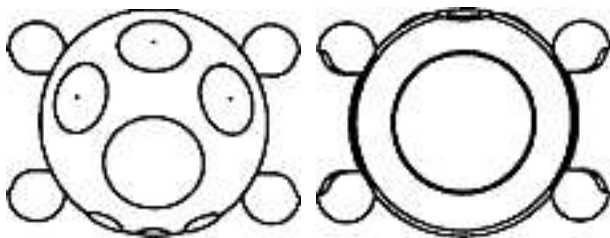
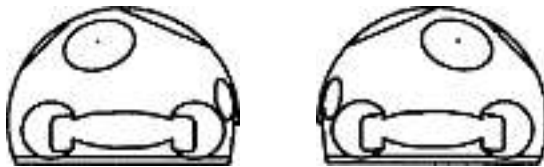
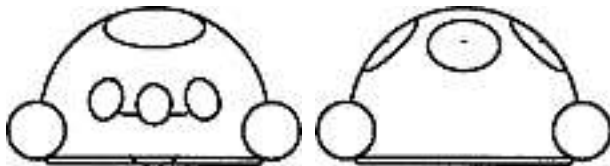
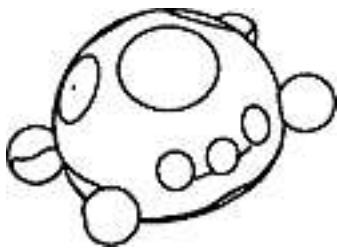

MO-126506-CH

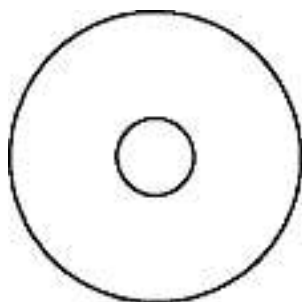
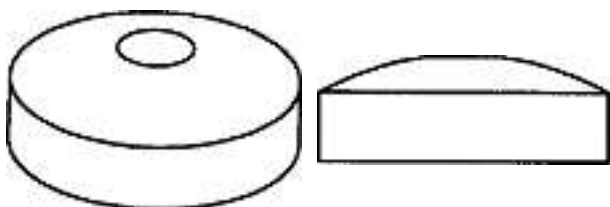

MO-126507-CH

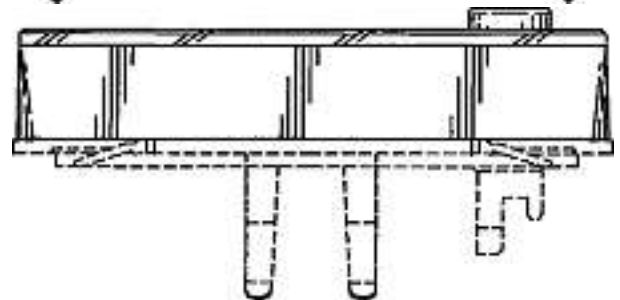
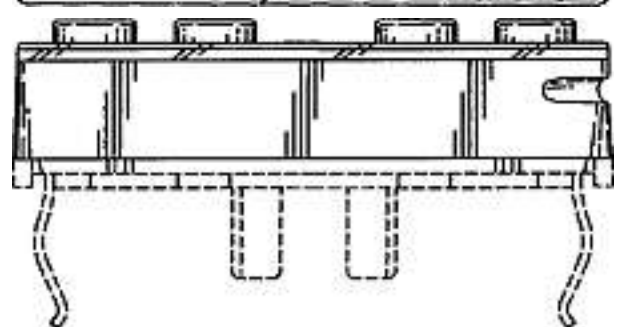
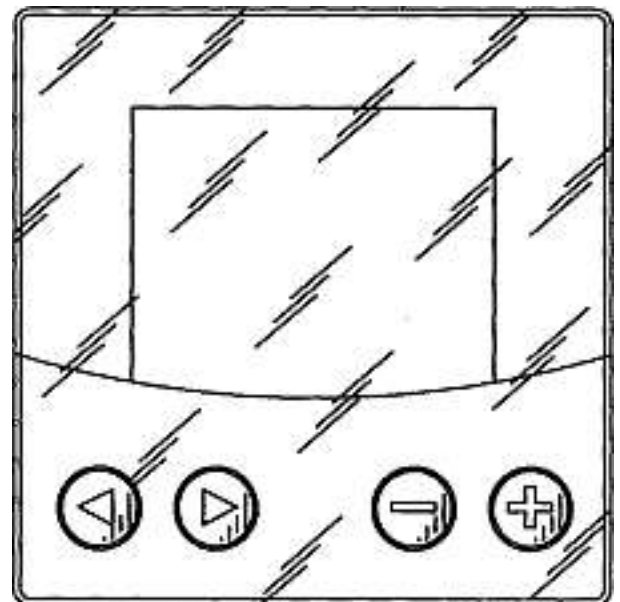
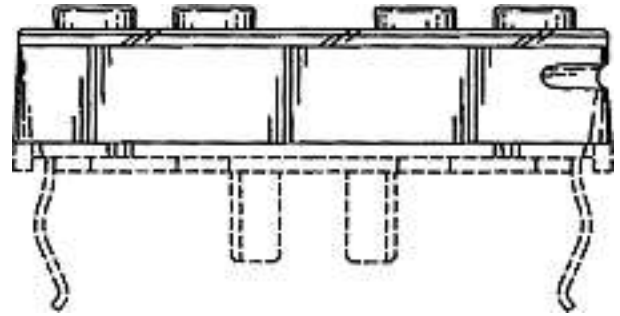
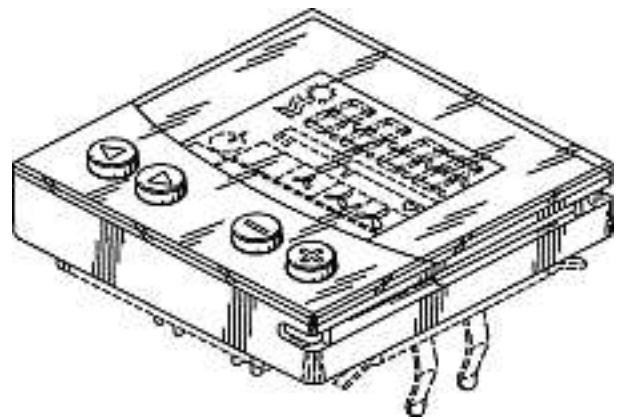

Cl. 10-05 **131 716** 06.04.2005
 4 Design – Gebäudeautomatisationsgerät
 Hinterleger: Siemens Schweiz AG, Albisriederstrasse 245,
 8047 Zürich
 Designer: Klaus Baumgartner, Sindelfingen; Matthias Decker,
 Esslingen; Mehrdad Misaghi, Jona-Lenggis
 Vertreter: Siemens Schweiz AG, 6300 Zug

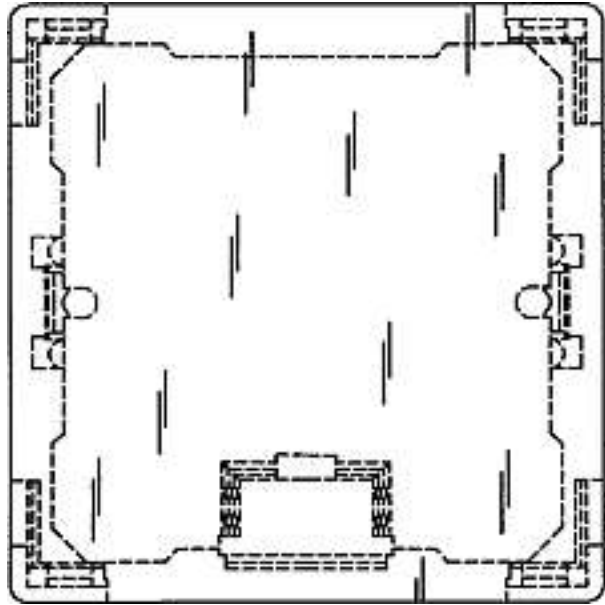
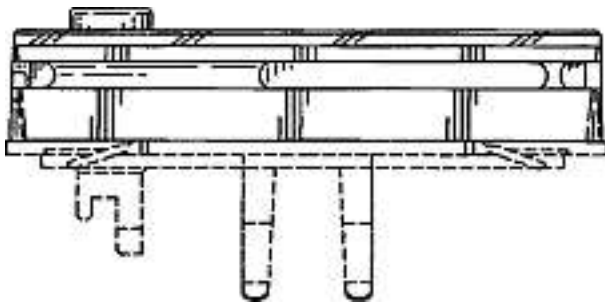

1

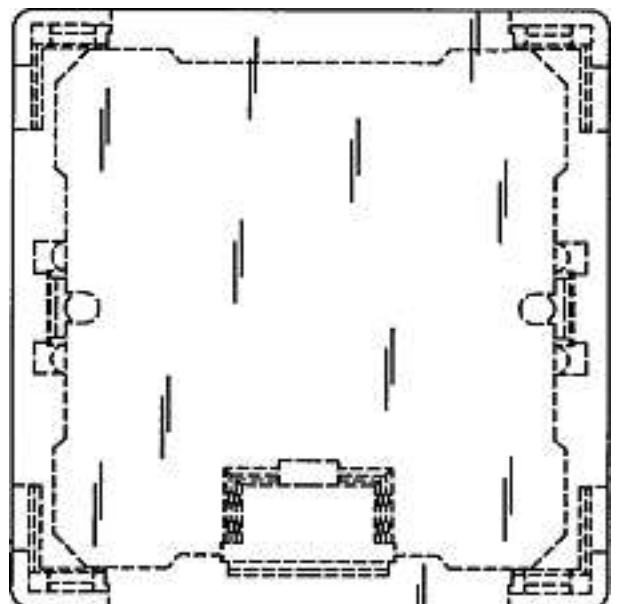
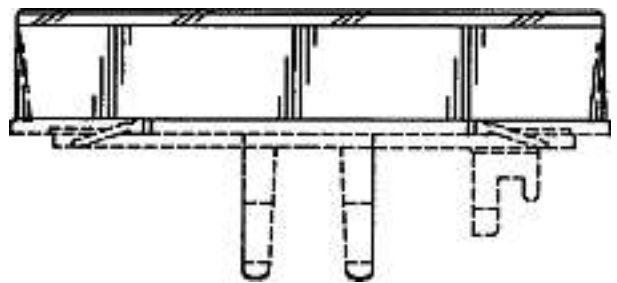
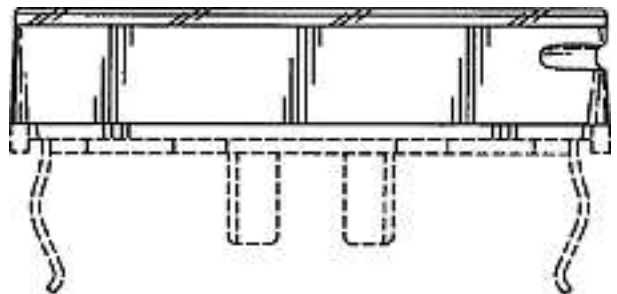
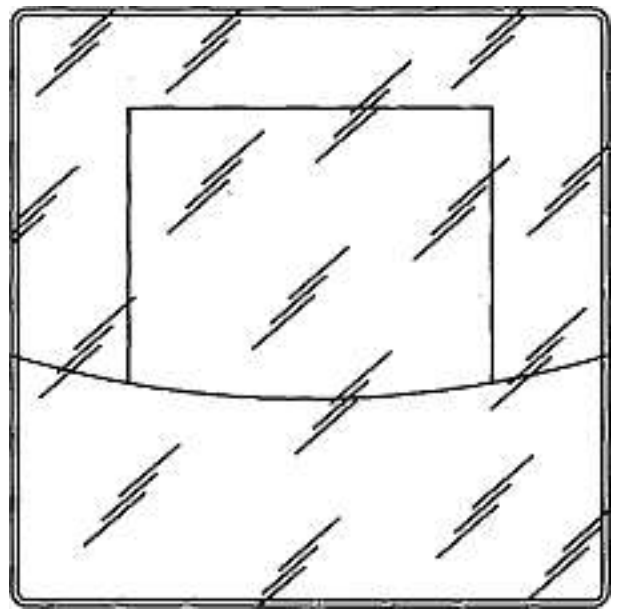
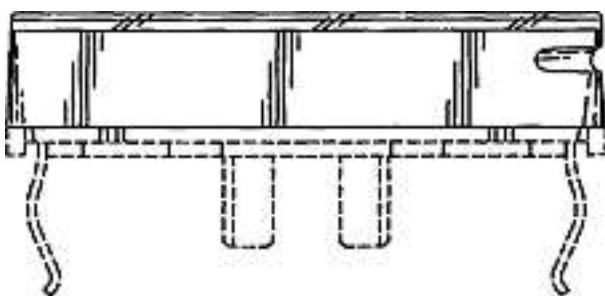
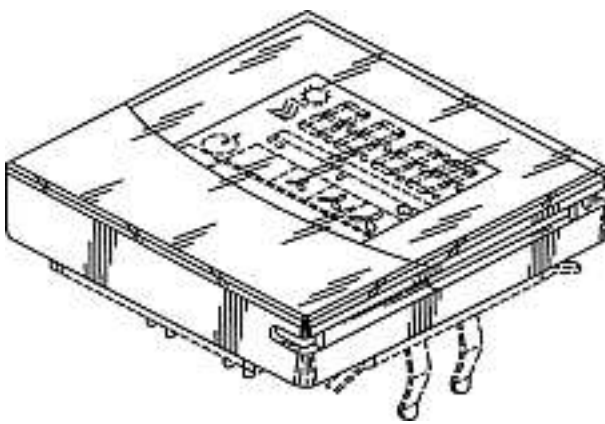

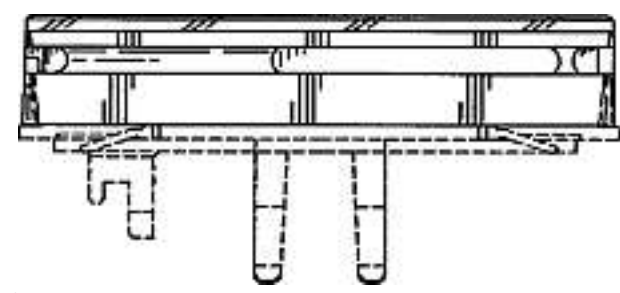

2

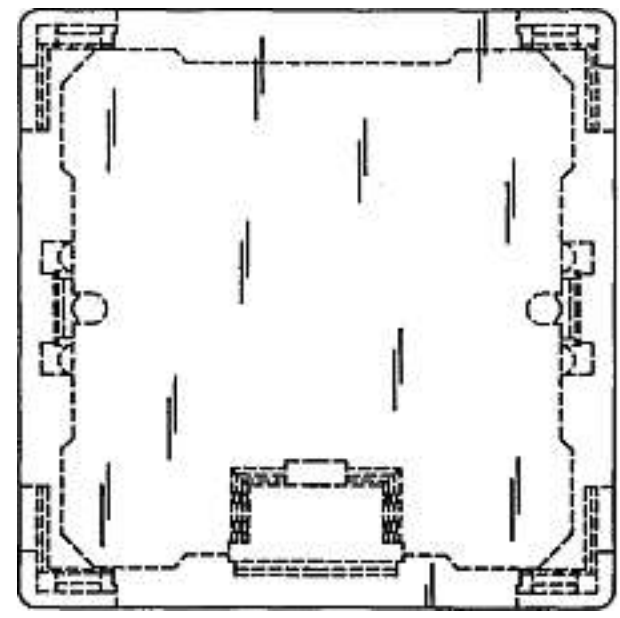
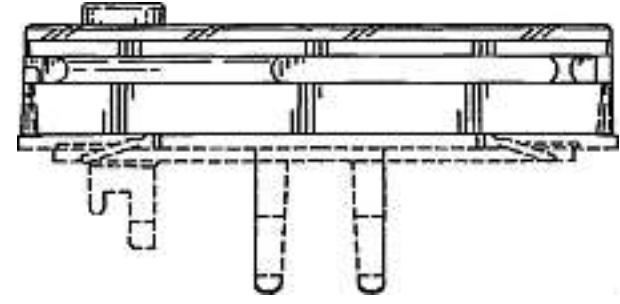
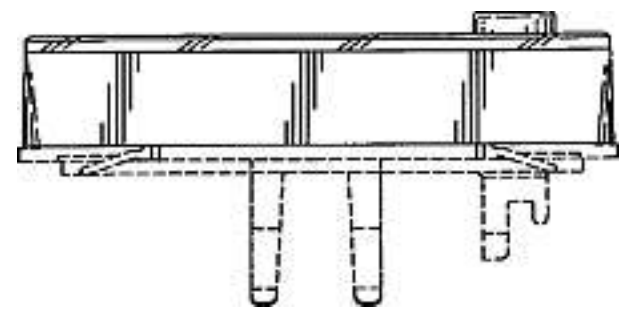
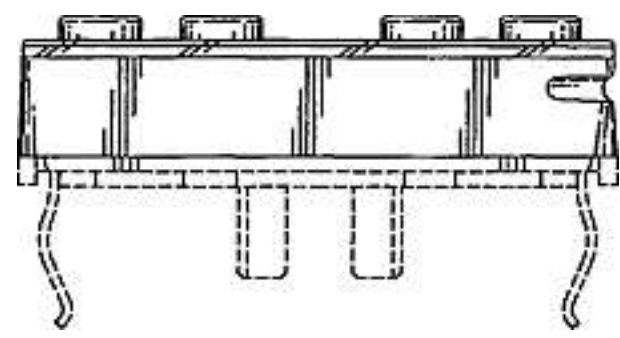
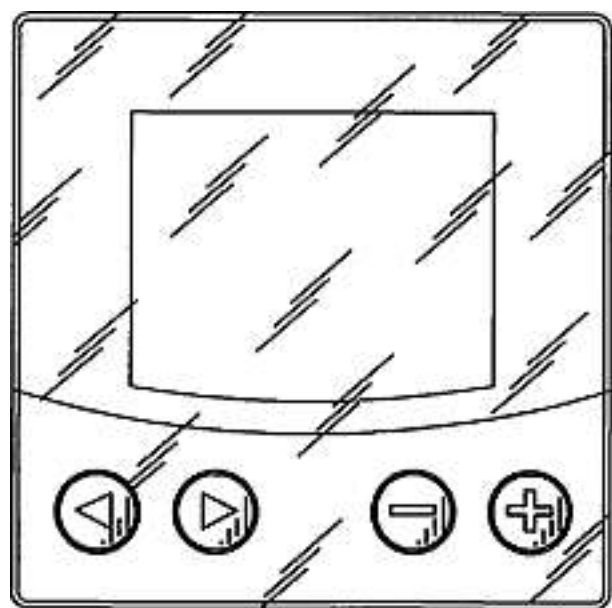
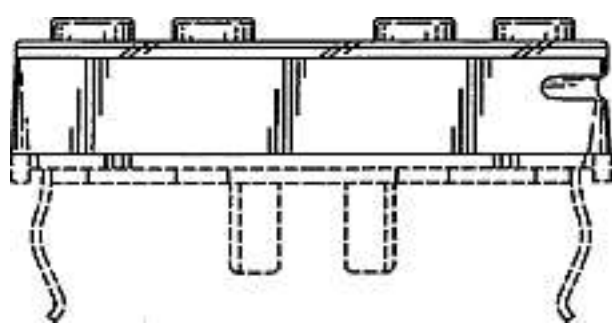
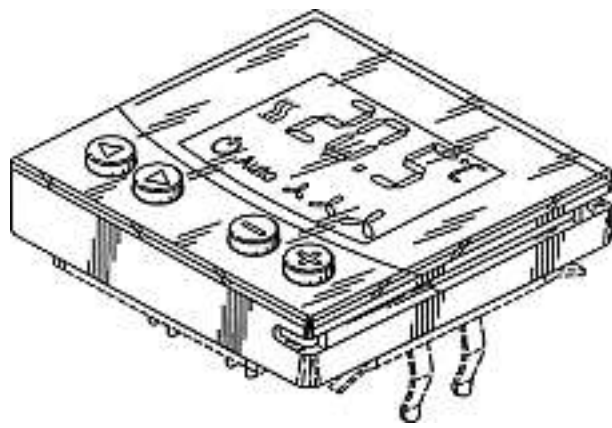

3

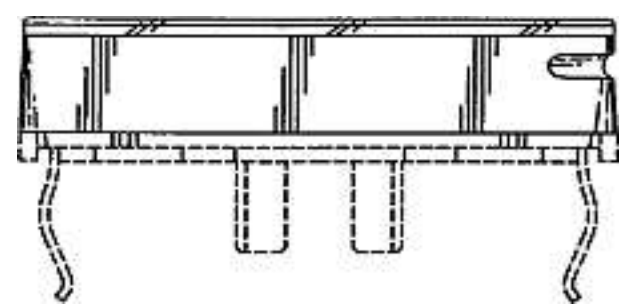

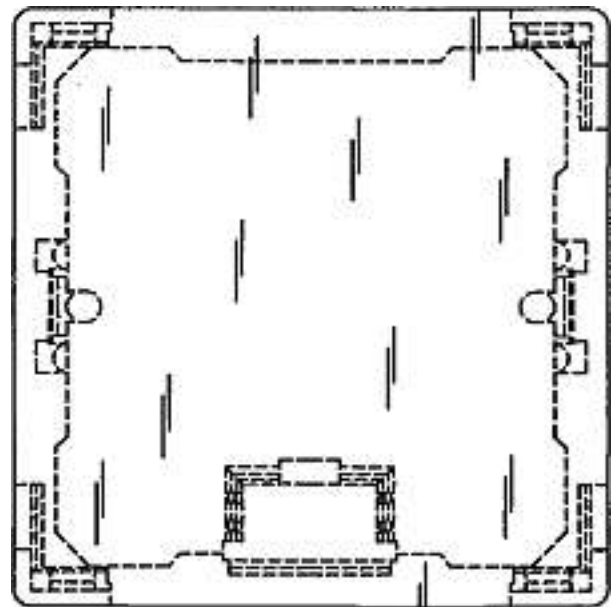
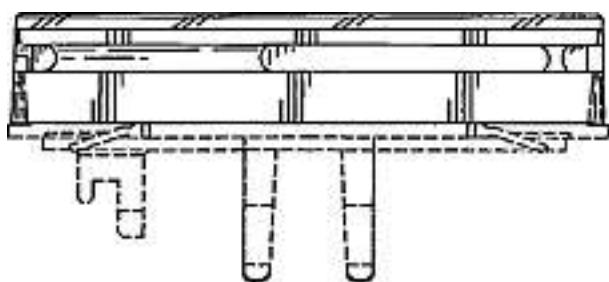
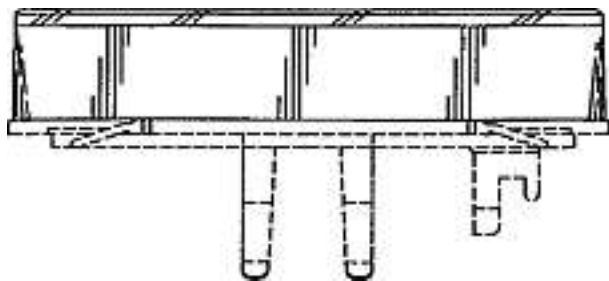
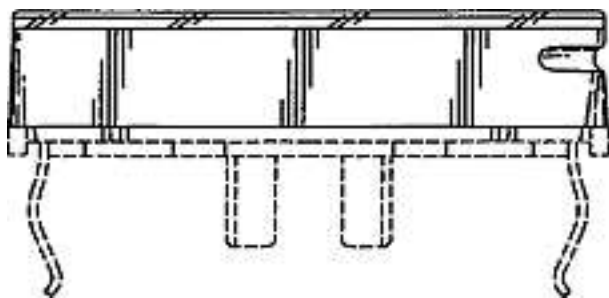
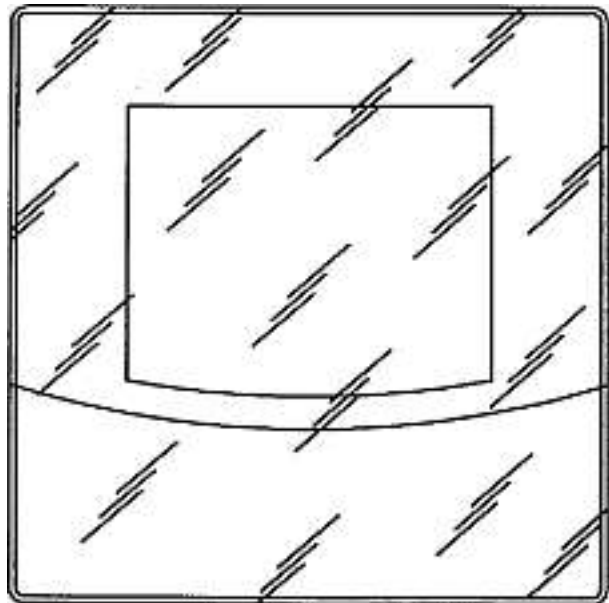
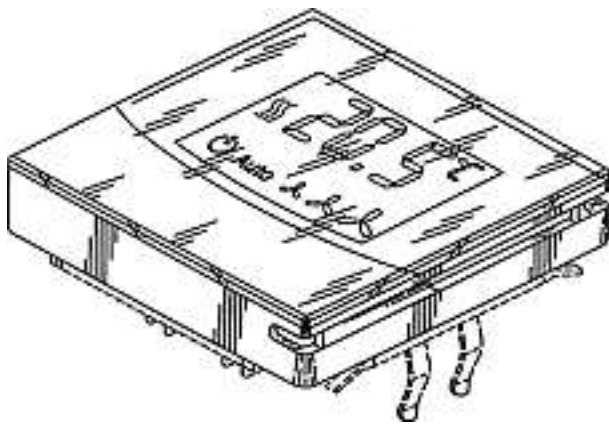

4

Cl. 10-07 131 717 21.03.2005
 1 design – lunette de montre
 Déposant: ROLEX SA, rue François-Dussaud 3-5-7,
 1211 Genève 26
 Designer: Maria Cristina Calvani, Cognoy
 Mandataire: Bugnion S.A., 1211 Genève 12 Champel





No 1

Cl. 10-07 **131 718** 30.03.2005
 2 design – boîte de montre, montre
 Déposant: La Casa Vhernier S.r.l., Via Cunietti 10,
 Valenza (AL), IT
 Designer: André Piot, Milano
 Mandataire: Griffes Consulting S.A., 1206 Genève



MO-112308-9-CH/1



MO-112308-9-CH/2

Cl. 10-07 **131 719** 31.03.2005
 1 Design – Uhrengehäuse
 Hinterleger: Invicta Watch Company of America, Inc.,
 2227 North Federal Highway, Hollywood/FL, US
 Designer: Eyal Lalo, Hallandale
 Vertreter: Zimmerli, Wagner & Partner AG, 8001 Zürich

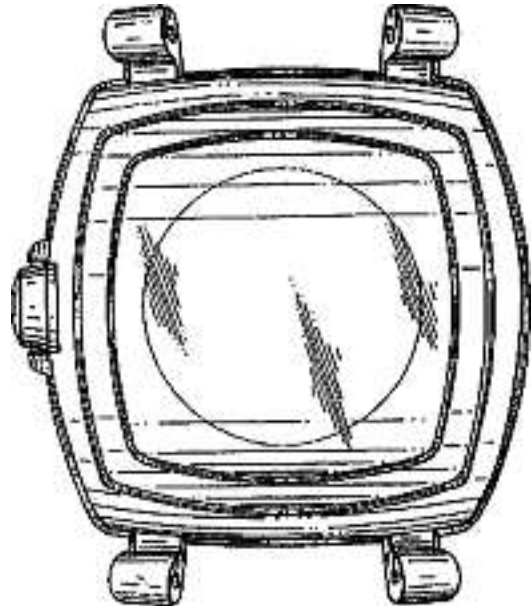
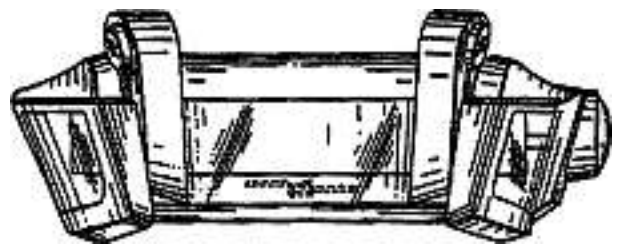
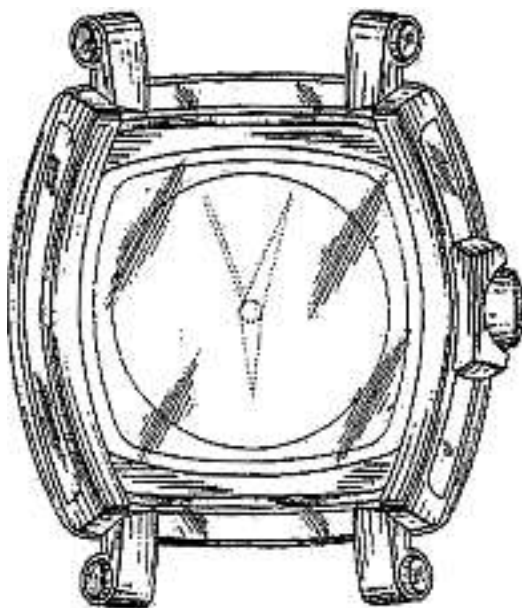
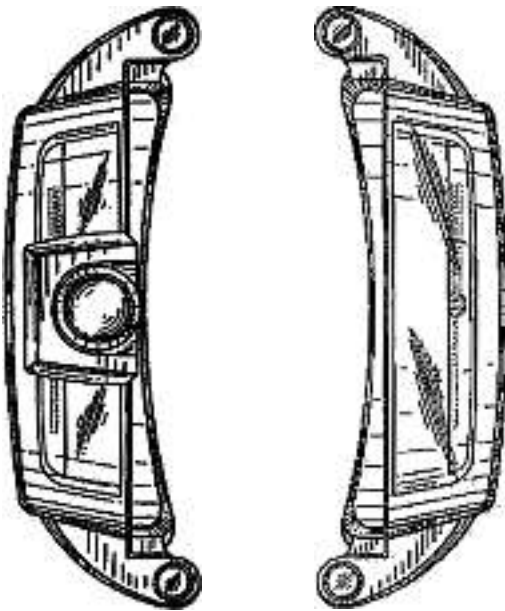
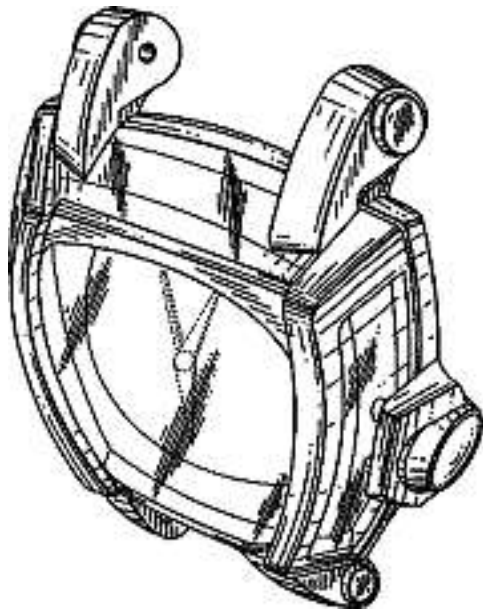

1

Cl. 10-07 **131 720** 31.03.2005
 1 design – boîtier de montre
 Déposant: Léonard S.A., Route de Chêne 41A, 1208 Genève
 Designer: Ricardo Guadalupe, Eclépens
 Mandataire: Griffes Consulting S.A., 1206 Genève

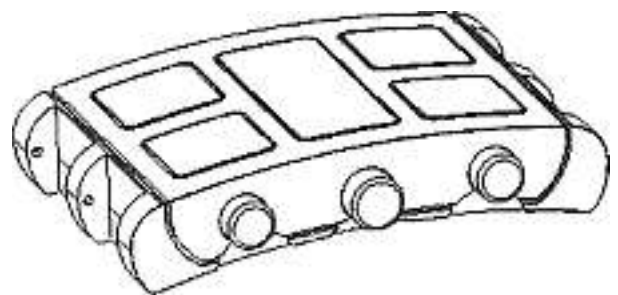
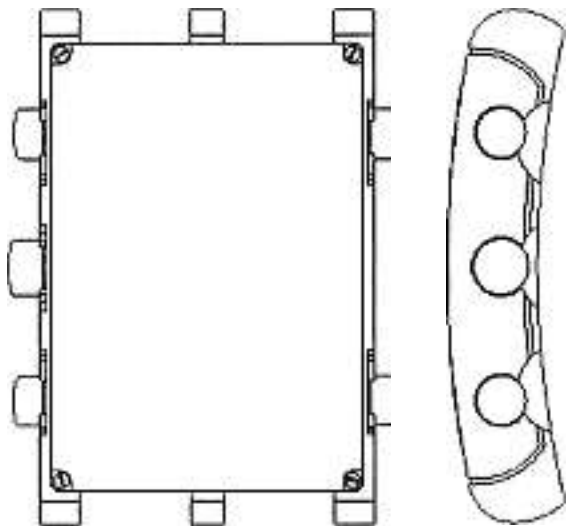

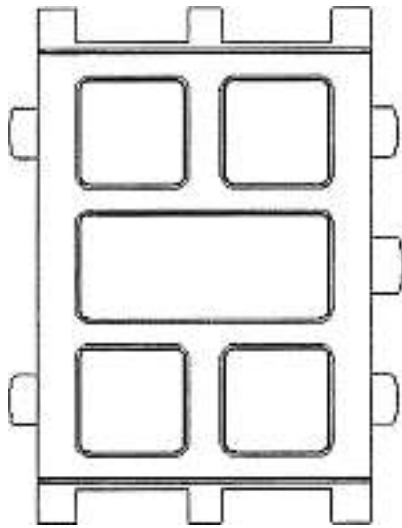

MO-24509-CH

Cl. 10-07 131 721 08.04.2005
6 Design – Uhren
Hinterleger: H. Stern Comércio e Indústria S.A., Rua Visconde de Pirajá, 490, Ipanema, BR
Designer: Adriana de Francisco Miotto, São Paulo
Vertreter: Riederer Hasler & Partner Patentanwälte AG, 7310 Bad Ragaz
Priorität: EM, 28.01.2005

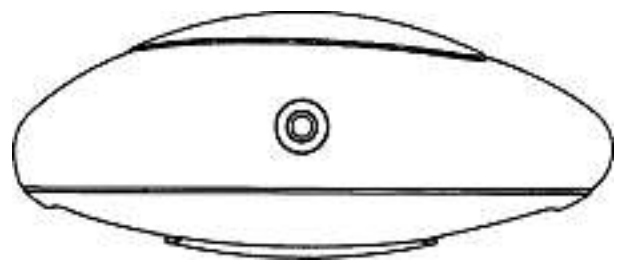
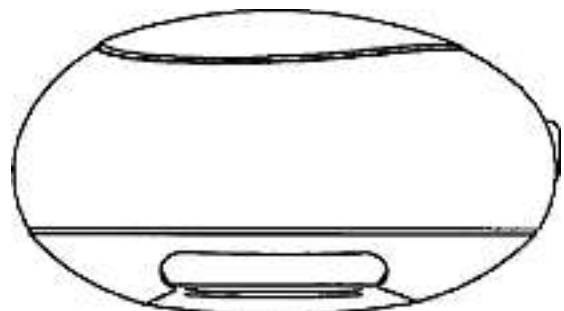
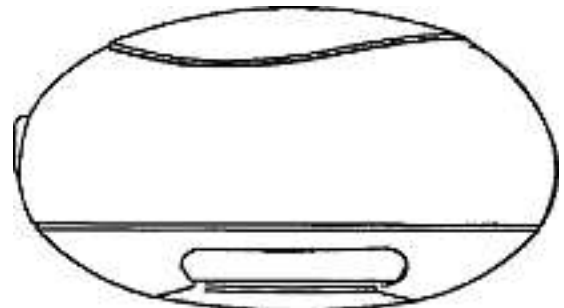
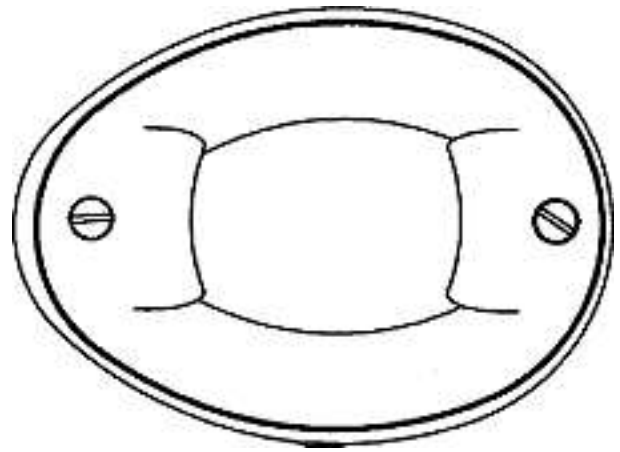

1

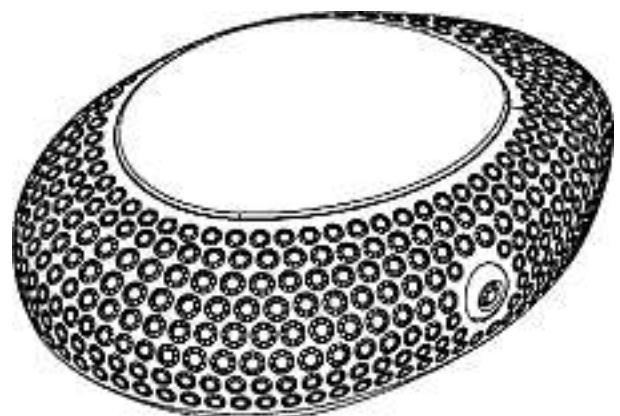
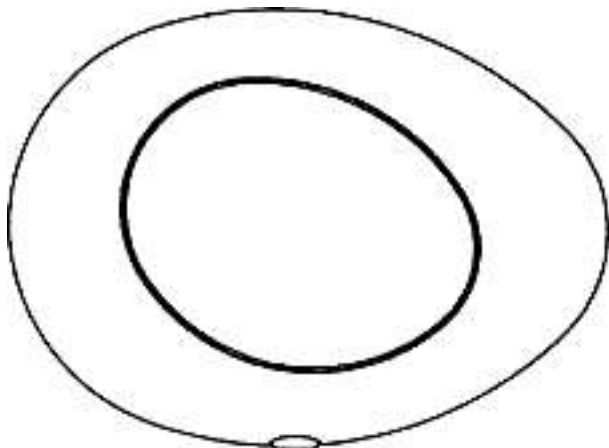
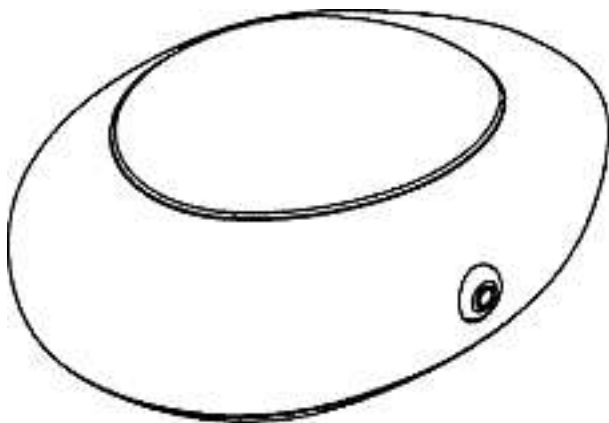

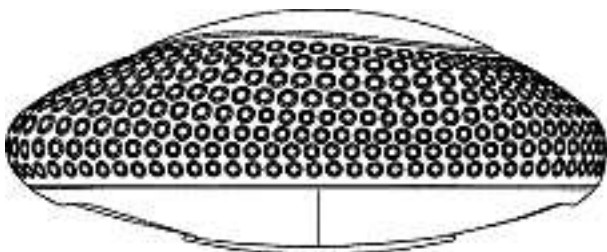
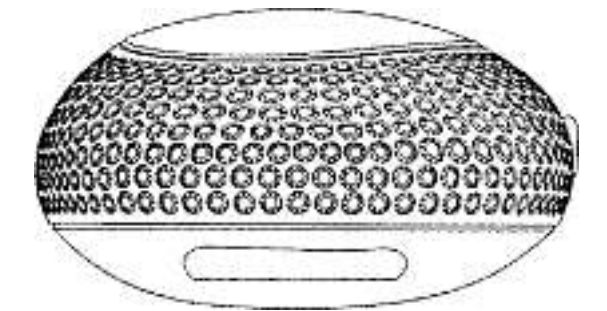
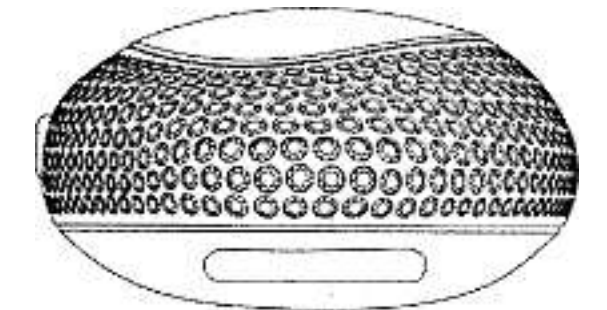
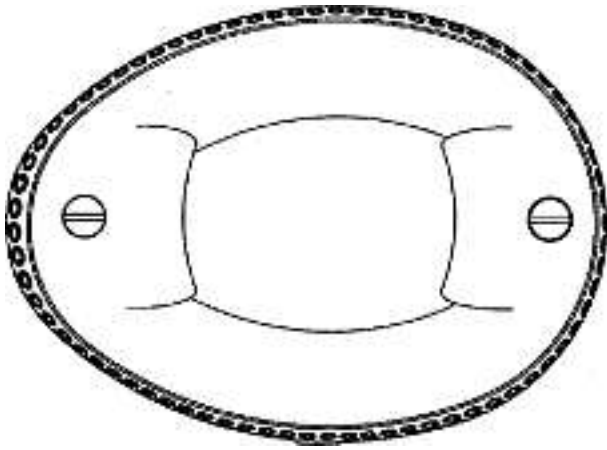
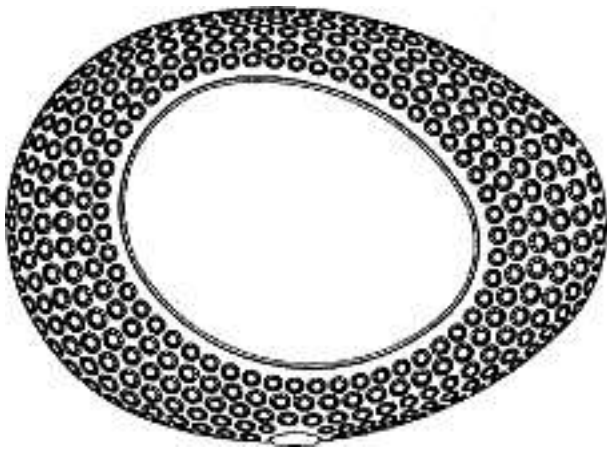

2

3

4

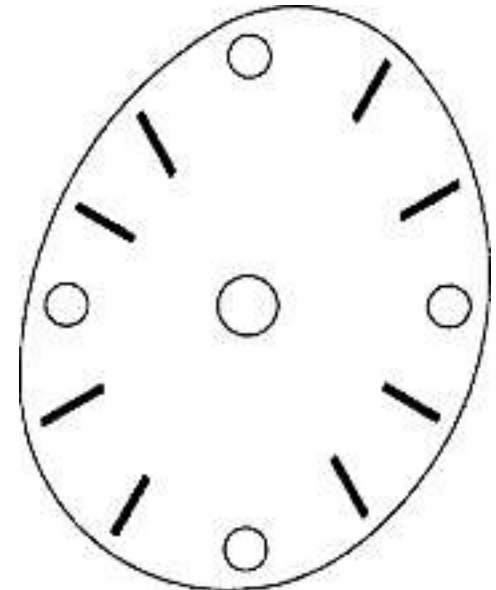
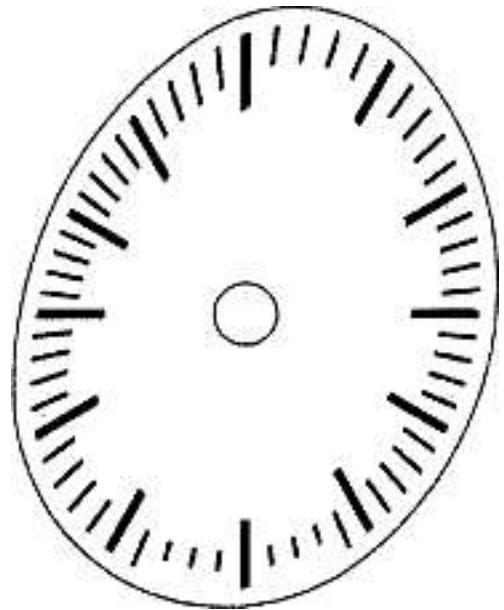
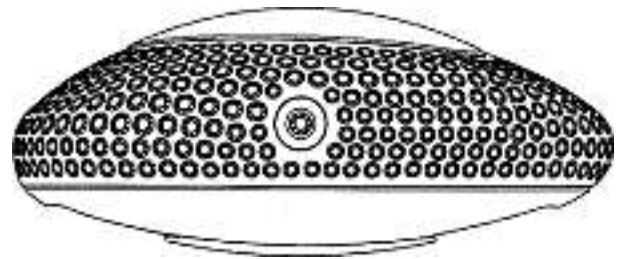

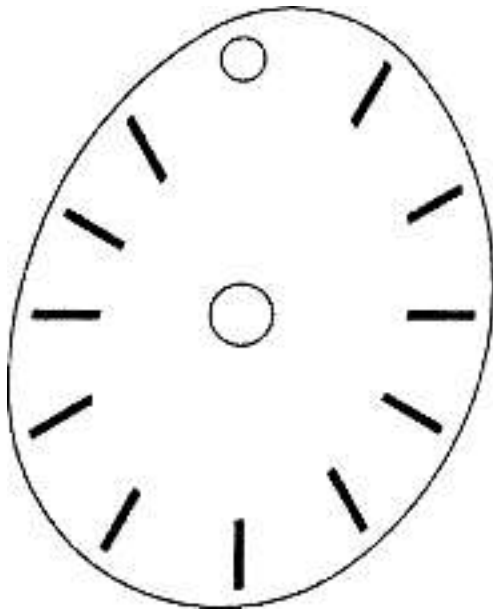

5

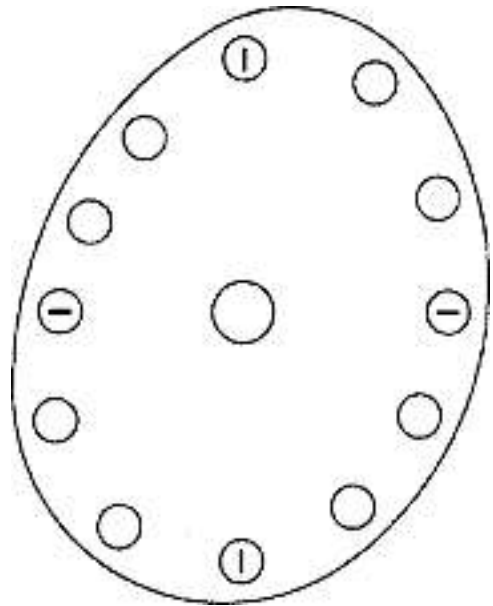

6

Cl. 11-01 131 723 01.04.2005
 1 design – boucle d'oreille
 Déposant: La Tête dans les Etoiles SA, 60 route de Malagnou,
 1208 Genève
 Designer: Christian Goecking, Rolle
 Mandataire: Griffes Consulting S.A., 1206 Genève

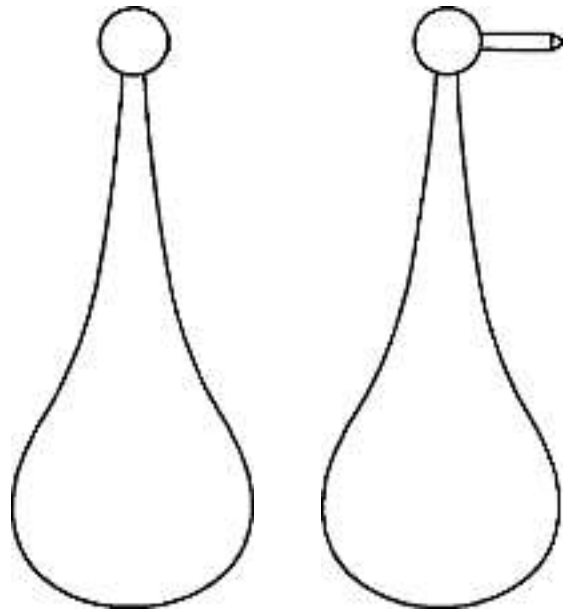
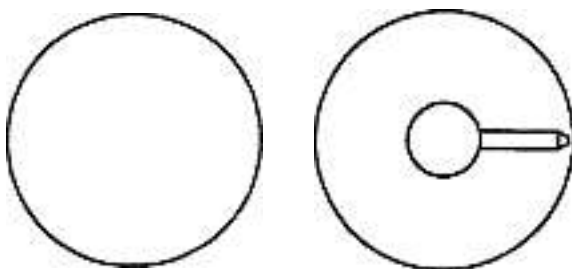

MO-126502-CH

Cl. 11-01 131 724 07.04.2005
 31 Design – Schmuckstücke
 Hinterleger: Meister + Co AG, Hauptstrasse 66, 8832 Wollerau
 Designer: Silvio Daldini, Kilchberg ZH; Thomas Geiser,
 Wollerau; Dieter Flehmer, Unteriberg; Marcus Siessegger,
 Wald

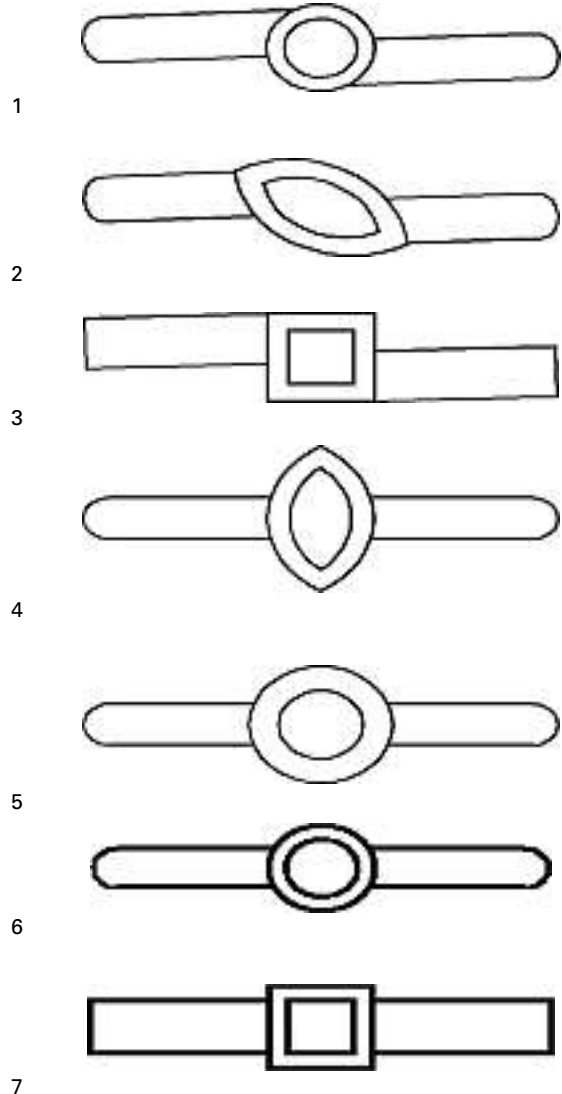

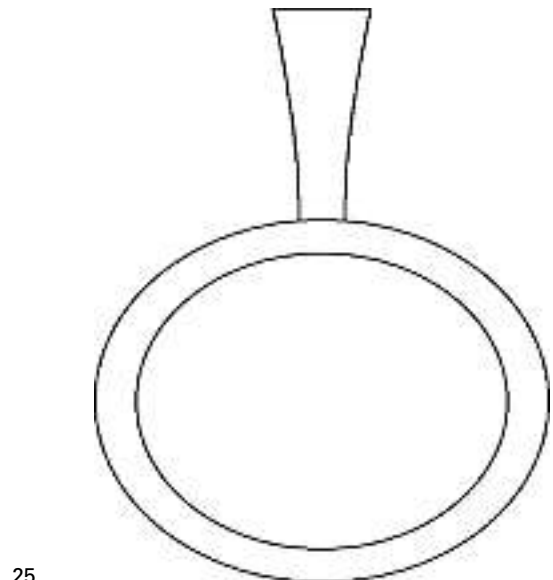
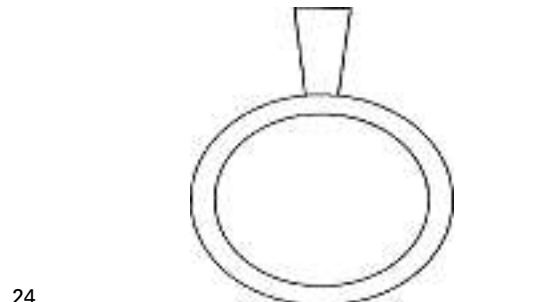
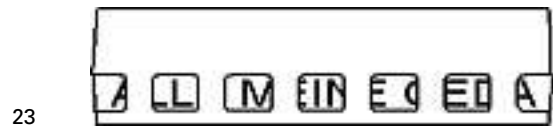
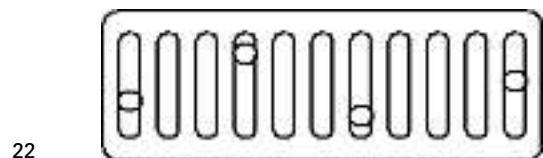
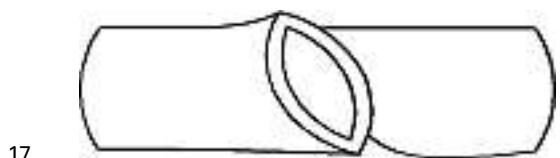
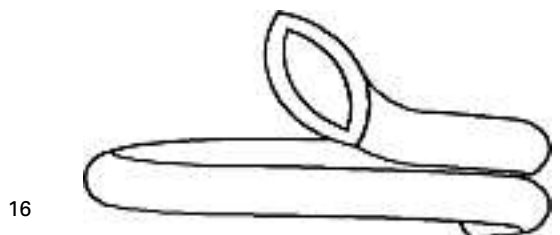
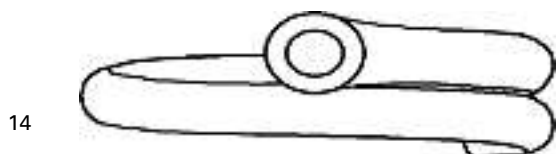
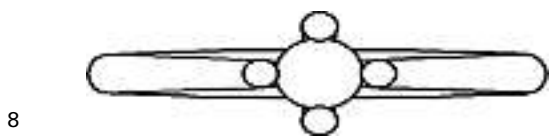

17

25

26

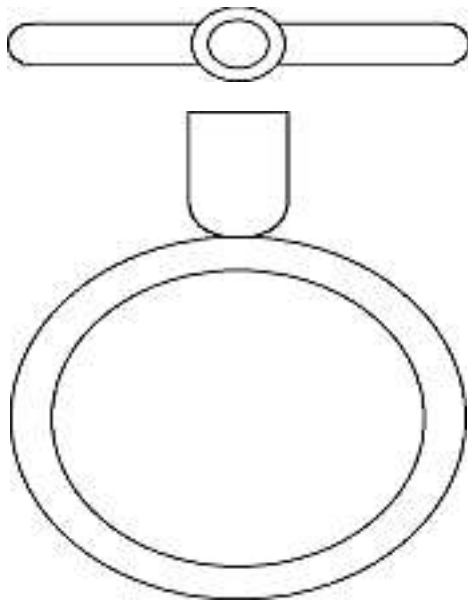

27

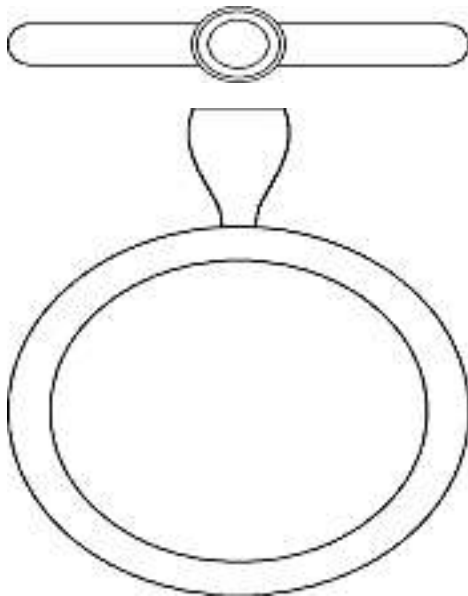

28

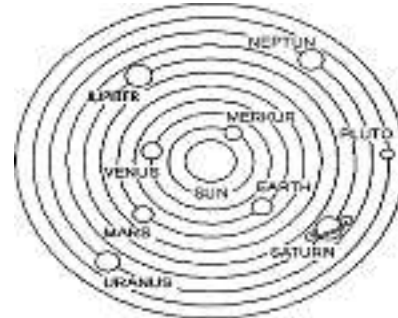
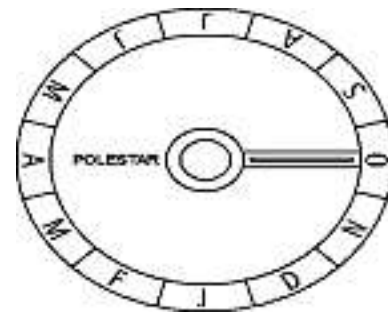
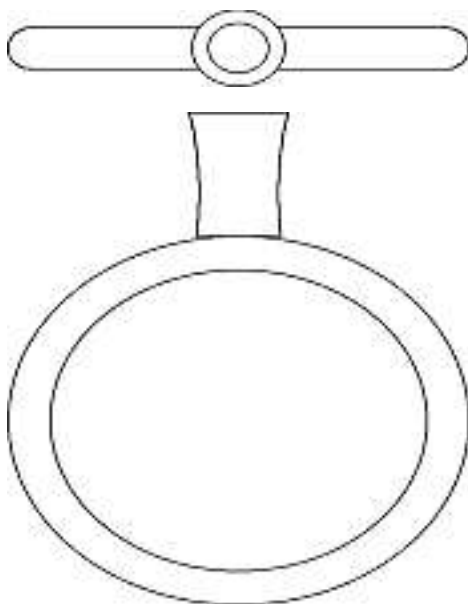

29

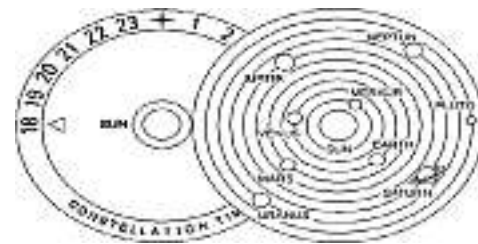
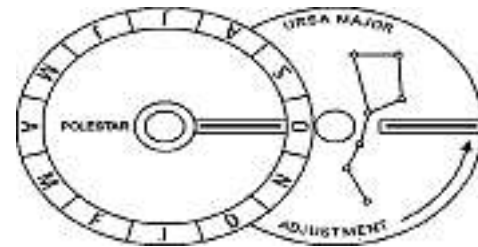

30

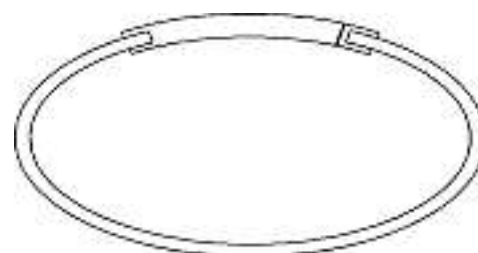
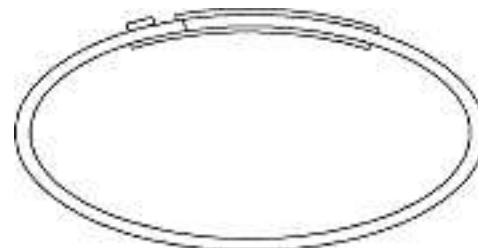

31

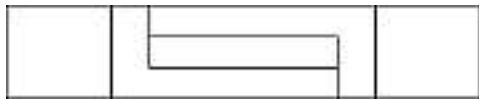

Cl. 12-06 **131 725** 11.04.2005
 4 Design – Teil für Wasserfahrzeuge
 Hinterleger: Peter A. Müller, Obstgartenstrasse 26,
 8136 Gattikon



AT 1



AT 2



AT 3



AT 4

Cl. 12-07 **131 726** 29.03.2005
 1 Design – Ballon
 Hinterleger: Prospective Concepts AG, Flughafenstrasse 41,
 8152 Glattbrugg
 Designer: Andreas Reinhard, Zürich
 Vertreter: Dr. R. C. Salgo + Partner, Patentanwälte AG,
 8636 Wald ZH

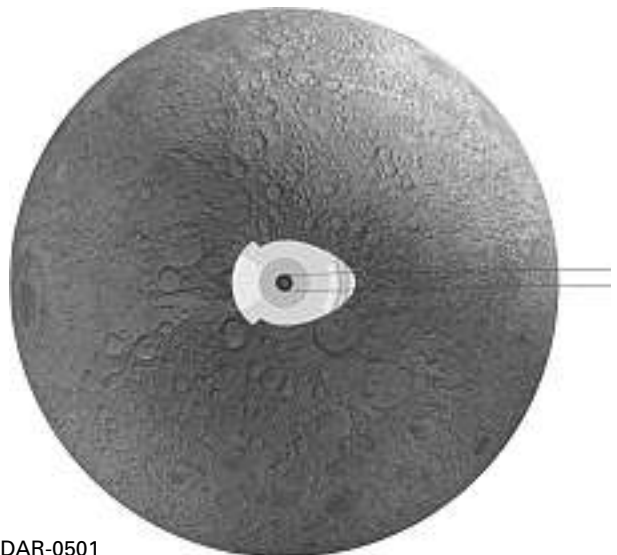

DAR-0501

Cl. 12-12 **131 727** 13.04.2005
 1 Design – Rollstuhl
 Hinterleger: Otto Bock HealthCare GmbH,
 Max-Näder-Strasse 15, 37115 Duderstadt, DE
 Designer: Urs Schoenauer, Arosa
 Vertreter: Braunpat Braun Eder AG, 4054 Basel
 Priorität: EM, 13.10.2004
 1 (siehe Farbteil Heftmitte)

Cl. 12-16 **131 728** 31.03.2005
 2 Design – Fahrzeugmarkierung mit Blende
 Hinterleger: Charles I. Sassoon, 203C West Shore Road,
 Kings Point/NY, US
 Vertreter: Isler & Pedrazzini AG, 8023 Zürich
 Priorität: US, 01.10.2004



M13017/1



M13017/2

Cl. 14-03 **131 729** 24.03.2005
 6 design – boîtiers de réception
 Déposant: British Sky Broadcasting Limited, Grant Way,
 Isleworth, Middx TW7 5QD, GB
 Designer: James Whittaker, Herrenberg; Andrew Wong,
 Herrenberg; Robert Curtis, Herrenberg
 Mandataire: Kirker & Cie S.A., Ingénieurs-Conseils,
 1226 Genève - Thônex
 Priorité: GB, 29.09.2004; EM, 07.02.2005

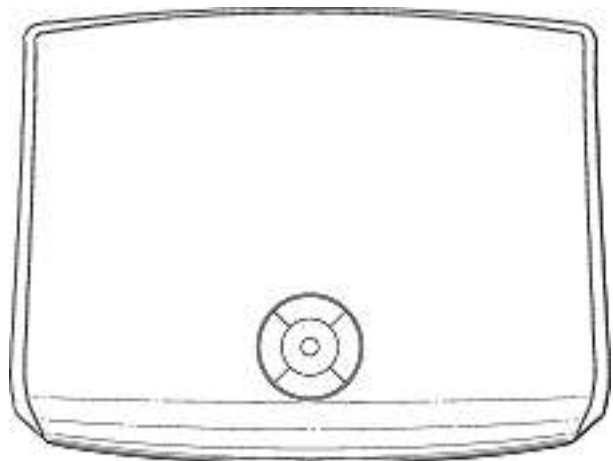
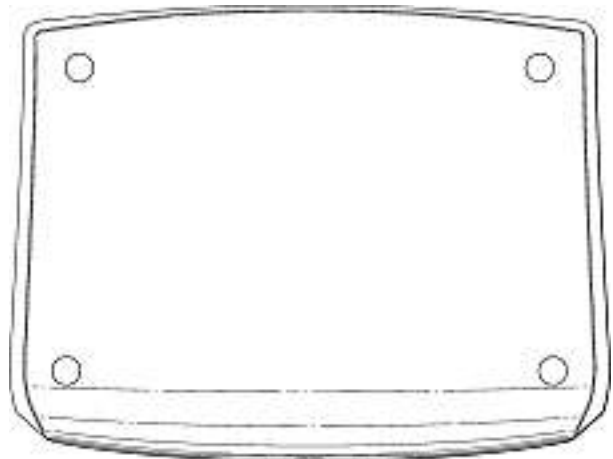

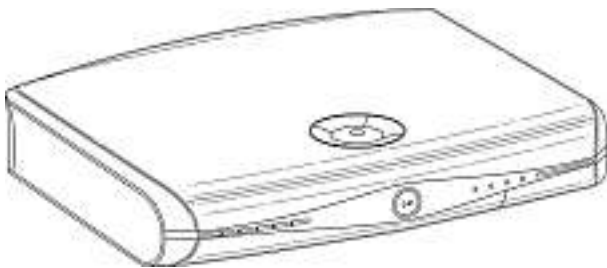
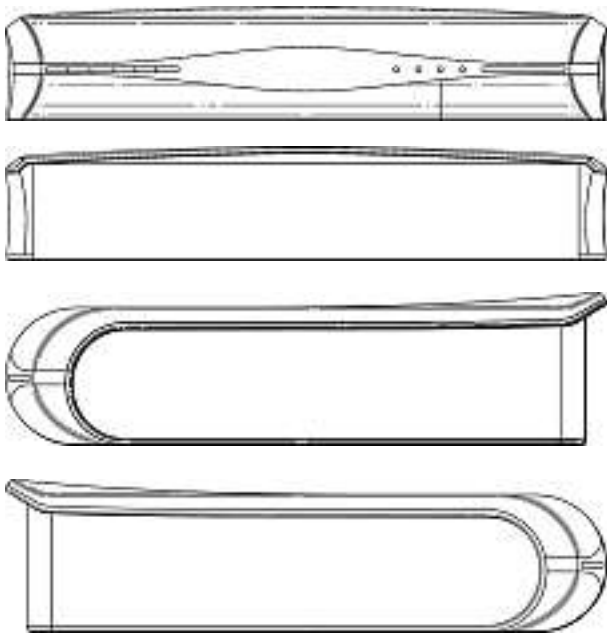

1



2

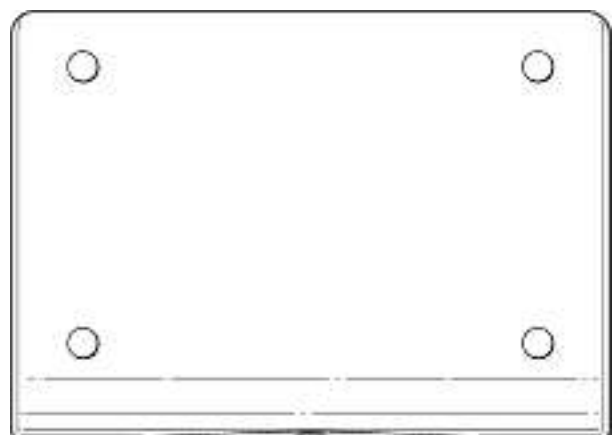
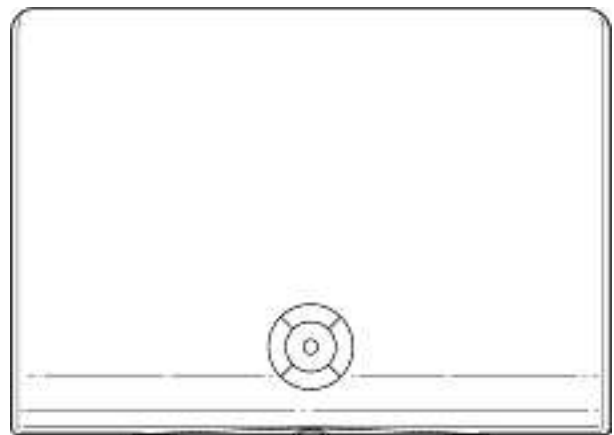

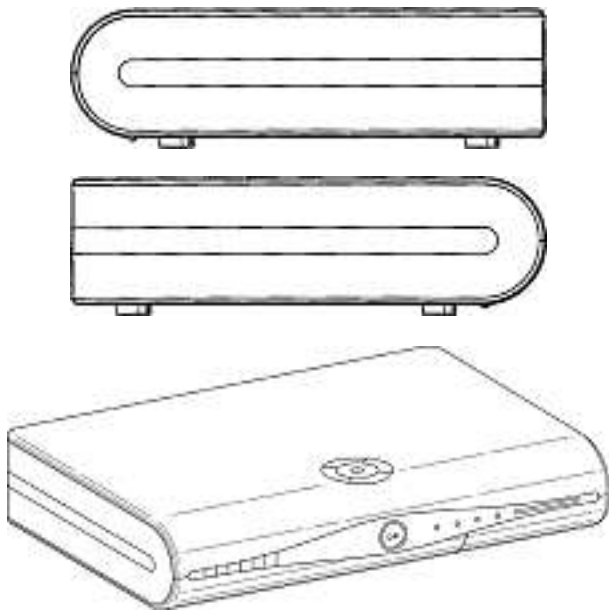

3



4

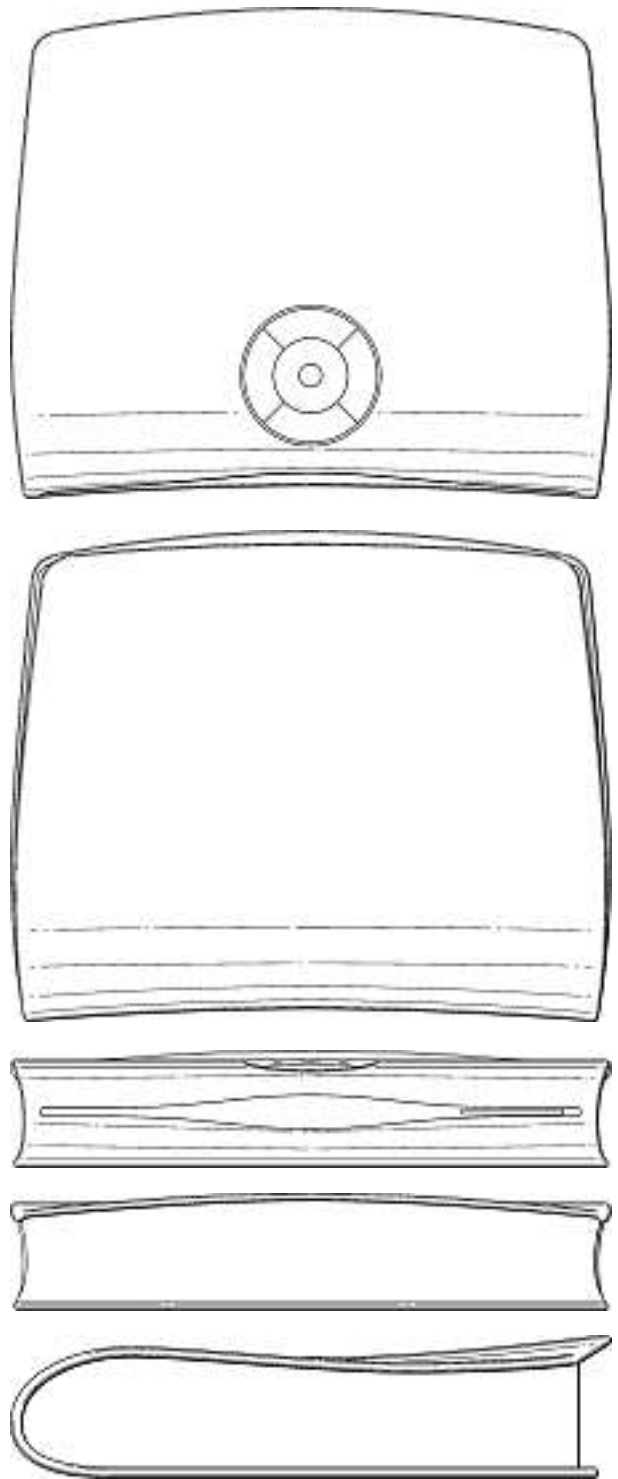

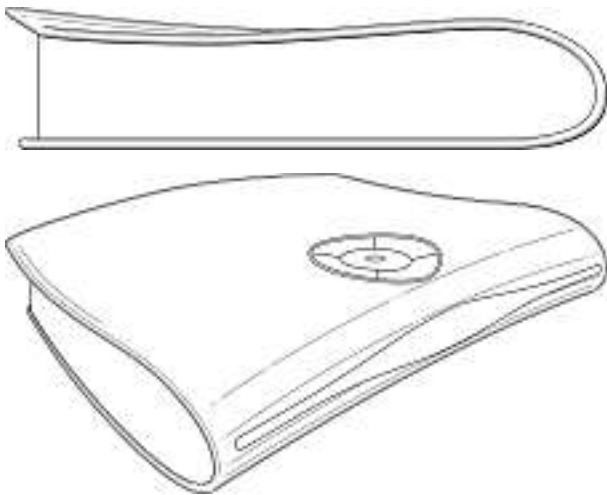

5



6

Cl. 14-03, 14-99 **131 730** 31.03.2005
 2 Design – Handsender und Halterung
 Hinterleger: Griesser Holding AG, Tänikonstrasse 3,
 8355 Aadorf
 Designer: Axel Hamke, Köln; Kurt Zimmerli, Warth
 Vertreter: Hans Rudolf Gachnang, 8501 Frauenfeld

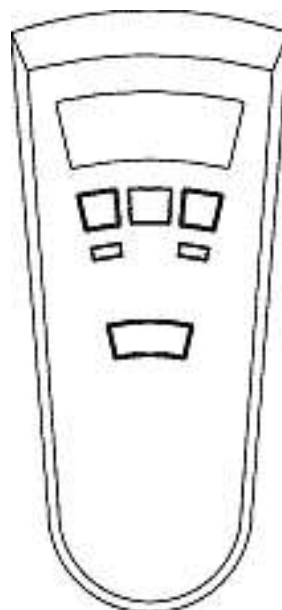
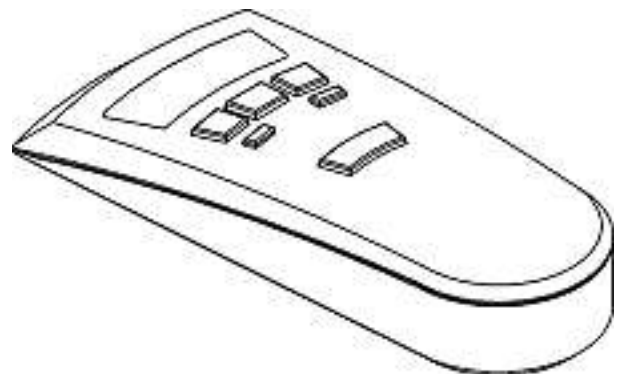

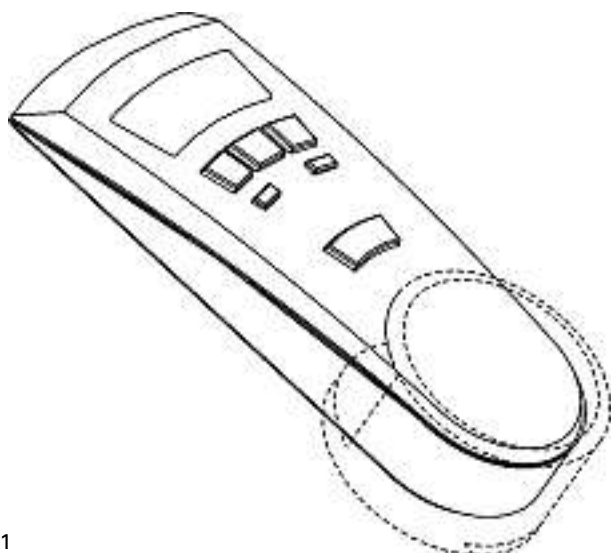

1

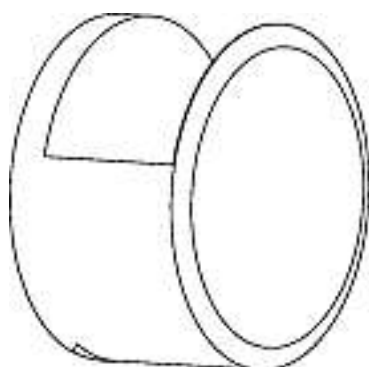

2

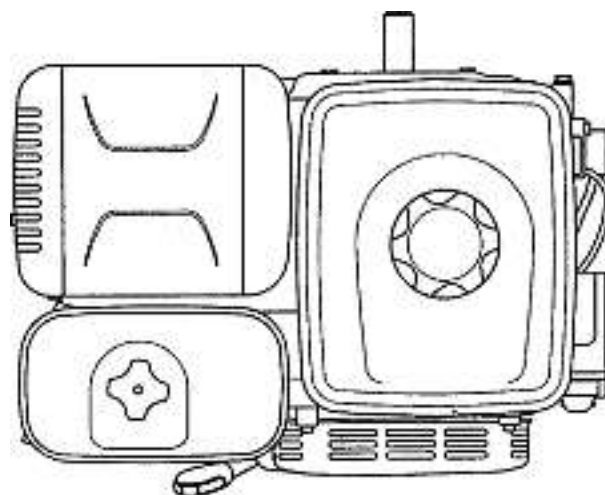
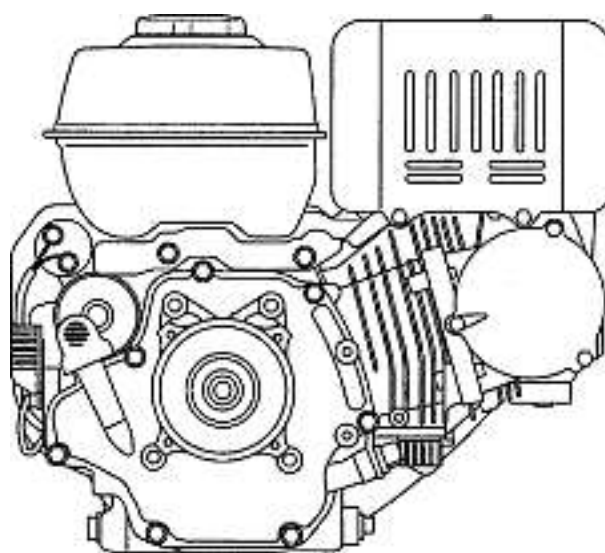

Cl. 15-01 **131 731** 11.04.2005
 3 design – motore a combustione interna e sue parti
 Depositante: Honda Motor Co., Ltd., No. 1-1, 2-chome,
 Minami-aoyama, Minato-ku, Tokyo, JP
 Designer: Joji Maeda, Saitama; Masayuki Osumi, Saitama
 Mandatario: Fiammenghi-Fiammenghi, 6900 Lugano
 Priorità: JP, 15.10.2004

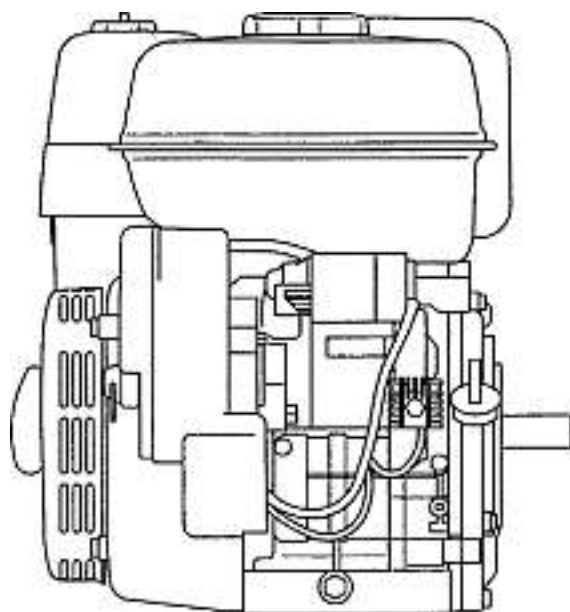
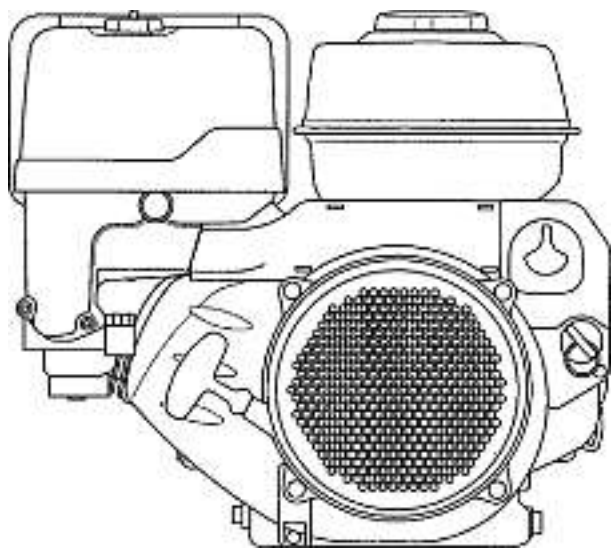

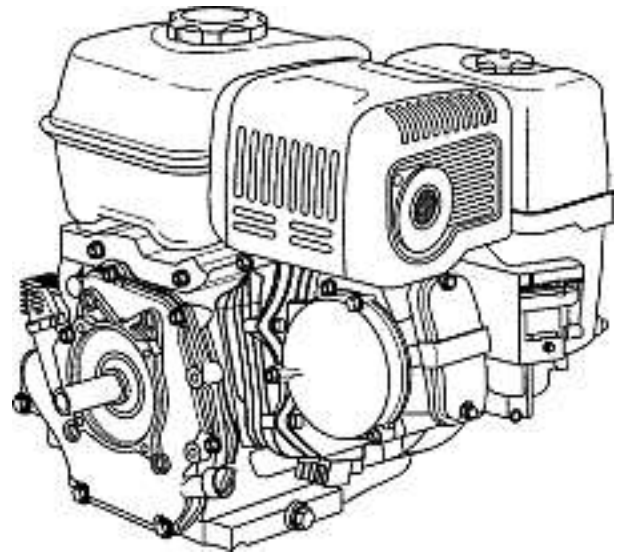
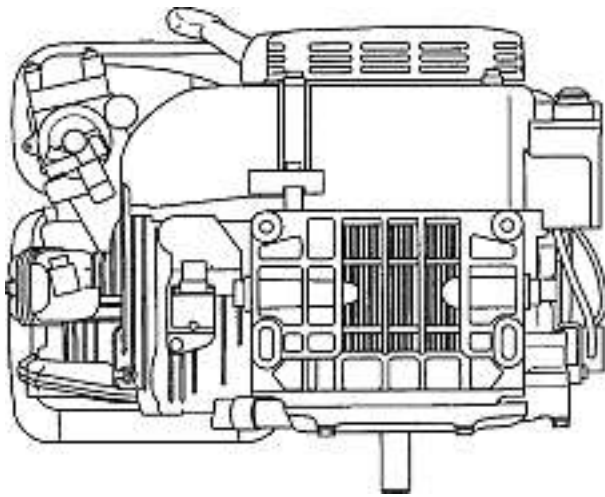

447/1

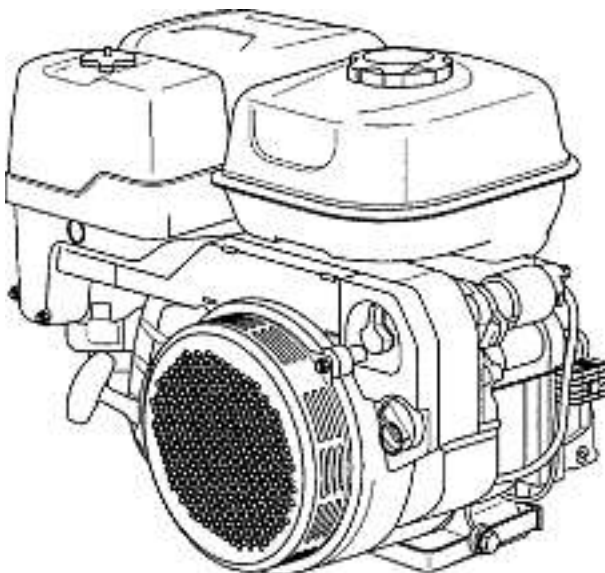
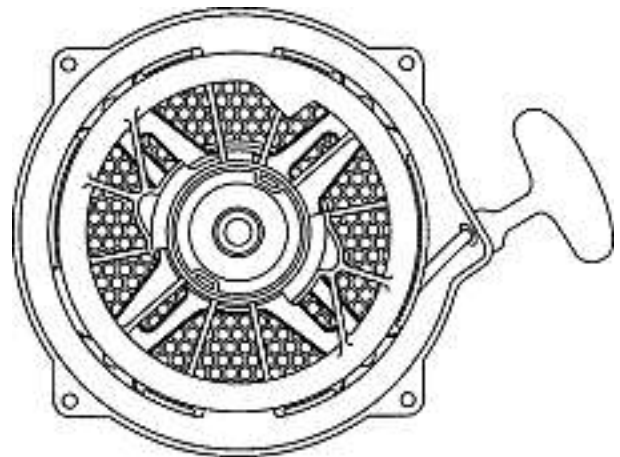
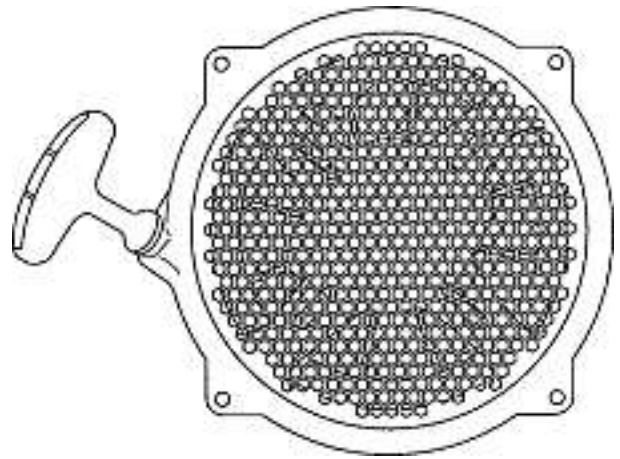
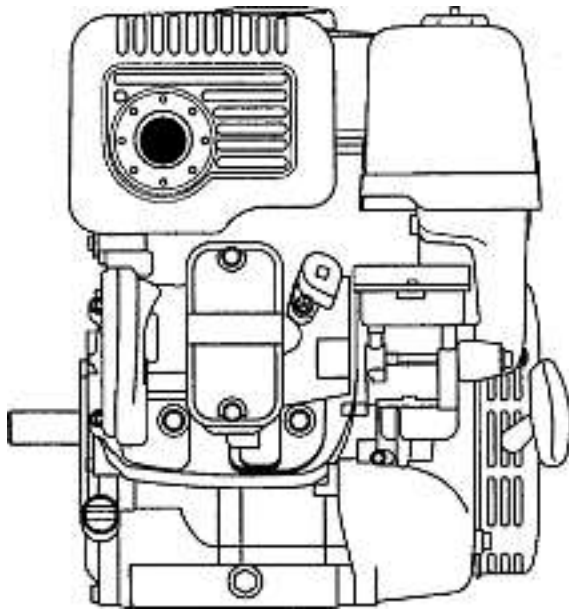

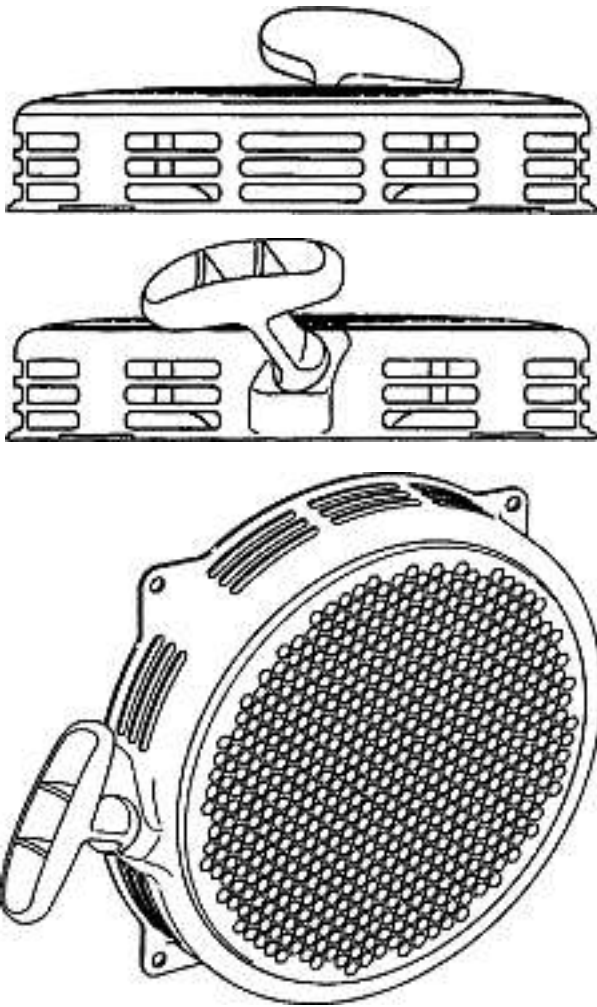

447/2

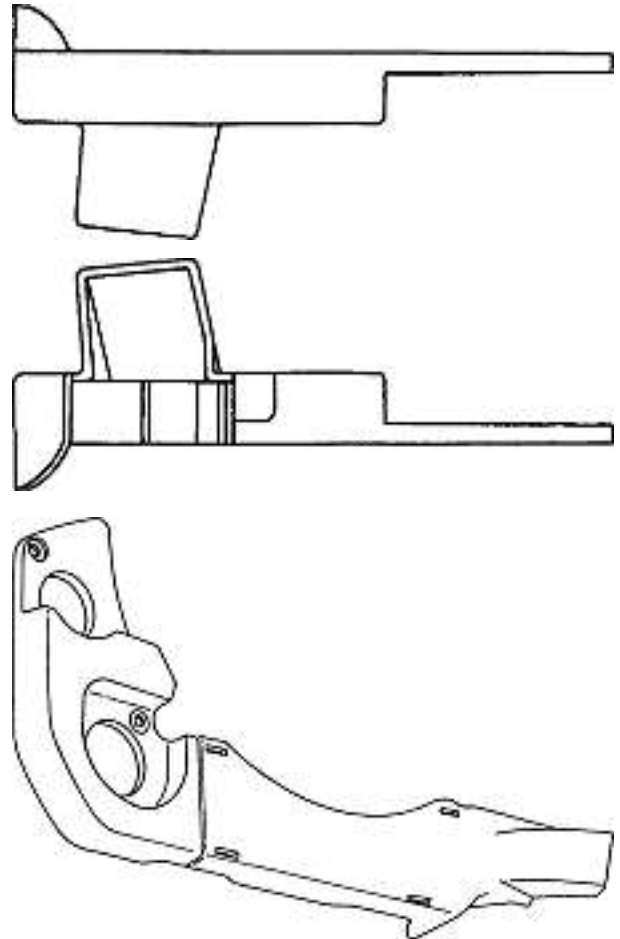
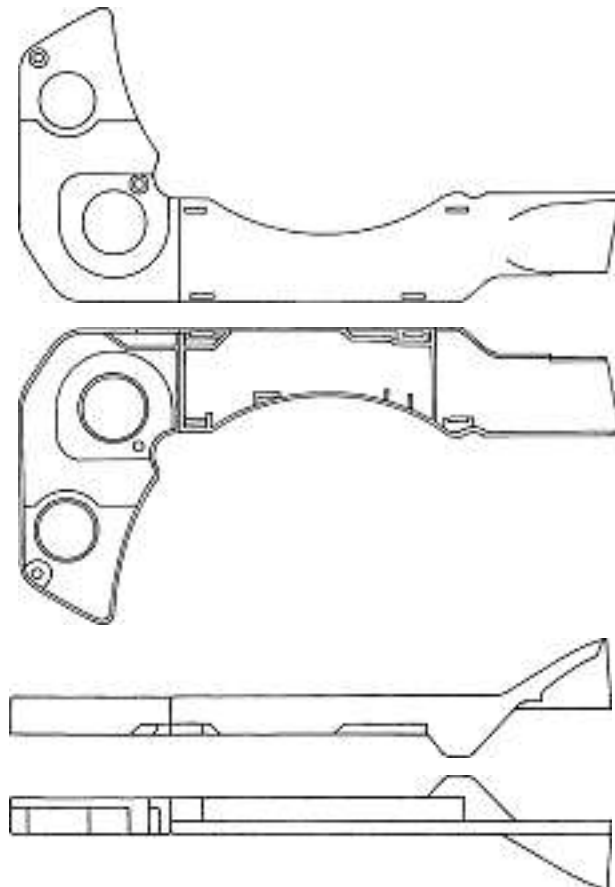

447/3

Cl. 17-03 **131 732** 01.04.2005
 2 Design – Gitarren-Korpusabschnitt
 Hinterleger: Triff AG, Delfterstrasse 41, 5004 Aarau
 Designer: Mark Erismann, Aarau



B300.1

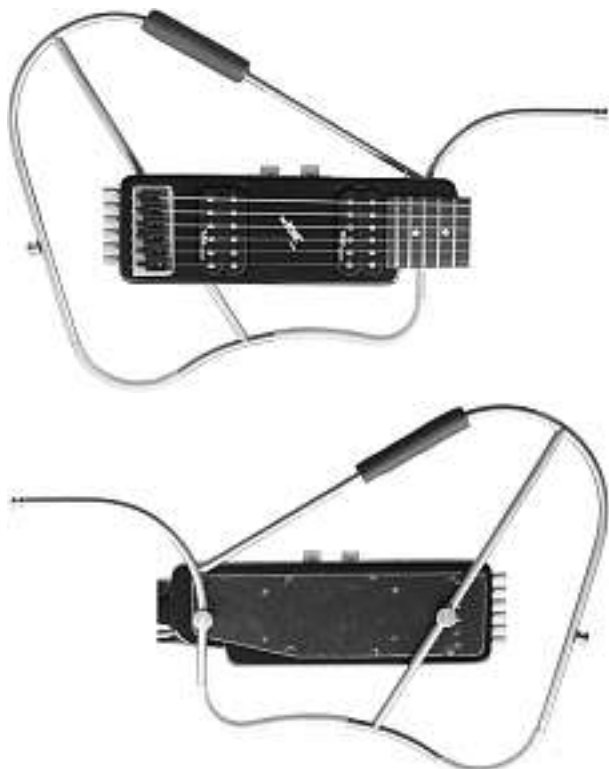

B300.2

 Cl. 19-08 **131 733** 18.01.2005

15 Design – Figuren

 Hinterleger: Mars, Incorporated, A Delaware Corporation,
 6885 Elm Street, McLean/VA, US

Designer: Jonathan Flack, Douglas

Vertreter: A.W. Metz & Co. AG, 8024 Zürich

Priorität: EM, 19.07.2004

- 1 (siehe Farbteil Heftmitte)
- 2 (siehe Farbteil Heftmitte)
- 3 (siehe Farbteil Heftmitte)
- 4 (siehe Farbteil Heftmitte)
- 5 (siehe Farbteil Heftmitte)
- 6 (siehe Farbteil Heftmitte)
- 7 (siehe Farbteil Heftmitte)
- 8 (siehe Farbteil Heftmitte)
- 9 (siehe Farbteil Heftmitte)
- 10 (siehe Farbteil Heftmitte)
- 11 (siehe Farbteil Heftmitte)
- 12 (siehe Farbteil Heftmitte)
- 13 (siehe Farbteil Heftmitte)
- 14 (siehe Farbteil Heftmitte)
- 15 (siehe Farbteil Heftmitte)

 Cl. 21-01 **131 736** 30.04.2005

1 Design – Spielbrett

Hinterleger: Uwe Löhr, Waldeggstrasse 2, 9602 Bazenheid

 Vertreter: Abatron-Patentbüro AG, 8048 Zürich
 1290 I 311/C (siehe Farbteil Heftmitte)

 Cl. 23-02 **131 737** 13.04.2005

1 Design – Einschraubrossette

 Hinterleger: Neoperl GmbH, Klostersrundsstrasse 11,
 79379 Müllheim, DE

Designer: Heinz Büttgen, Bad Krozingen

Vertreter: Hans Rudolf Gachnang, 8501 Frauenfeld

Priorität: EM, 23.02.2005



1

 Cl. 25-01 **131 738** 06.04.2005

4 Design – Rindenmulch

Hinterleger: Bernd Mende, Hinter der Bahn 9b, Weiden, DE

Vertreter: PA Aldo Römpler, 9410 Heiden

1 (siehe Farbteil Heftmitte)

2 (siehe Farbteil Heftmitte)

3 (siehe Farbteil Heftmitte)

4 (siehe Farbteil Heftmitte)

 Cl. 25-03 **131 739** 29.03.2005

1 Design – Verankerungs-Station für Fesselballon

 Hinterleger: Prospective Concepts AG, Flughafenstrasse 41,
 8152 Glattbrugg

Designer: Andreas Reinhard, Zürich

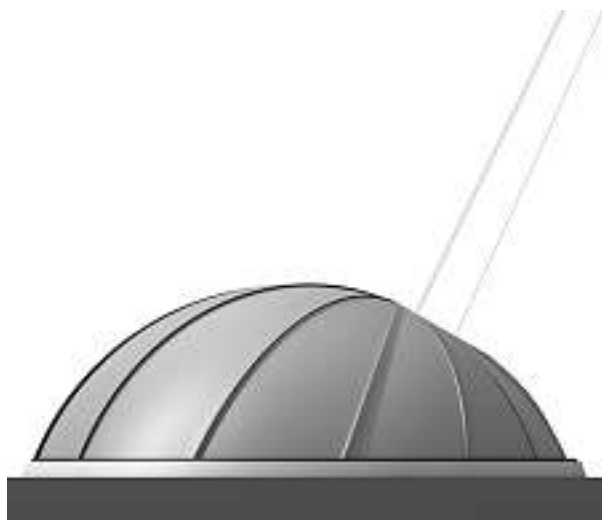
 Vertreter: Dr. R. C. Salgo + Partner, Patentanwälte AG,
 8636 Wald ZH

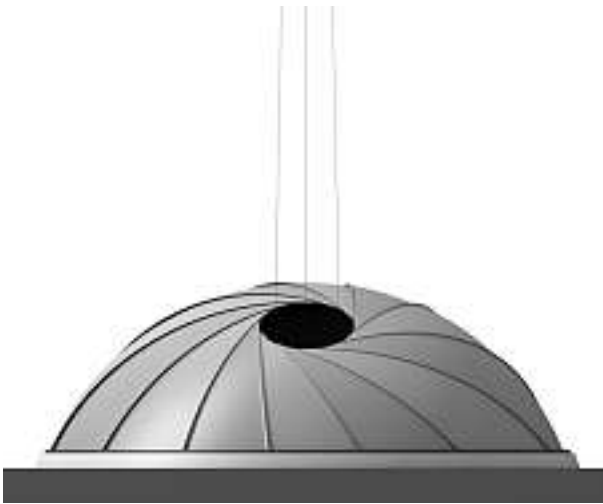

DAR-0502

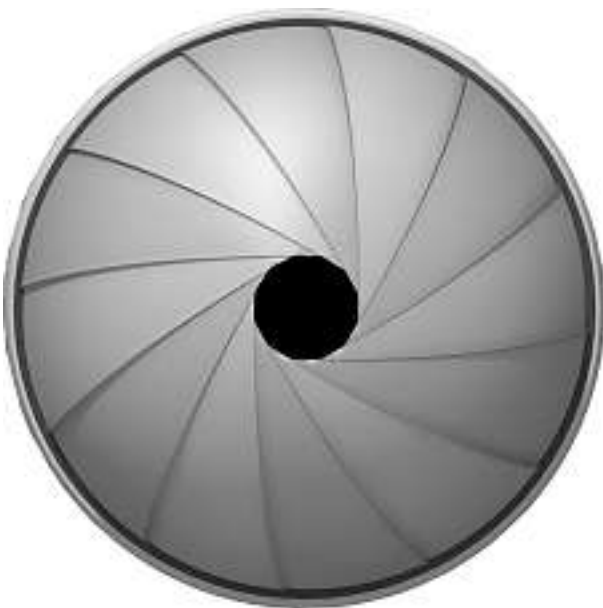
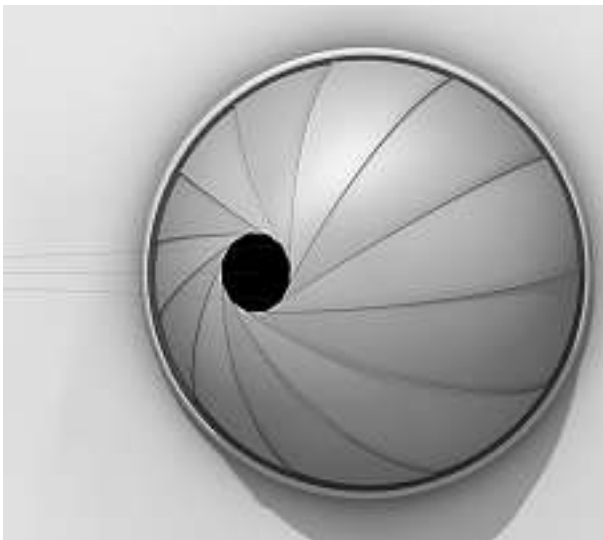

Cl. 26-05 **131 740** 04.04.2005
2 Design – Beleuchtungsapparate
Hinterleger: iGUZZINI ILLUMINAZIONE S.p.A., Via Mariano
Guzzini 37, Recanati, Macerata, IT
Designer: Giannunzio Guzzini, Recanati
Vertreter: Bovard AG, 3000 Bern 25
Priorität: EM, 06.10.2004

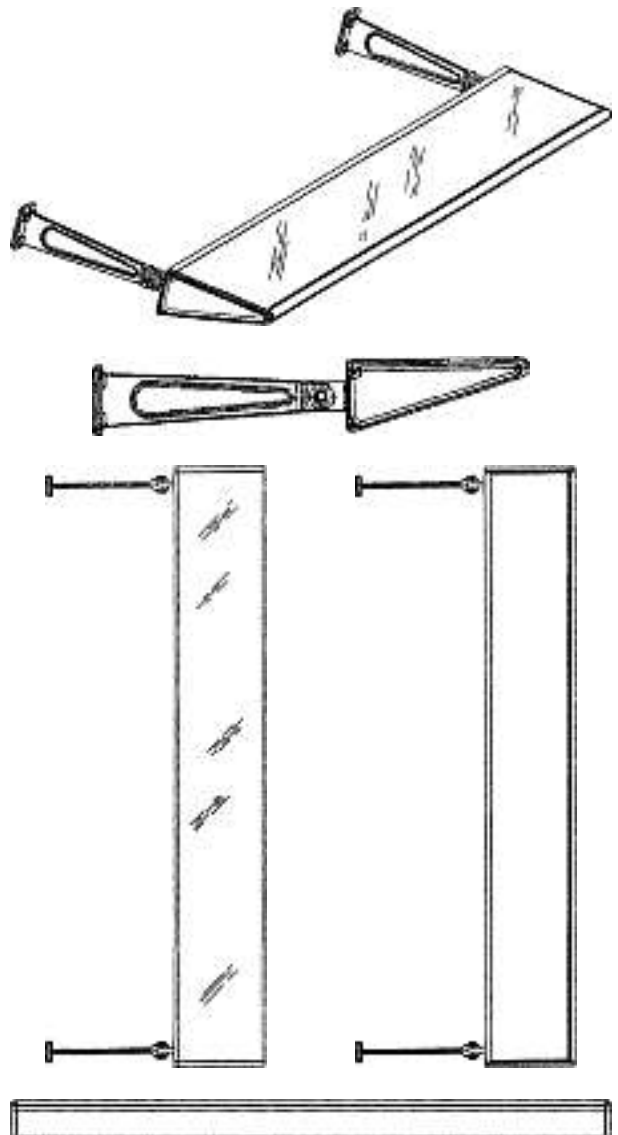

300475 (1)

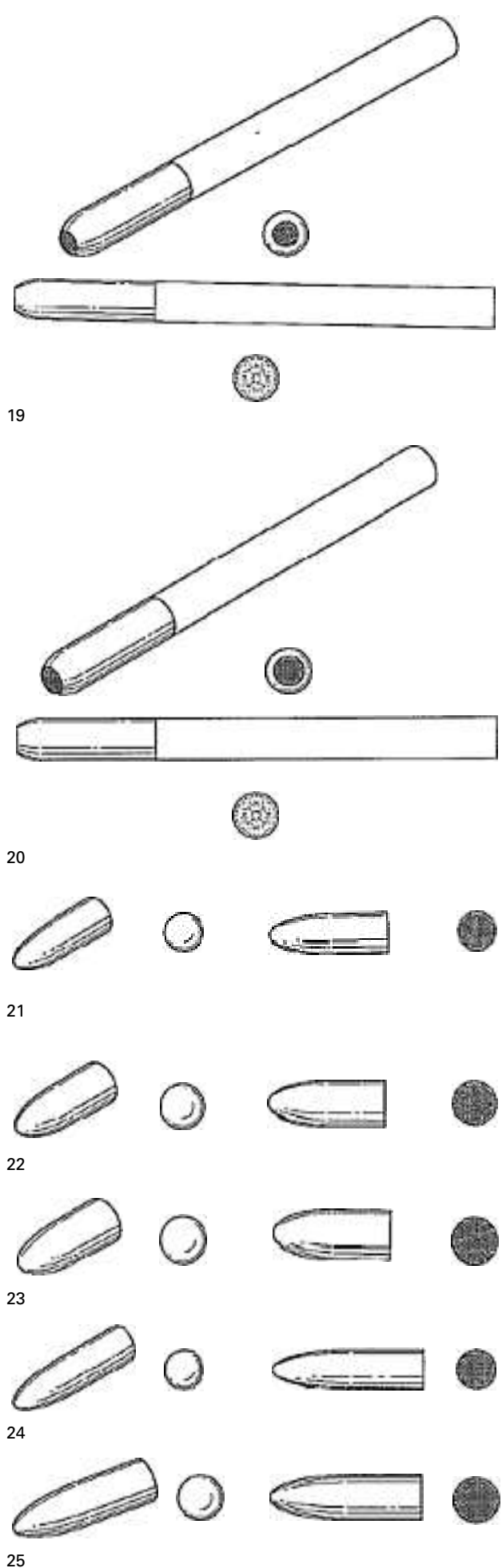
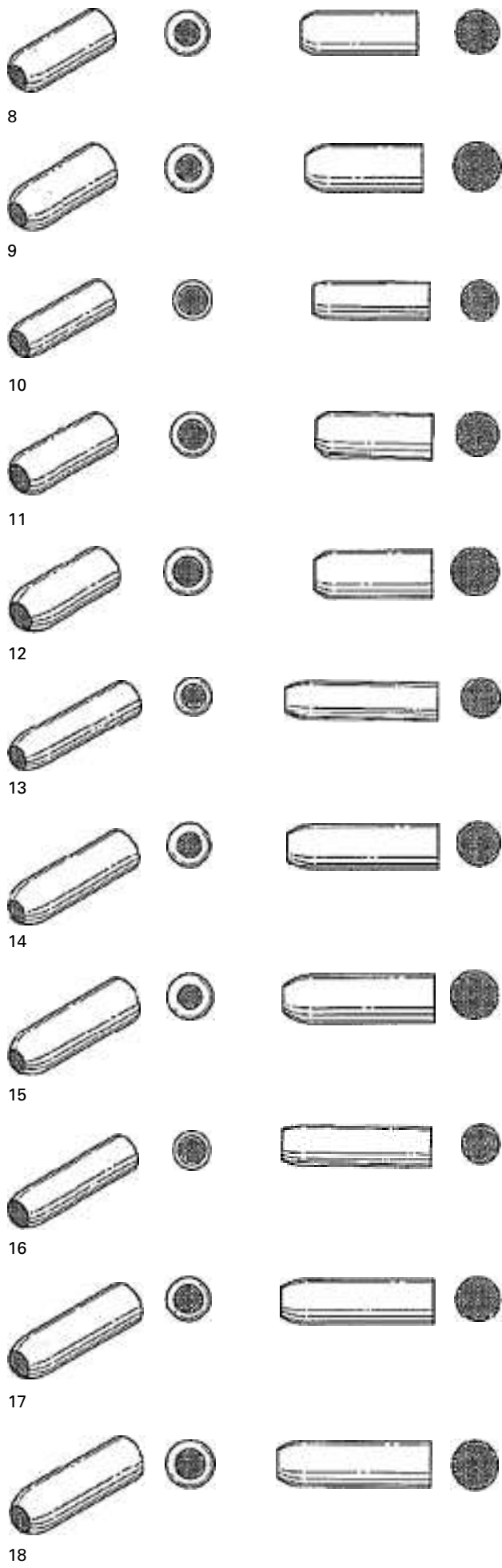

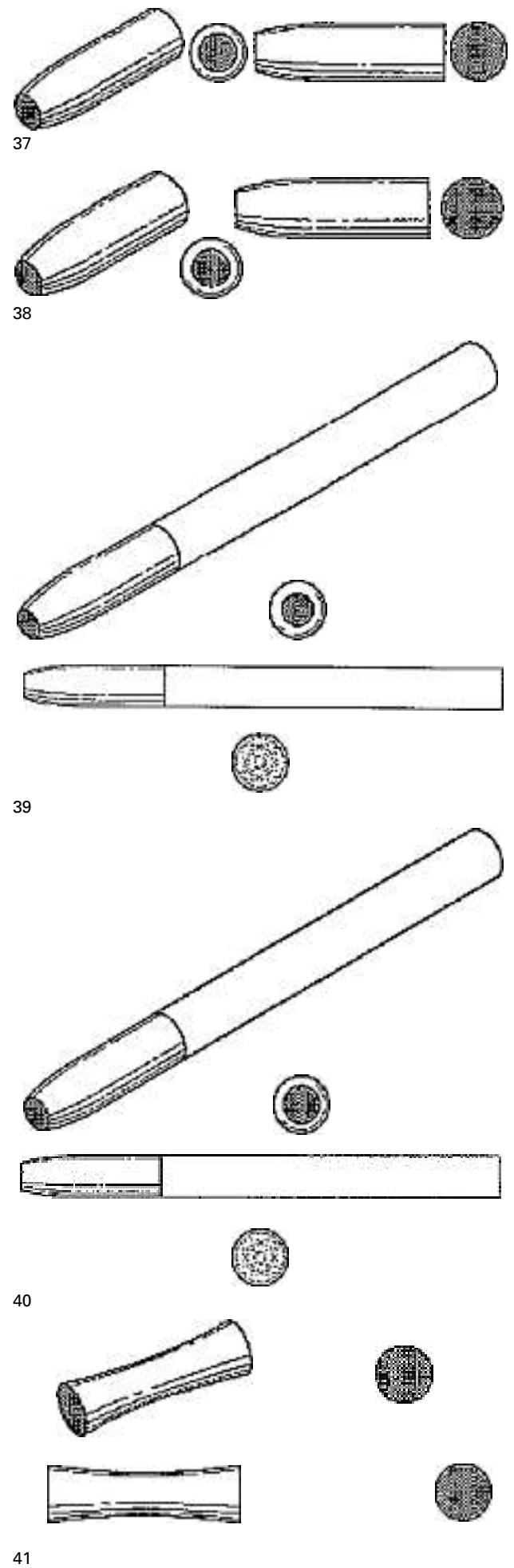
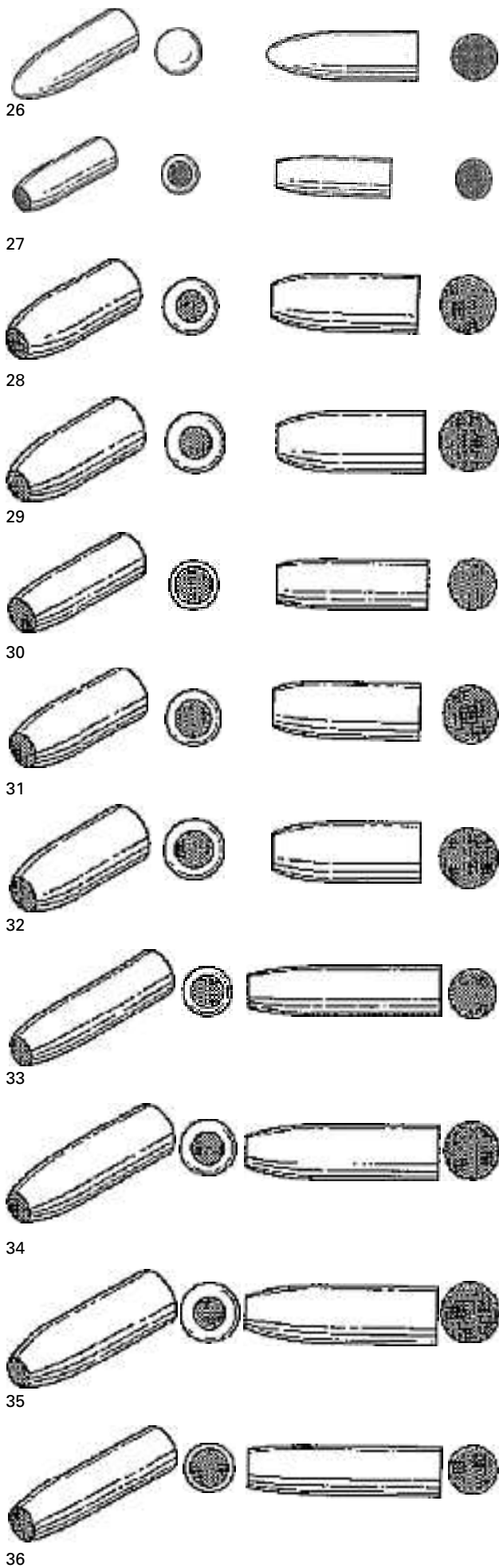

Cl. 31-00 131 743 13.04.2005
1 Design – Wasserkühler
Hinterleger: Swiss Water System (SWS) AG, Tödistrasse 16,
8002 Zürich
Designer: Markus Balkau, Schwanden GL
Vertreter: Isler & Pedrazzini AG, 8023 Zürich

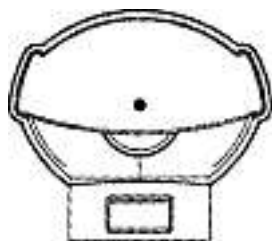
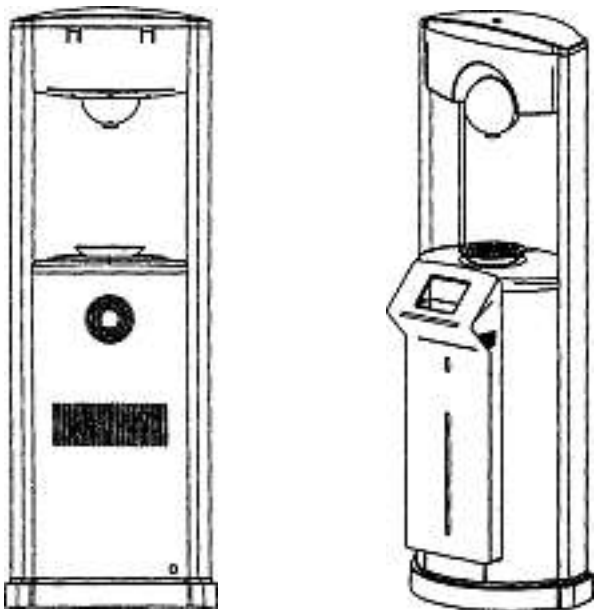
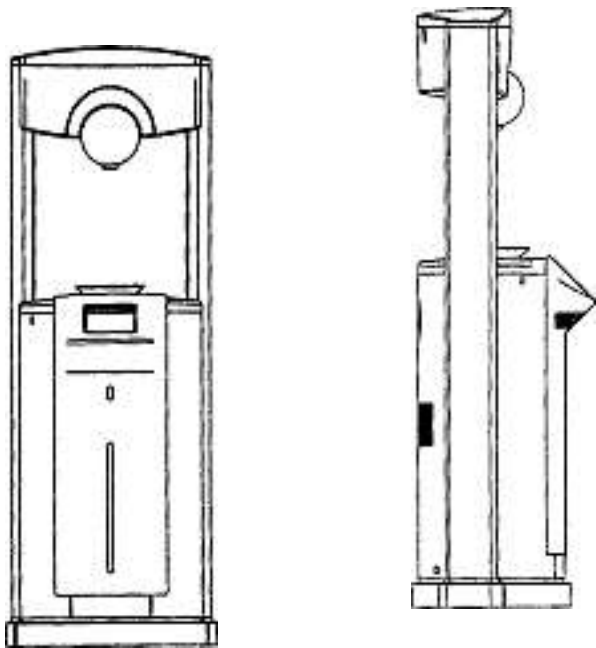

M13020

Verlängerungen Prolongations Prolongazioni

118 021 Cl. 06-01 4 Design



1





2



3



4

118 056 Cl. 25-04 1 design



1

118 172 Cl. 09-03 1 Design



1

118 233 Cl. 08-07 1 Design



1

118 249 Cl. 21-02 1 Design

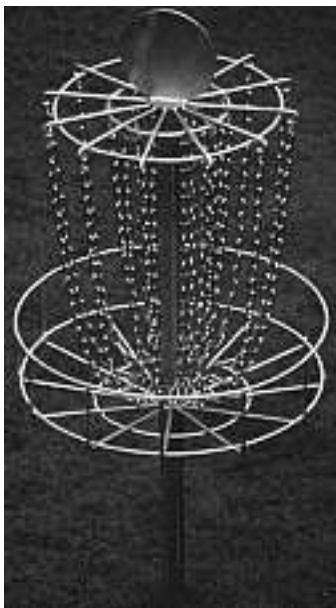

1

122 031	Cl.	05-05	169	Design
122 111	Cl.	06-08	1	Design
122 273	Cl.	06-04	1	Design
122 279	Cl.	07-06	1	Design
122 285	Cl.	09-03	1	Design
122 315	Cl.	26-05	1	Design
122 332	Cl.	09-01	1	Design
122 376	Cl.	19-01	1	Design
122 387	Cl.	23-02	1	Design
122 391	Cl.	03-01	1	Design
122 503	Cl.	30-04	1	Design
122 564	Cl.	10-02	1	Design
122 573	Cl.	20-02	1	Design
122 641	Cl.	08-05	2	Design
122 645	Cl.	09-01	1	Design
127 012	Cl.	03-01	1	Design
127 037	Cl.	23-01	2	Design
127 048	Cl.	06-04	4	Design
127 098	Cl.	04-02	3	Design
127 099	Cl.	04-02	3	Design
127 116	Cl.	08-08	1	Design
127 126	Cl.	19-08	1	Design
127 144	Cl.	09-01	1	design
127 145	Cl.	09-01	1	design
127 206	Cl.	01-01	1	Design
127 226	Cl.	15-09	6	Design
127 298	Cl.	19-02	5	Design
127 307	Cl.	23-01	1	Design
127 311	Cl.	25-01	1	Design
127 322	Cl.	03-01	2	Design

**Mutationen
Modifications
Modificazioni**

119 210

119 566

Transmission

Déposant: Potus Anstalt, Austrasse 42, Vaduz, LI

Mandataire: Jacobacci & Partners S.A., 1207 Genève

120 255

Übertragung

Namensänderung

Hinterleger: Hitachi Printing Solutions, Ltd., 15-1,

Konan 2-chome, Minato-ku, Tokyo, JP

Hinterleger: Ricoh Printing Systems, Ltd., 15-1,

Konan 2-chome, Minato-ku, Tokyo, JP

Vertreter: Ammann Patentanwälte AG Bern, 3001 Bern

122 332

Vertreter Firmaänderung

Vertreter: Braunpat Braun Eder AG, 4015 Basel

122 387

Neuer Vertreter

Vertreter: Schneider Feldmann AG, Patent- und

Markenanwälte, 8039 Zürich

127 063

Nouveau mandataire

Mandataire: CRONIN Intellectual Property, 1260 Nyon

131 540

Namensänderung

Hinterleger: AHT Cooling Systems GmbH, Werksgasse 57,

Rottenmann, AT

131 562

Neuer Vertreter

Vertreter: Büchel, von Révy & Partner, Patentanwälte,

9500 Wil SG

Löschungen
Radiations
Radiazioni

117 774	Cl.	07-02	1 Design
117 775	Cl.	07-02	1 Design
117 786	Cl.	09-05	1 Design
117 798	Cl.	25-01	3 Design
117 840	Cl.	14-03	1 Design
117 869	Cl.	12-15	1 design
121 800	Cl.	07-04	1 Design
121 801	Cl.	08-08	1 Design
121 806	Cl.	11-01	2 design
121 813	Cl.	18-02	1 Design
121 818	Cl.	19-06	1 Design
121 822	Cl.	21-01	1 design
121 833	Cl.	26-05	1 Design
121 836	Cl.	04-01	2 Design
121 863	Cl.	24-04	2 design
121 870	Cl.	04-02	1 Design
121 940	Cl.	14-03	1 design
122 008	Cl.	12-16	1 Design
126 448	Cl.	06-03	2 Design
126 450	Cl.	06-04	1 Design
126 451	Cl.	19-04	31 Design
126 452	Cl.	07-01	1 Design
126 457	Cl.	09-05	2 Design
126 463	Cl.	14-02	4 Design
126 469	Cl.	20-02	2 Design
126 481	Cl.	06-06	20 Design
126 483	Cl.	06-04	73 Design
126 484	Cl.	06-04	2 Design
126 487	Cl.	07-05	1 Design
126 489	Cl.	08-08	3 design
126 492	Cl.	09-03	2 Design
126 493	Cl.	10-02	1 Design
126 496	Cl.	10-07	12 Design
126 498	Cl.	11-02	144 Design
126 501	Cl.	14-01	1 Design
126 503	Cl.	14-02	1 Design
126 504	Cl.	14-03	1 Design
126 505	Cl.	14-03	1 Design
126 510	Cl.	20-02	2 Design
126 512	Cl.	21-01	1 Design
126 513	Cl.	21-02	2 Design
126 516	Cl.	24-04	1 Design
126 519	Cl.	01-01	2 Design
126 633	Cl.	07-02	1 design
126 635	Cl.	09-03	2 Design

Cl. 05-05

131 685

21.04.2005

1



2



3



4



5



6



7



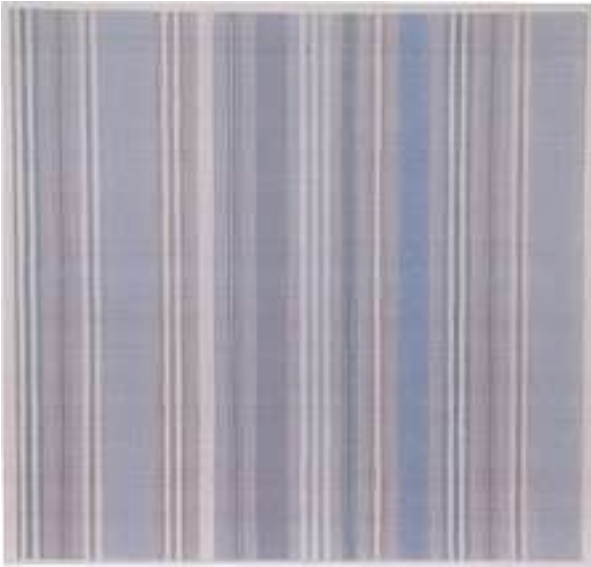

8

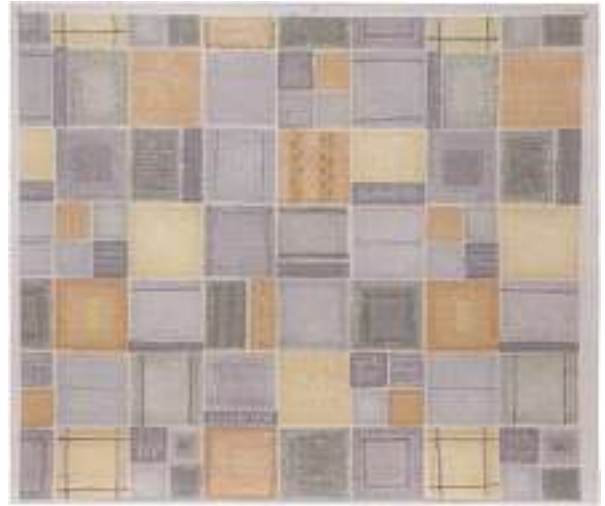

11

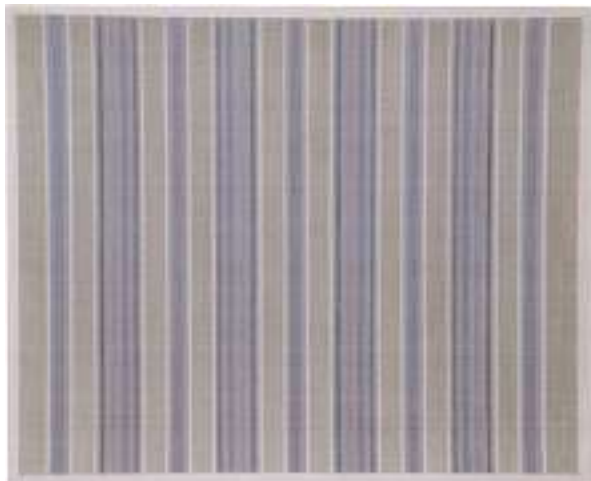

9

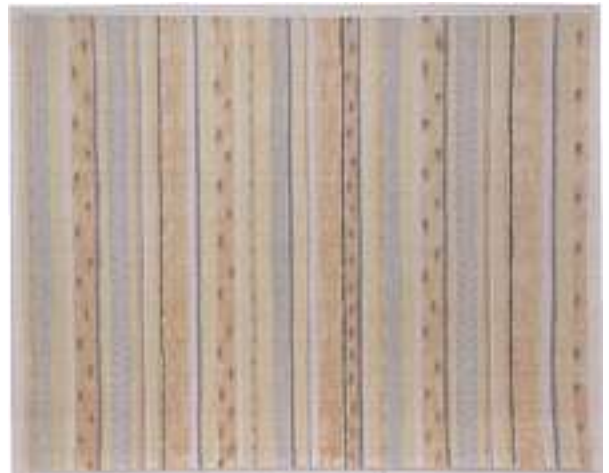

12



10

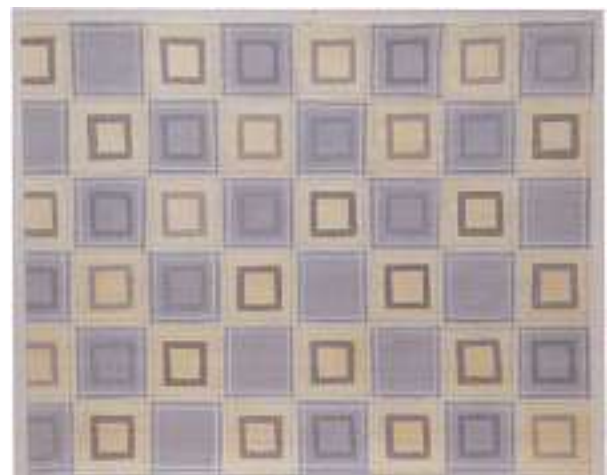

13



14



17



15



18

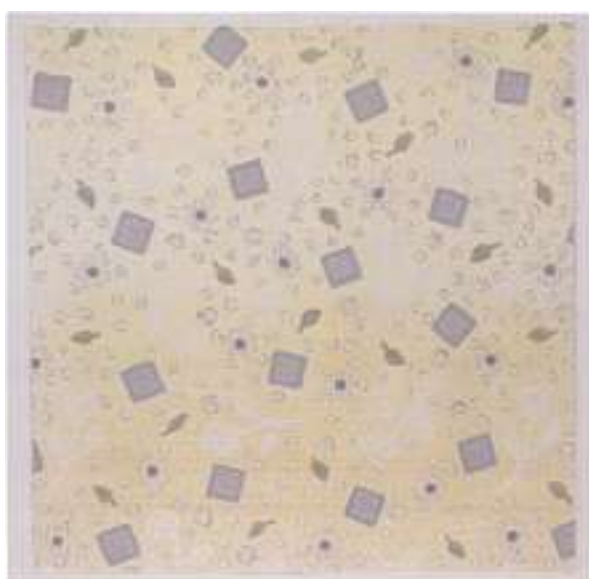

16



19



20

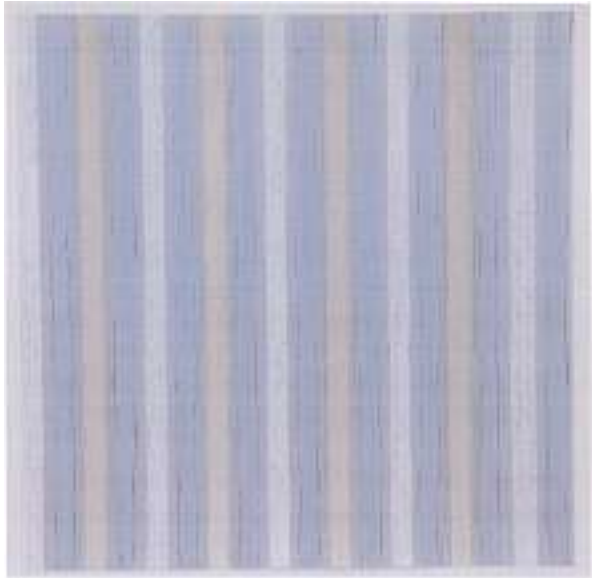

21

Cl. 06-13

131 698

25.04.2005



14474A

4 Farbteil



14474B

Cl. 09-03

131 706

23.03.2005



A-2005/1013a



A-2005/1013b



A-2005/1013c



A-2005/1013d

Cl. 12-12

131 727

13.04.2005





2



1

3

Cl. 19-08

131 733

18.01.2005



1

4



5



8



6



9



7



10



11



14



12



15



13

Cl. 21-01

131 736

30.04.2005



1290 I 311/C



3

Cl. 25-01

131 738

06.04.2005



1



4



2

Cl. 26-05

131 741

22.04.2005



01-05