

Nationale Hinterlegungen

In der folgenden Liste werden die beim Eidgenössischen Institut für Geistiges Eigentum hinterlegten Designs publiziert. Dabei sind der Reihe nach angegeben:

- internationale Klassenangaben
- Hinterlegungsnummer
- Hinterlegungsdatum
- Allenfalls Aufschub der Veröffentlichung
- Anzahl der hinterlegten Designs
- Bezeichnung
- Name und Wohnsitz des Hinterlegers oder der Hinterlegerin
- gegebenenfalls Name und Wohnsitz des Designers oder der Designerin
- Name und Geschäftssitz des allfälligen Vertreters oder der Vertreterin
- gegebenenfalls Prioritätsangaben
- gegebenenfalls Beschreibungstext
- Ordnungsnummer
- Reproduktion des Designs

Internationale Hinterlegungen

Die bei der Weltorganisation für geistiges Eigentum in Genf hinterlegten Muster und Modelle mit Benennung Schweiz geniessen den gleichen Schutz wie national hinterlegte Designs. Sie werden jeweils im Blatt «Bulletin des dessins et modèles internationaux» veröffentlicht. Dieses Publikationsorgan ist deshalb für eine vollständige Recherche unbedingt beizuziehen.

Topographien

Angaben über die vom Eidgenössischen Institut für Geistiges Eigentum eingetragenen Topographien von Halbleitererzeugnissen werden in folgender Anordnung aufgeführt:

- Eintragsnummer
- Anmeldedatum
- Bezeichnung
- Name und Wohnsitz des Anmelders oder der Anmelderin
- gegebenenfalls Name und Wohnsitz des Herstellers oder der Herstellerin
- Name und Geschäftssitz des oder der allfälligen Bevollmächtigten
- Datum und Ort einer allfälligen ersten geschäftlichen Verbreitung der Topographie

Dépôts nationaux

Les designs déposés à l'Institut Fédéral de la Propriété Intellectuelle sont publiés dans la liste qui suit. Les indications y relatives sont mentionnées dans cet ordre:

- indications des classes internationales
- numéro de dépôt
- date de dépôt
- le cas échéant, ajournement de la publication
- nombre des designs déposés
- désignation
- nom et domicile du/de la déposant/e
- le cas échéant, nom et domicile du/de la designer
- nom et domicile de l'éventuel/le mandataire
- le cas échéant, indication de priorité
- le cas échéant, description du design
- numéro attribué à chaque design
- reproduction du design

Dépôts internationaux

Les dessins et modèles déposés à l'Organisation Mondiale de la Propriété Intellectuelle à Genève qui désignent la Suisse jouissent de la même protection que les dépôts nationaux. Ils sont chaque fois publiés dans la feuille «Bulletin des dessins et modèles internationaux». Pour une recherche complète, il est indispensable de consulter ledit organe de publication.

Topographies

Les indications concernant les topographies des produits semi-conducteurs, enregistrées par l'Institut Fédéral de la Propriété Intellectuelle, sont énumérées dans l'ordre suivant:

- numéro d'enregistrement
- date de dépôt
- désignation
- nom et domicile du/de la déposant/e
- le cas échéant, nom et domicile du/de la producteur/trice
- nom et domicile de l'éventuel/le mandataire
- date et lieu d'une éventuelle première mise en circulation de la topographie

Depositi nazionali

Nella lista seguente vengono pubblicati i design depositati presso l'Istituto Federale della Proprietà Intellettuale. Sono menzionati nel seguente ordine:

- indicazioni delle classi internazionali
- numero di deposito
- data del deposito
- se del caso, indicazione che la pubblicazione è stata differita
- numero dei design depositati
- designazione
- nome e domicilio del depositante
- se del caso, nome e domicilio del designer
- nome e sede di un eventuale mandataro
- se del caso, indicazioni di priorità
- se del caso, descrizione del design
- numero d'ordine
- riproduzione del design

Depositi internazionali

I disegni e modelli depositati presso l'Organizzazione Mondiale della Proprietà Intellettuale a Ginevra con denominazione Svizzera godono della medesima protezione del deposito nazionale. Essi vengono pubblicati ogni volta nel foglio «Bulletin des dessins et modèles internationaux». Quest'organo di pubblicazione è da consultare se si vuole effettuare una ricerca completa.

Topografie

Le indicazioni concernenti le topografie di prodotti a semiconduttori depositati presso l'Istituto Federale della Proprietà Intellettuale sono menzionate nell'ordine seguente:

- numero di registrazione
- data del deposito
- designazione
- nome e domicilio del/la richiedente
- se del caso, nome e domicilio del/la produttore/trice
- nome e sede di un eventuale mandataro
- data e luogo di un'eventuale prima messa in circolazione della topografia

Hinterlegungen
Dépôts
Deposit

Cl. 11-01 129 698 08.07.2003
1 design – bague
Déposant: Richemont International S.A., Route des Biches 10,
1752 Villars-sur-Glâne
Designer: Anne Cabarbaye, Blonay
Mandataire: Micheli & Cie, 1226 Thônex (Genève)
Fin de la période ajournement de la publication

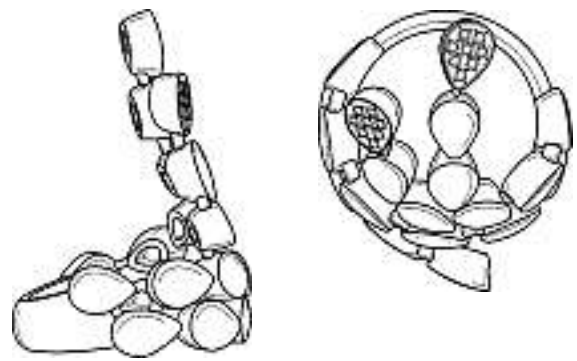
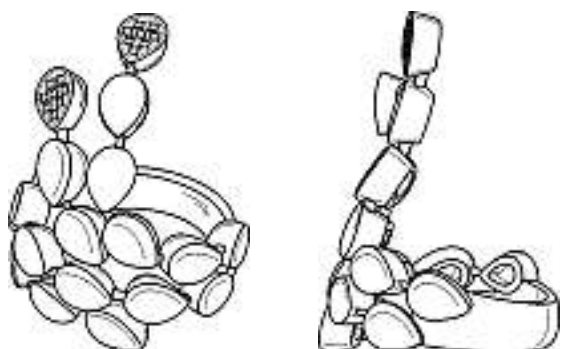
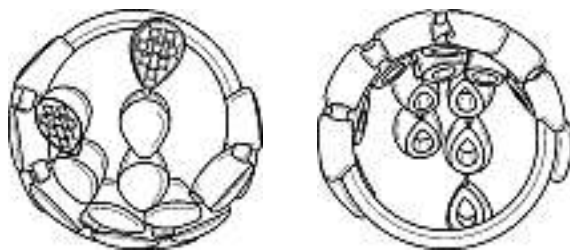
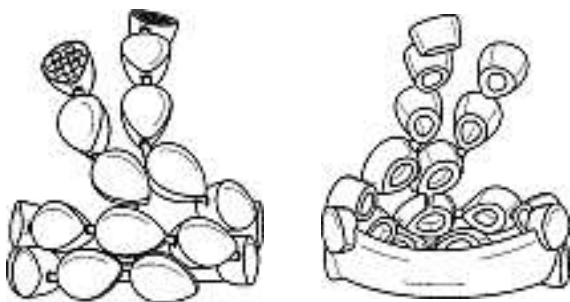
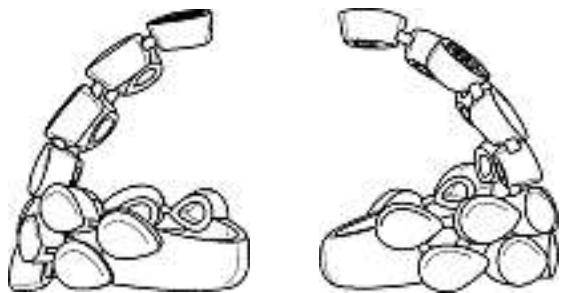

13988

Cl. 03-01 132 380 11.11.2005
1 Design – Tasche
Hinterleger: ciné mask ag, Beatengasse 9, 8001 Zürich
Designer: Beatrice Petri, Zürich





setbag

Cl. 06-02 132 381 06.12.2005

1 Design – Bett

Hinterleger: HESS Medizintechnik AG, Im Schossacher 21, 8600 Dübendorf

Designer: Walter Zannier, Mitlödi

Vertreter: Meyer Marks AG, 5620 Bremgarten AG



1

Cl. 07-01

132 382

05.12.2005

1 Design – Krug

Hinterleger: Dart Industries Inc., 14901 S. Orange Blossom Trail, Orlando / FL, US

Designer: Jakob Heiberg, Charlottenlund; Dorte Sondergaard, Frederiksberg

Vertreter: A. Braun, Braun, Héritier, Eschmann AG, Patentanwälte, 4051 Basel

Priorität: US, 08.06.2005

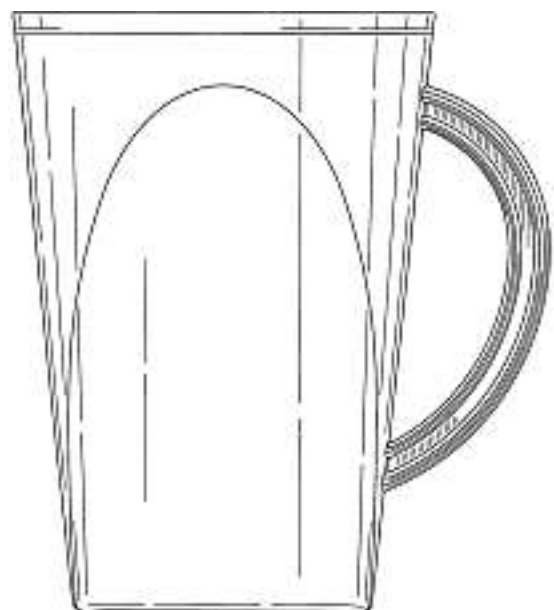
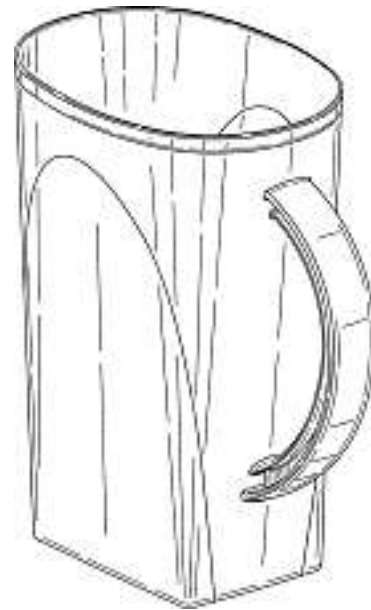

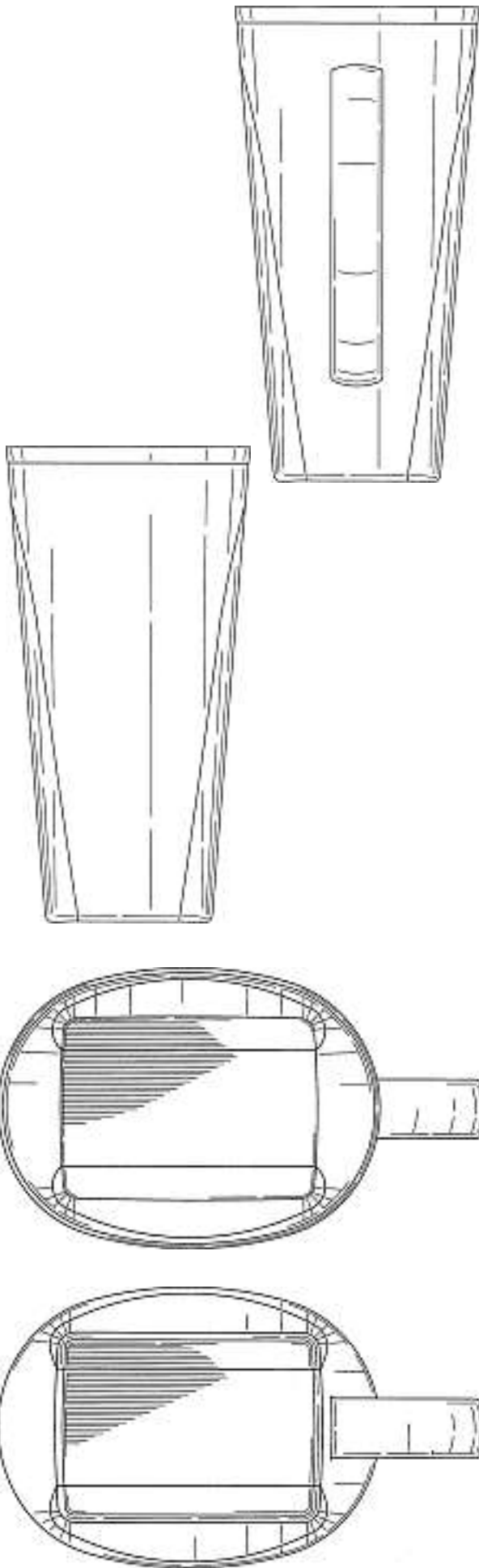

1

Cl. 07-01 132 383 05.12.2005
 1 Design – Deckel
 Hinterleger: Dart Industries Inc., 14901 S. Orange Blossom Trail, Orlando / FL, US
 Designer: Jakob Heiberg, Charlottenlund; Dorte Sondergaard, Frederiksberg
 Vertreter: A. Braun, Braun, Hérítier, Eschmann AG, Patentanwälte, 4051 Basel
 Priorität: US, 08.06.2005

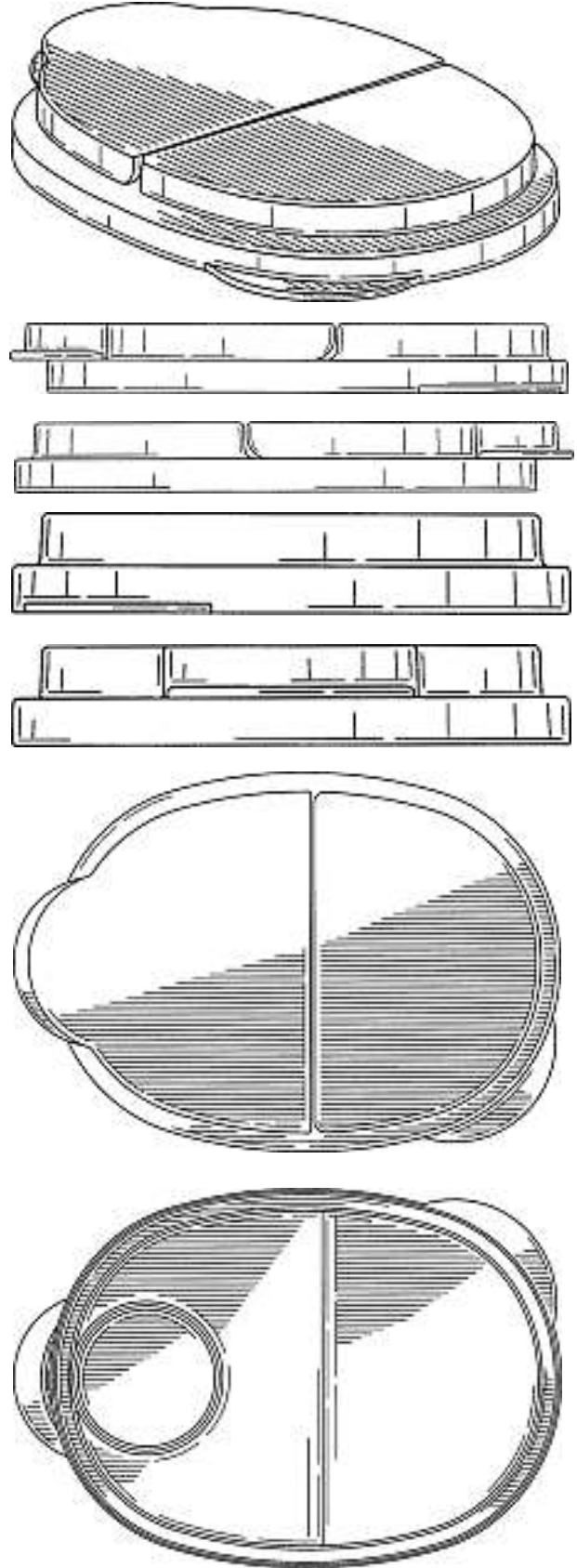

1

Cl. 07-01 132 384 05.12.2005
12 Design – Trinkgläser
Hinterleger: PI-DESIGN AG, Kantonsstrasse 100,
6234 Triengen
Designer: Jorgen Bodum, St. Niklausen
Vertreter: Isler & Pedrazzini AG, 8023 Zürich
Priorität: DK, 07.06.2005

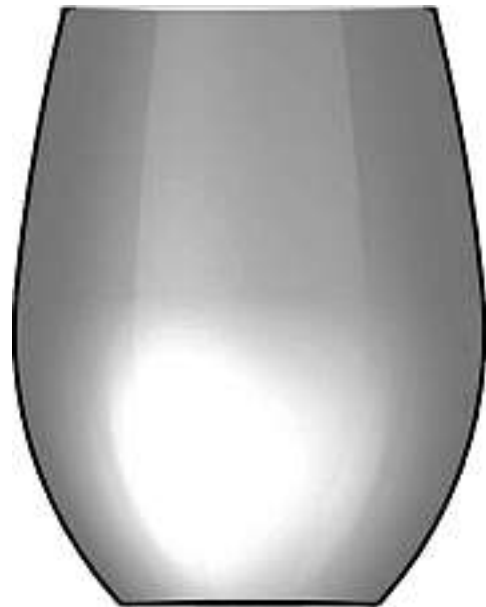
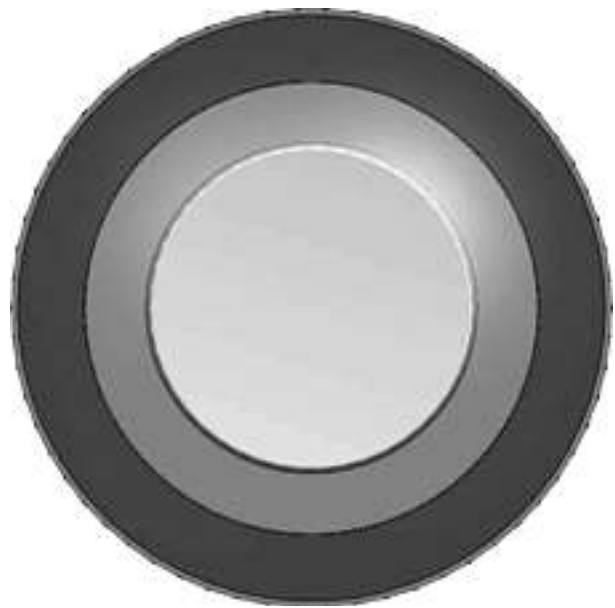

1

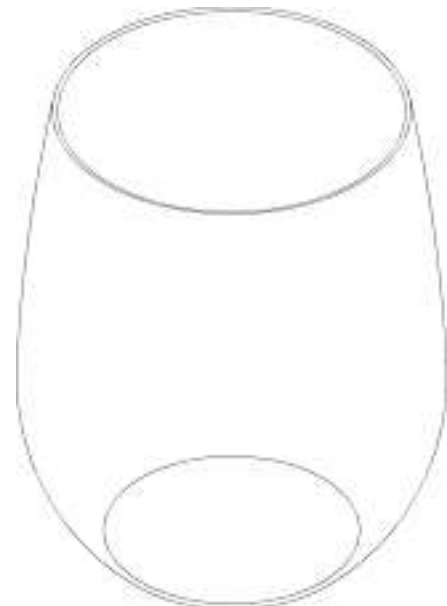

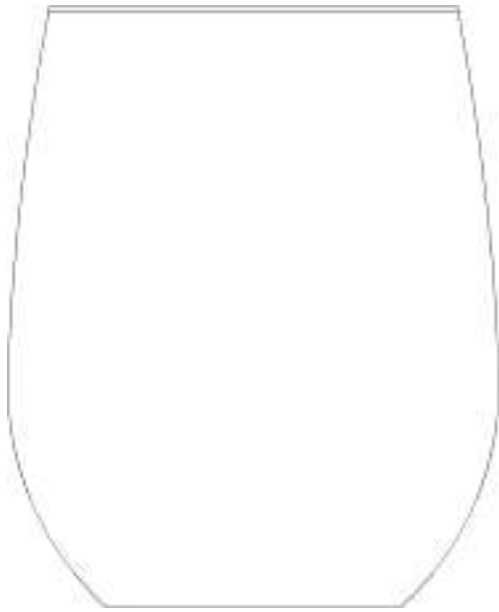

2

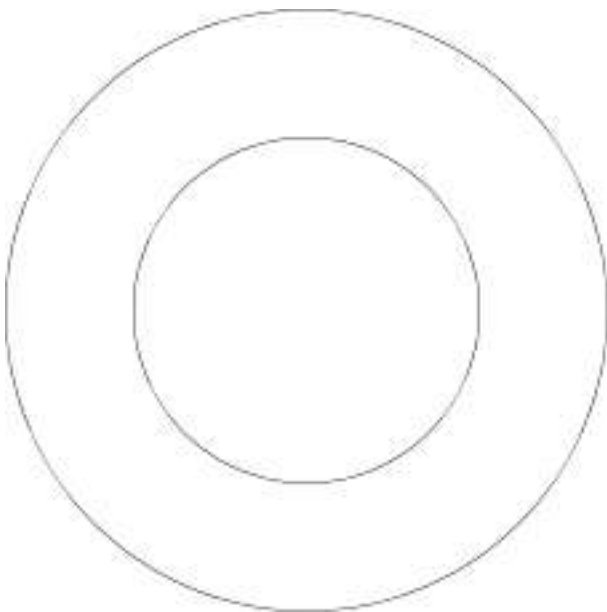
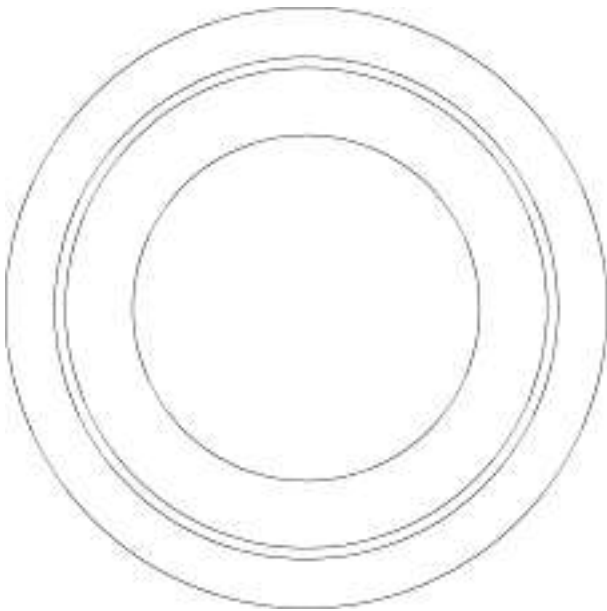

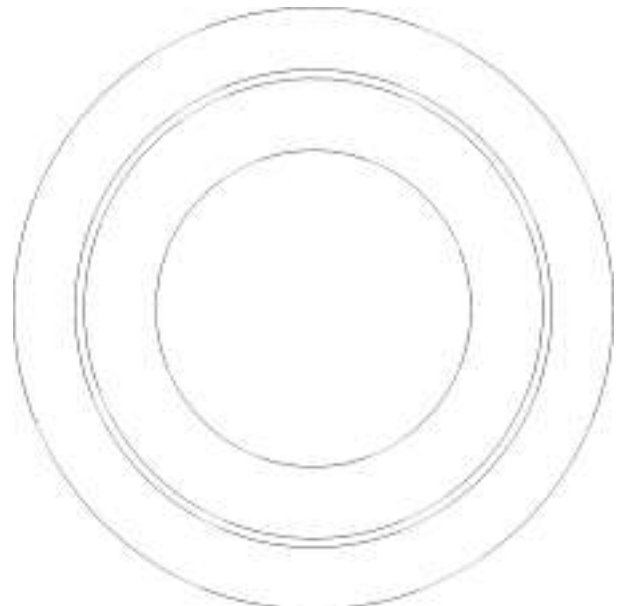

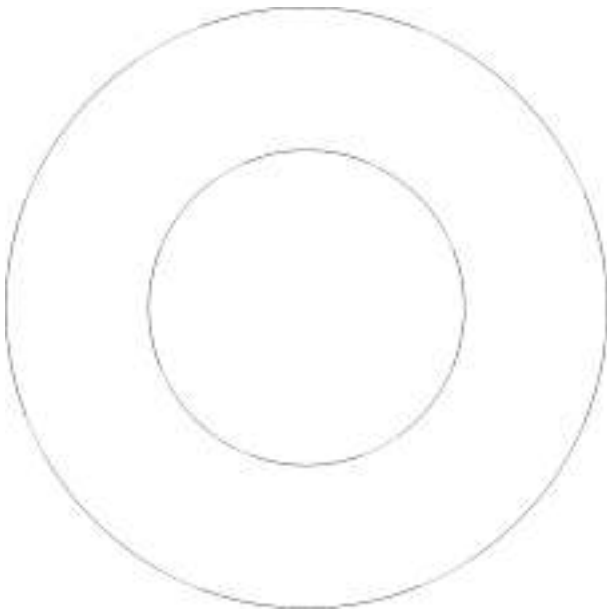

4

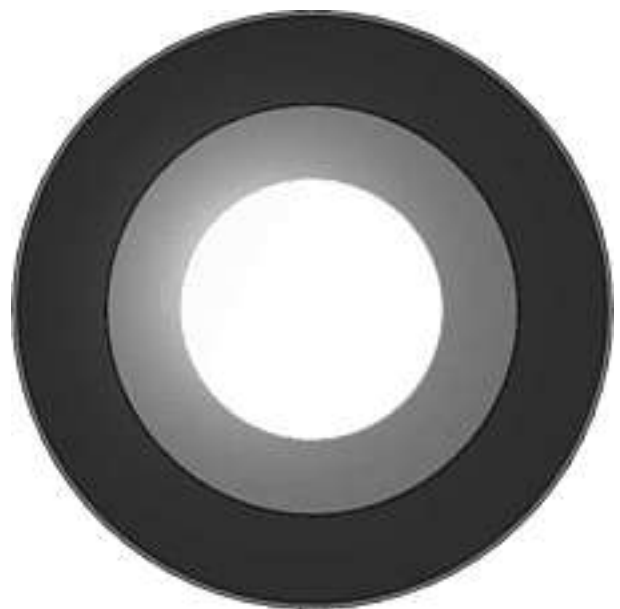

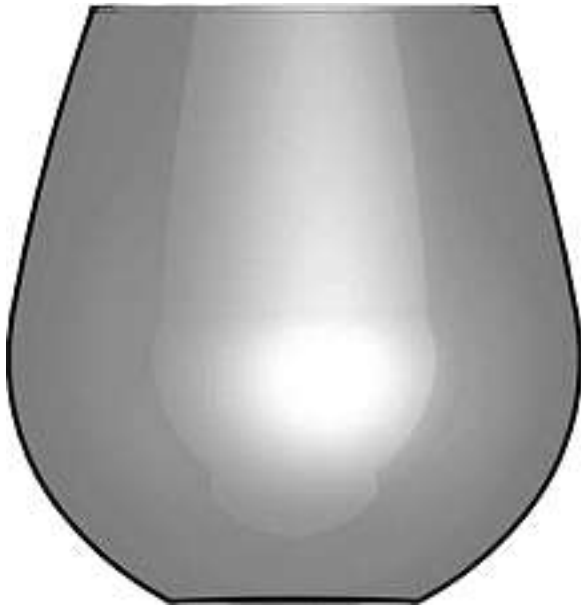

5

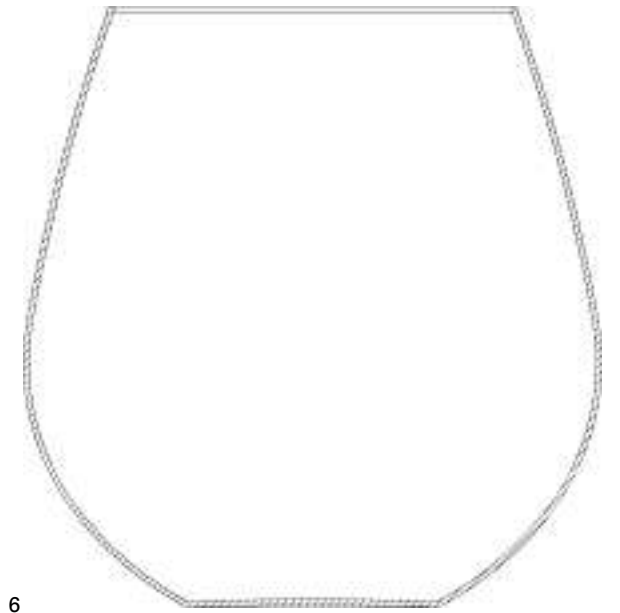
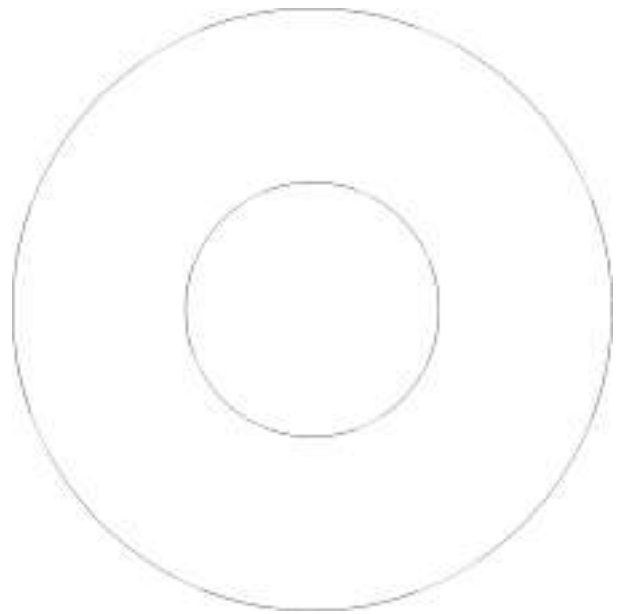
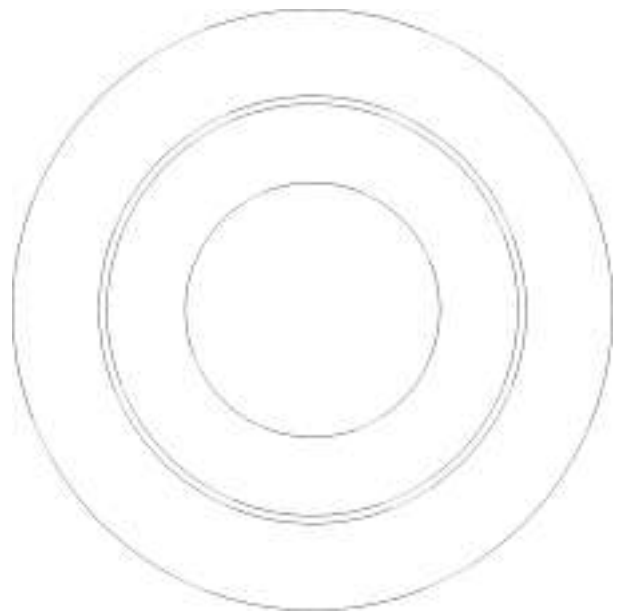
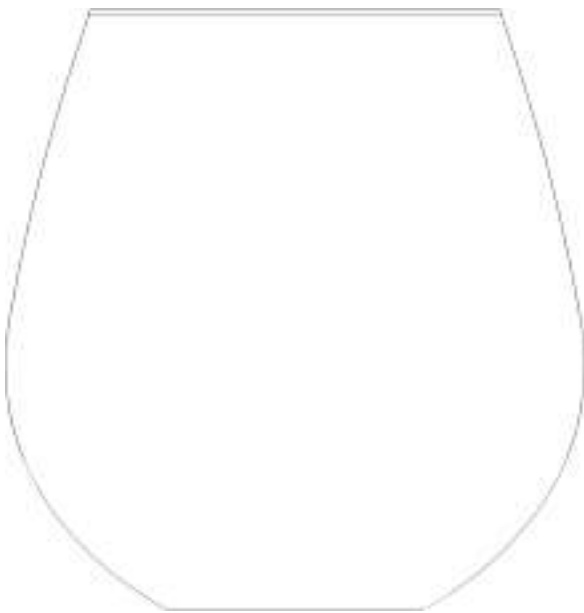

6



7

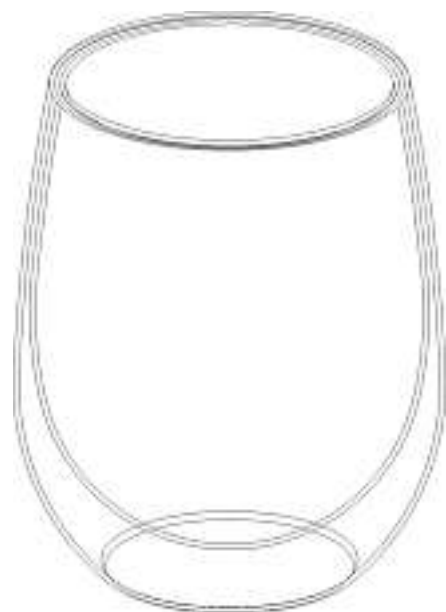

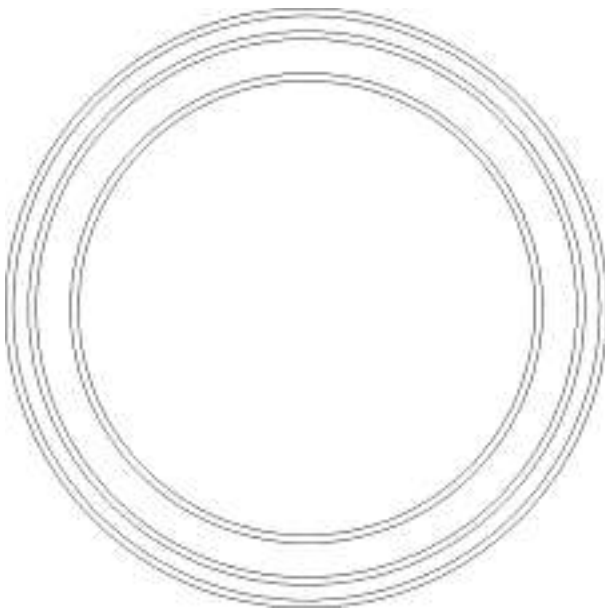
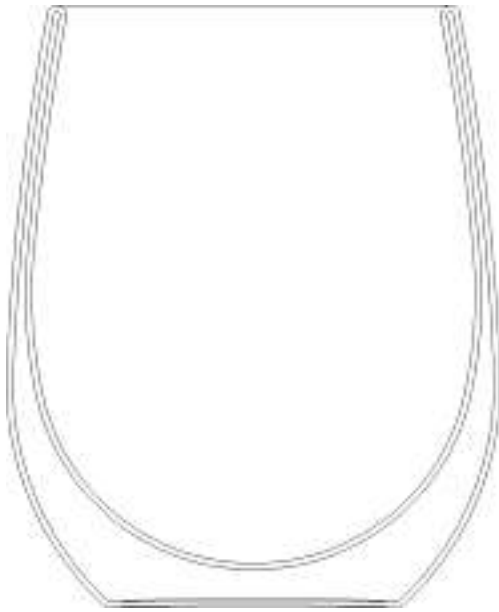

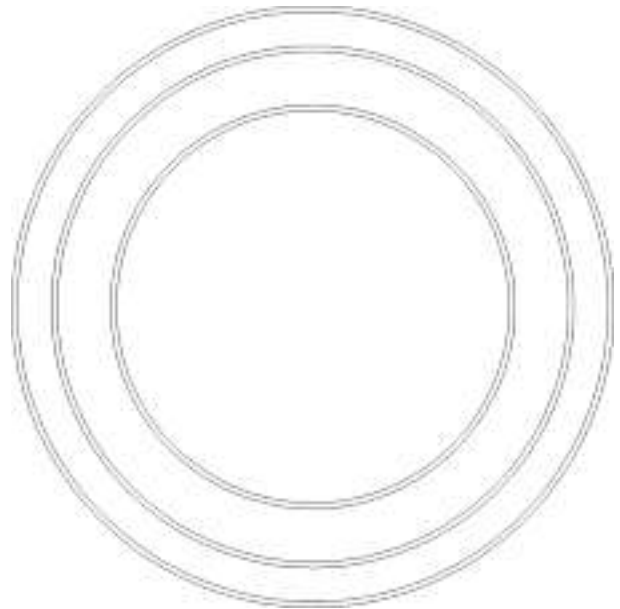
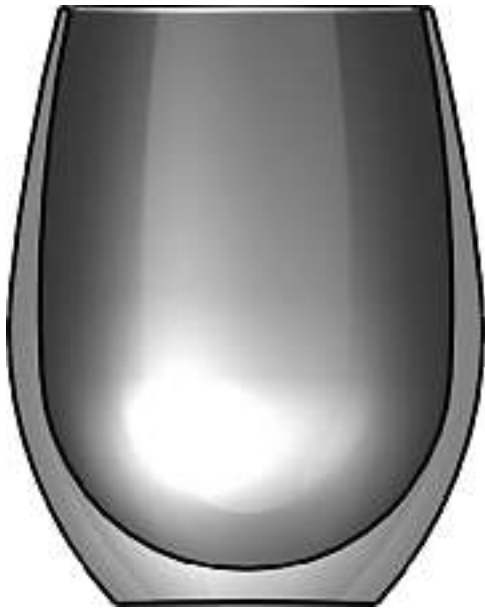
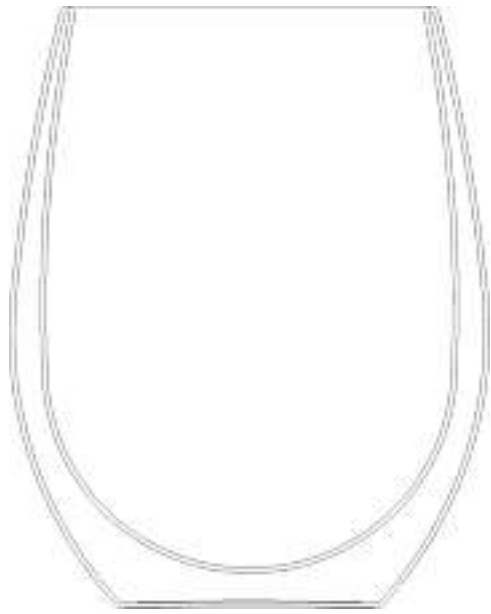

9



10

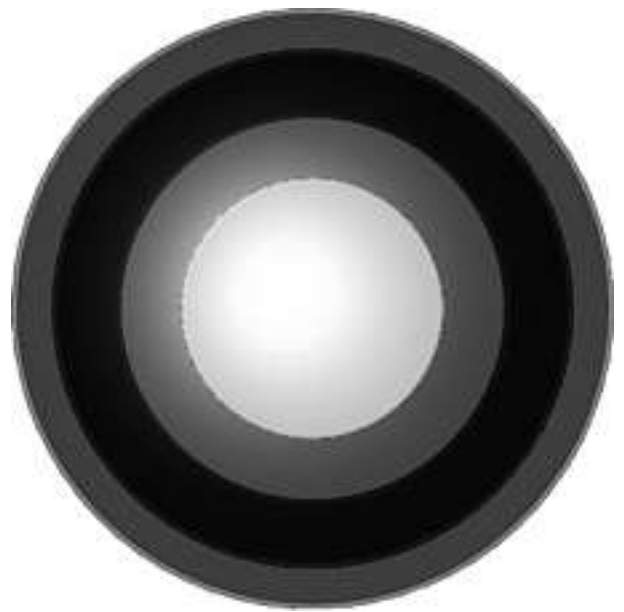

11



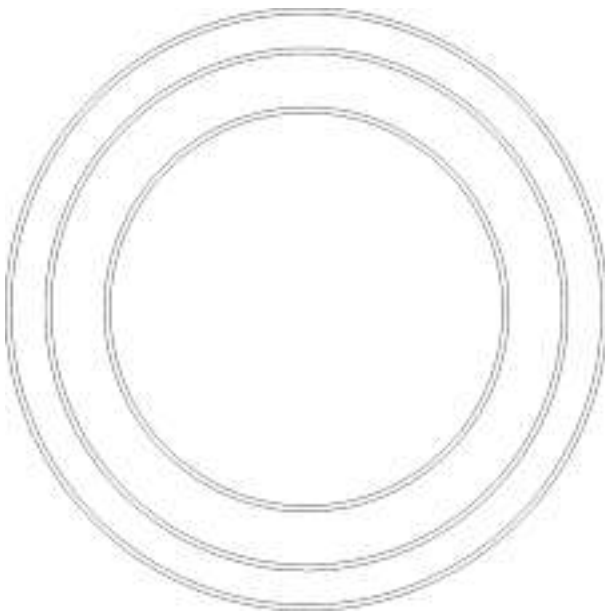

Cl. 07-01 132 385 08.12.2005
22 Design – Trinkgläser
Hinterleger: PI-DESIGN AG, Kantonsstrasse 100,
6234 Triengen
Designer: Jorgen Bodum, St. Niklausen
Vertreter: Isler & Pedrazzini AG, 8023 Zürich
Priorität: DK, 09.06.2005



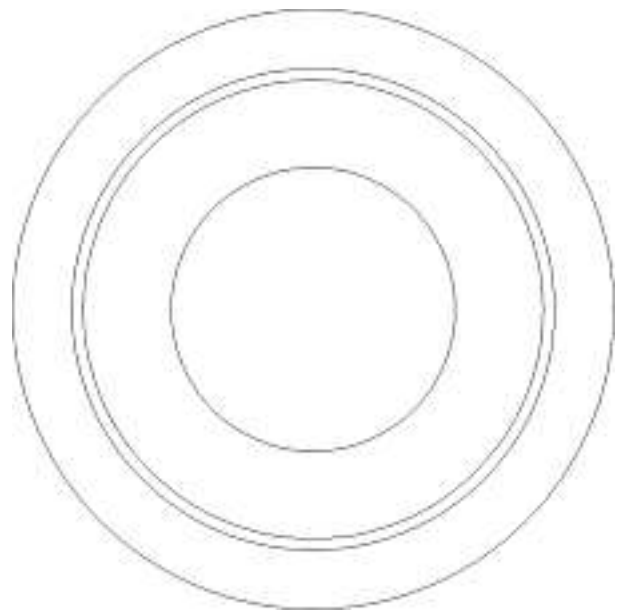
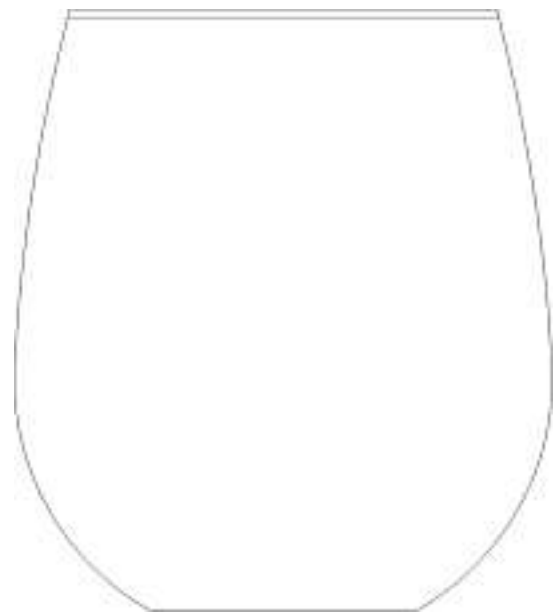

1

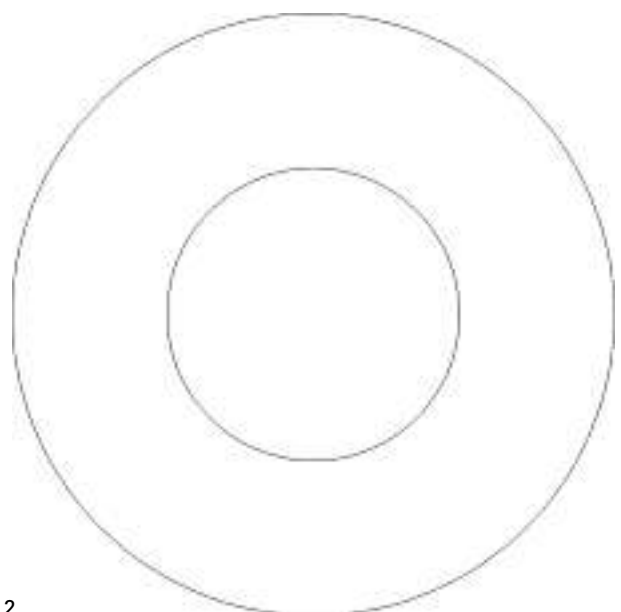

2



3



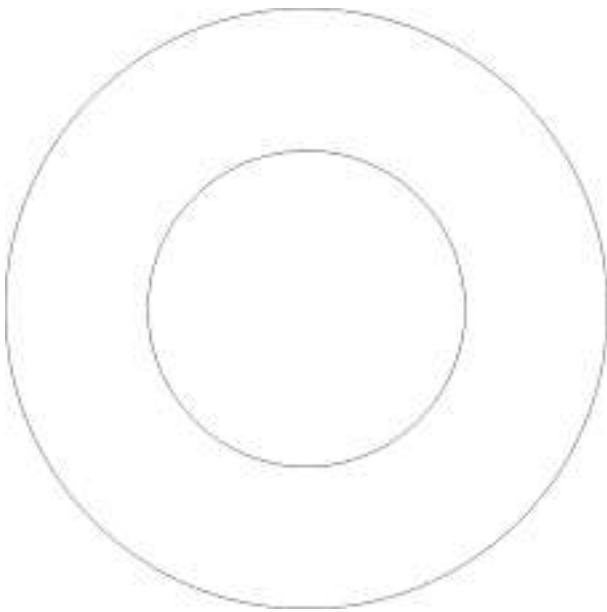
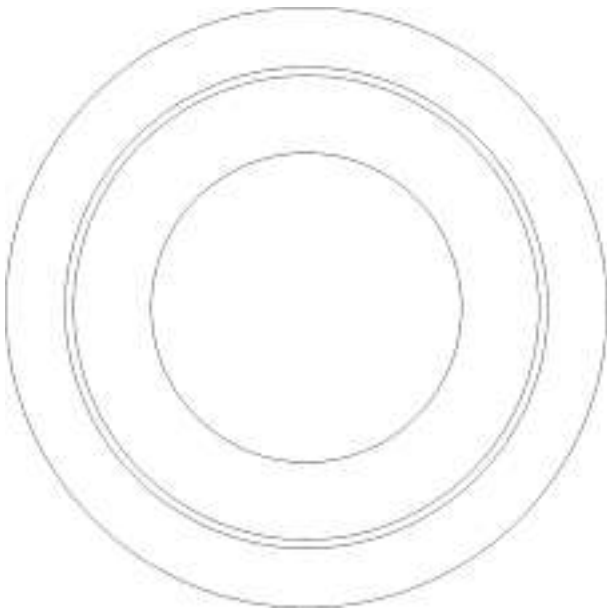

4

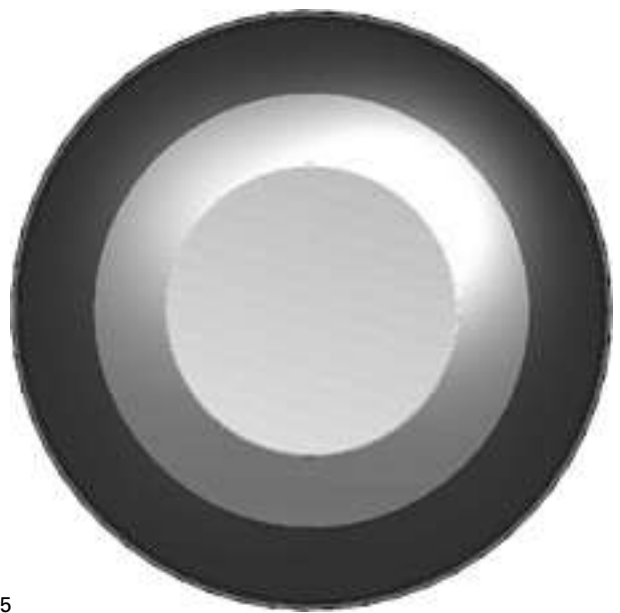

5

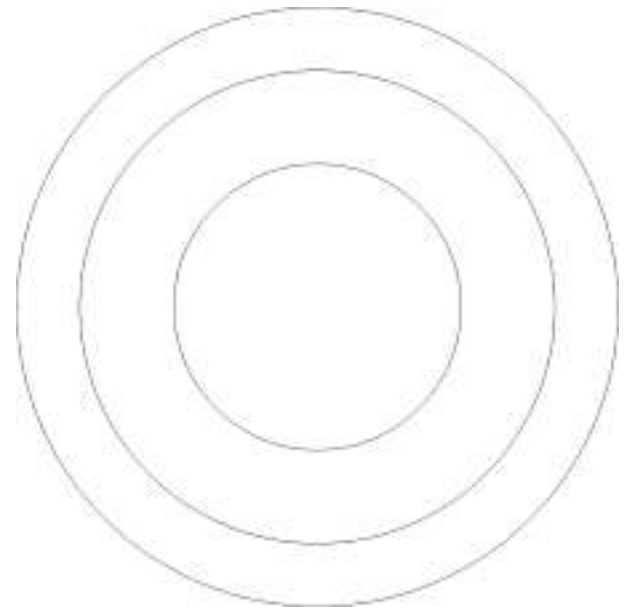

6

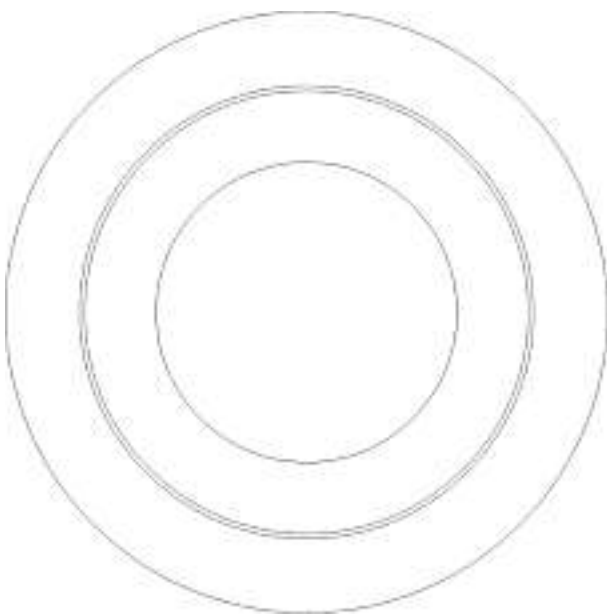
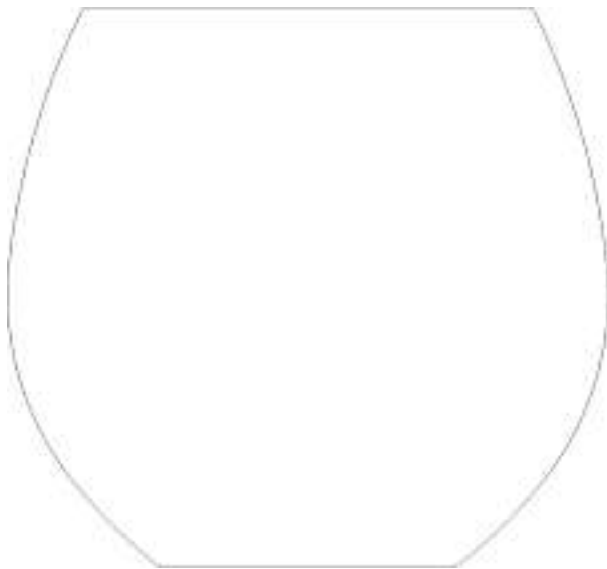



7

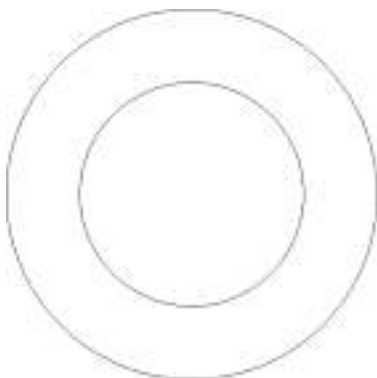
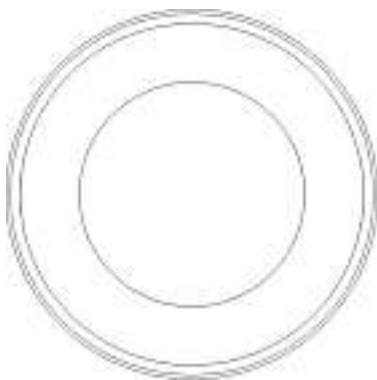

8

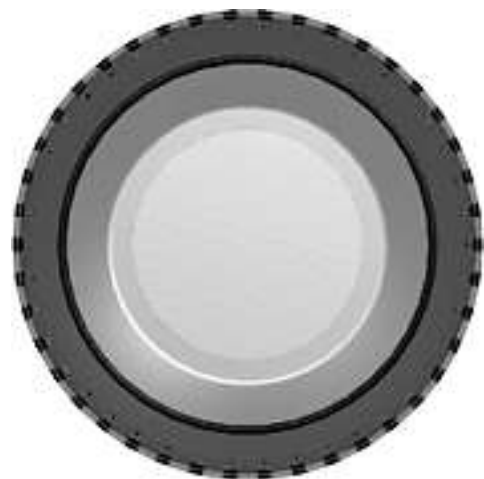

9

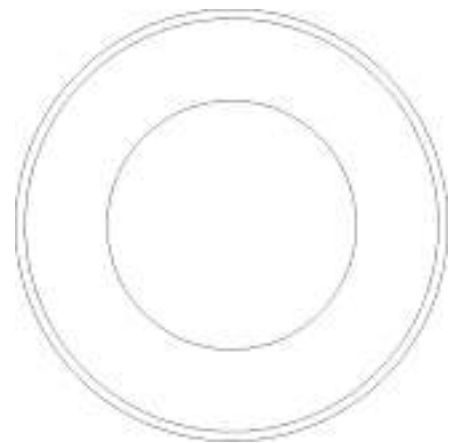
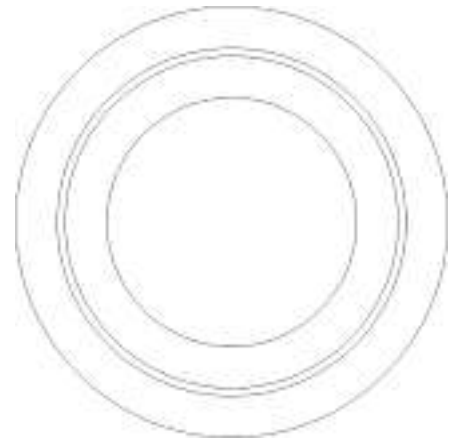

10



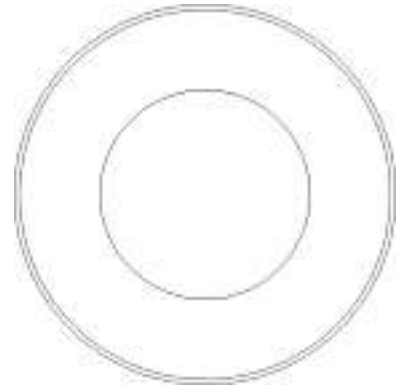
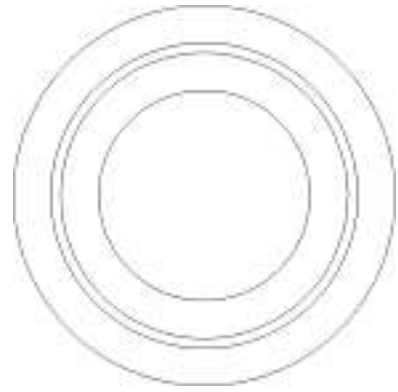

12



11





13

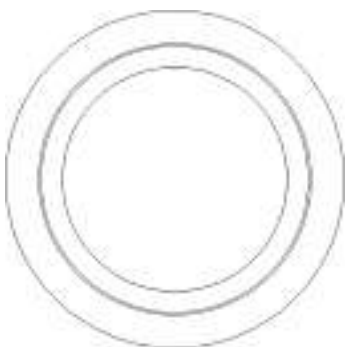
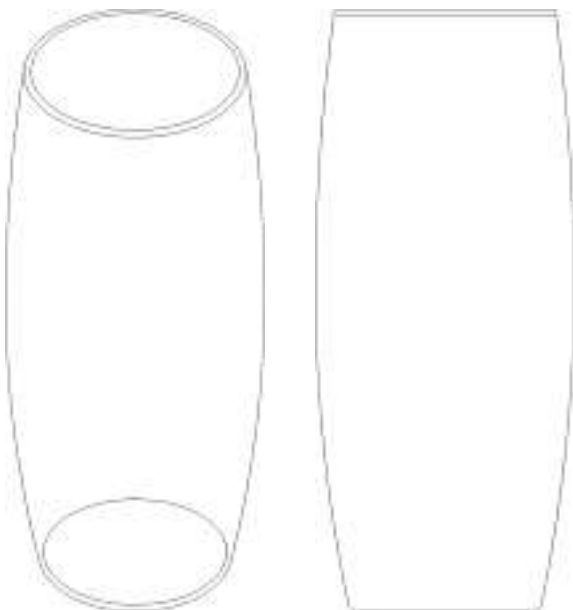

14

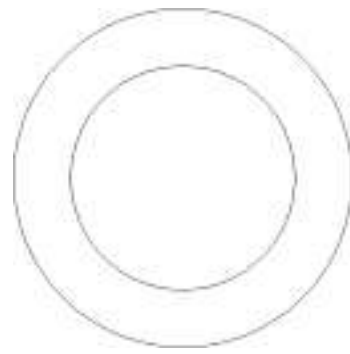

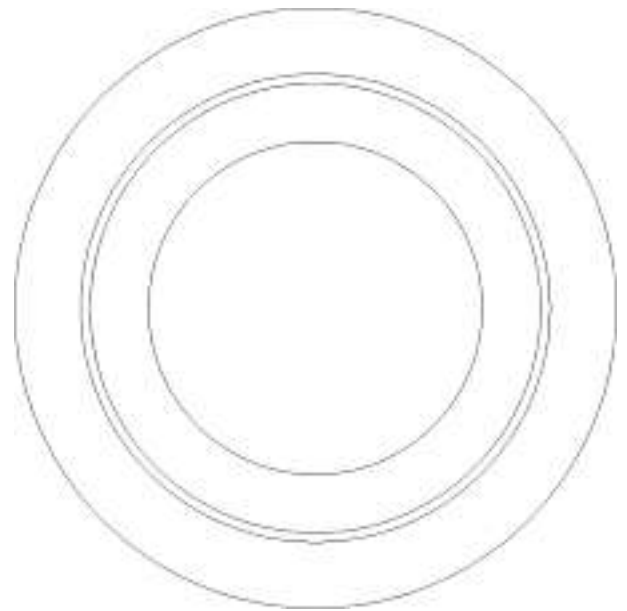
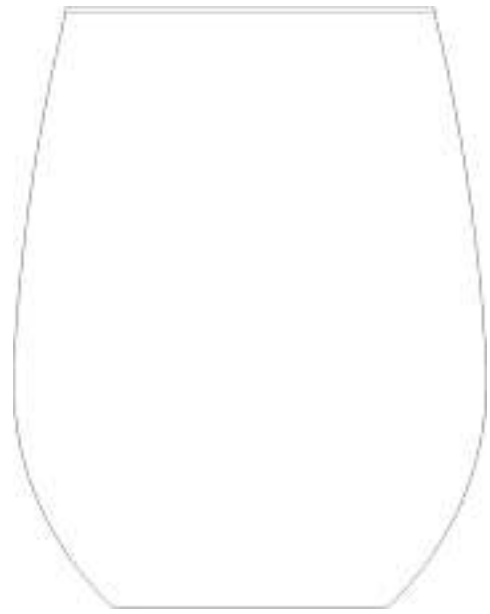

15

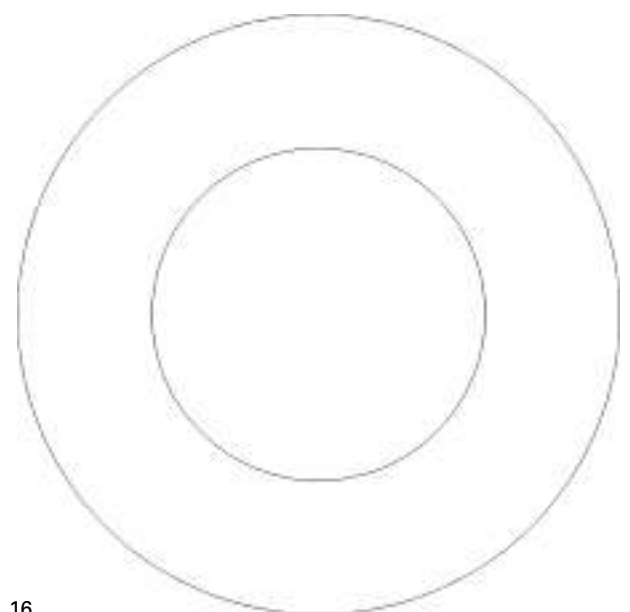

16



17

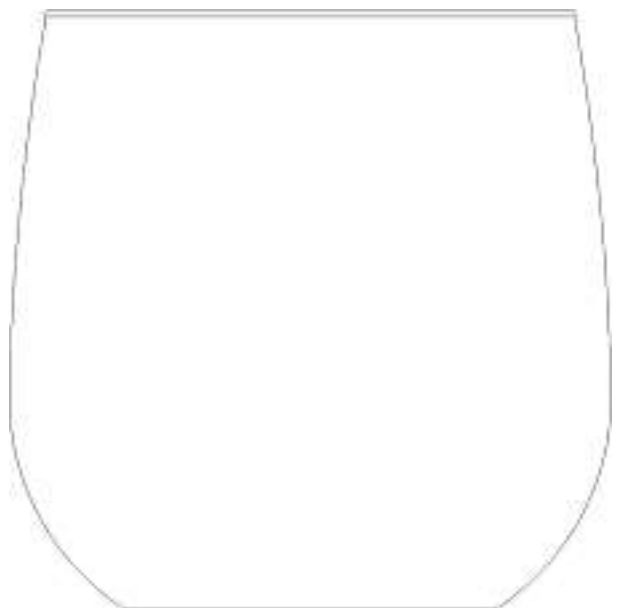

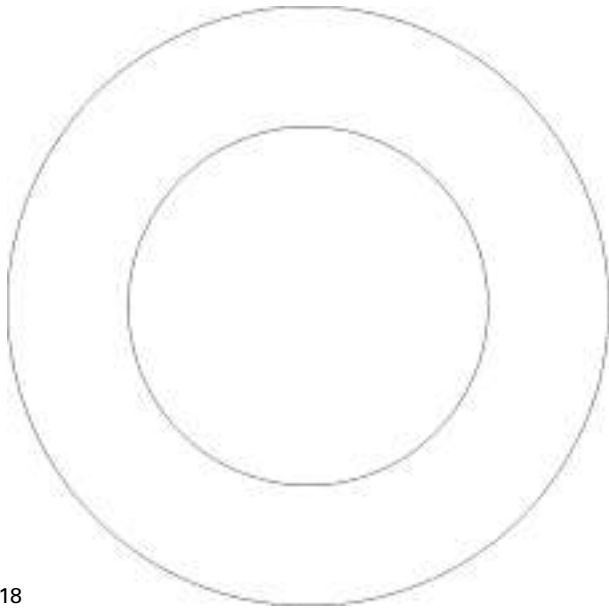
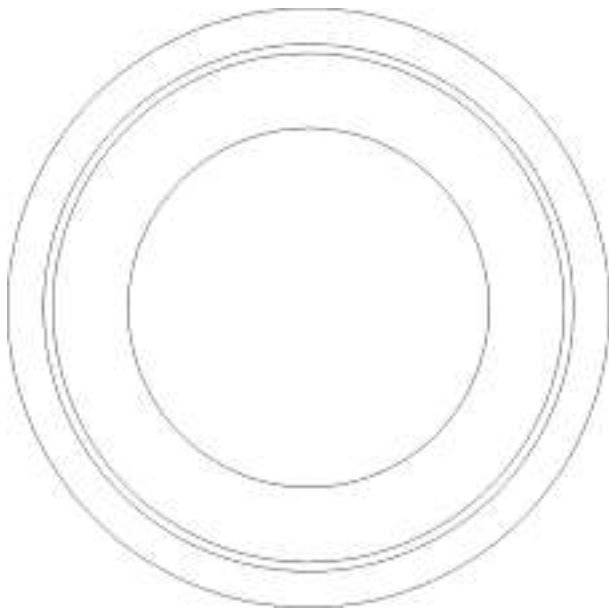

18



19



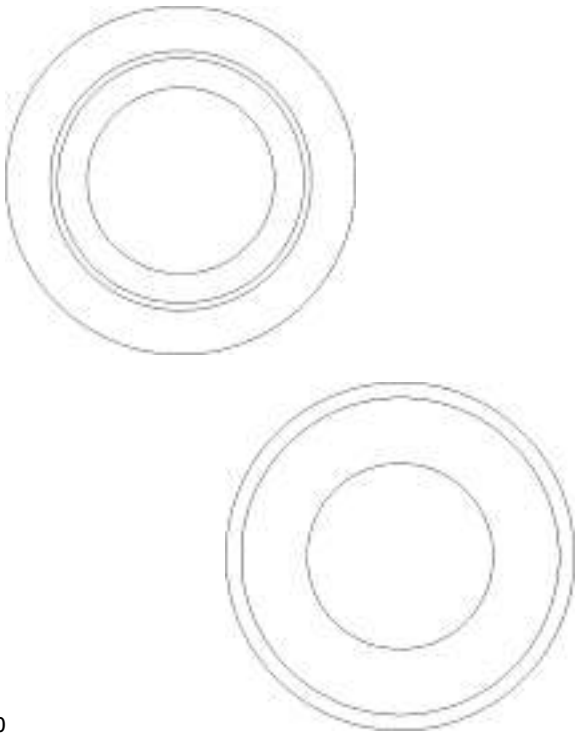

20



21



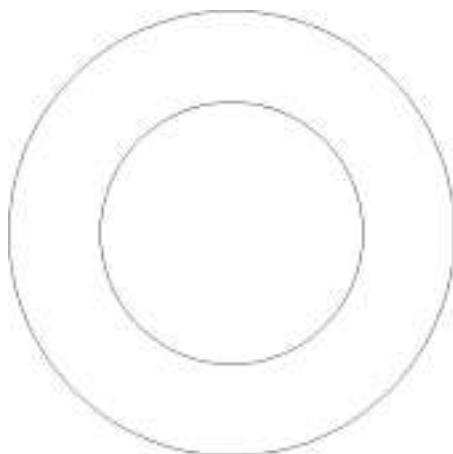
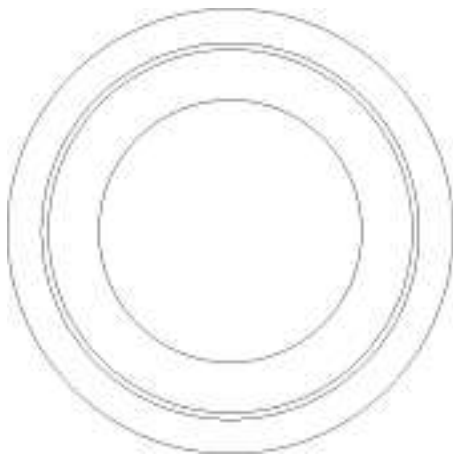

Cl. 07-99 132 386 14.11.2005
 1 Design – Zeitungsständer
 Hinterleger: Christoph Körner, Ginsterweg 3, Köln, DE
 Designer: Florence Keulen, Oirsbeek; Merlijn van Kan, Eijsden; Evelien van Tuijl, Sittard; Audrey Stevens, Valkenburg; Lindsay Meeks, Stein; Malu Kirschbaum, Maastricht; Lobke Theelen, Neer; Wendy Janssen, Maastricht
 Vertreter: Isler & Pedrazzini AG, 8023 Zürich
 Priorität: BX, 15.05.2005

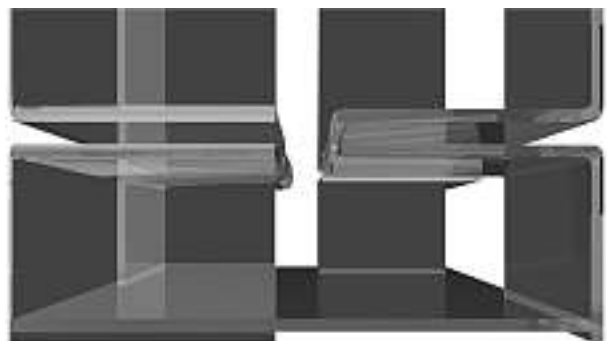



M13092

Cl. 09-01 132 387 01.12.2005

1 Design – Flasche

Hinterleger: Mey Alkollü İçkiler Sanayii ve Ticaret Anonim Sirketi, Buyukdere Caddesi No: 71, Kat: 1 Maslak Sisli, Istanbul, TR

Designer: Gulay Gamze Guven, Istanbul; Mete Ahiska, Istanbul

Vertreter: A.W. Metz & Co. AG, 8024 Zürich

Priorität: TR, 15.07.2005

52419-CH-1-DA (siehe Farbteil Heftmitte)

Cl. 09-03 132 388 08.11.2005

1 Design – Schale

Hinterleger: Bischofszell Nahrungsmittel AG, Industriestrasse 1, 9220 Bischofszell

Designer: Dieter Veit, Altnau

Vertreter: Albiplast AG, 9244 Niederuzwil



AP-DS 25012-10

Cl. 10-02 132 389 27.09.2005

24 design – montres

Déposant: Festina Lotus S.A., Via Layetana, 20-4a, Barcelona, ES

Designer: Miguel Rodriguez, Barcelona

Mandataire: Griffes Consulting S.A., 1206 Genève

Priorité: EM, 01.04.2005



1



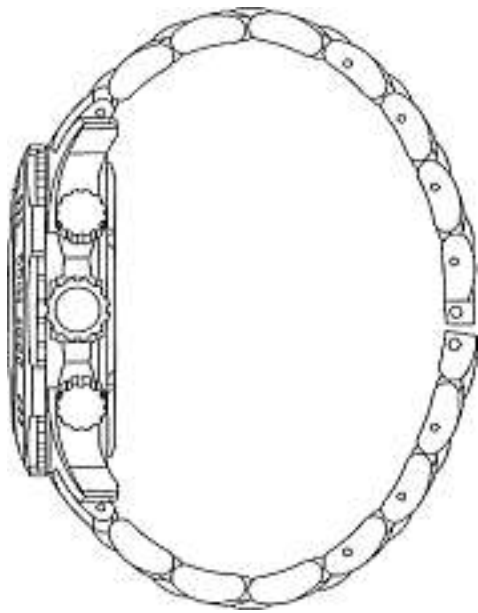

2



5

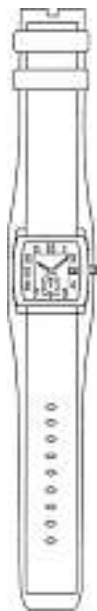

3



6



4



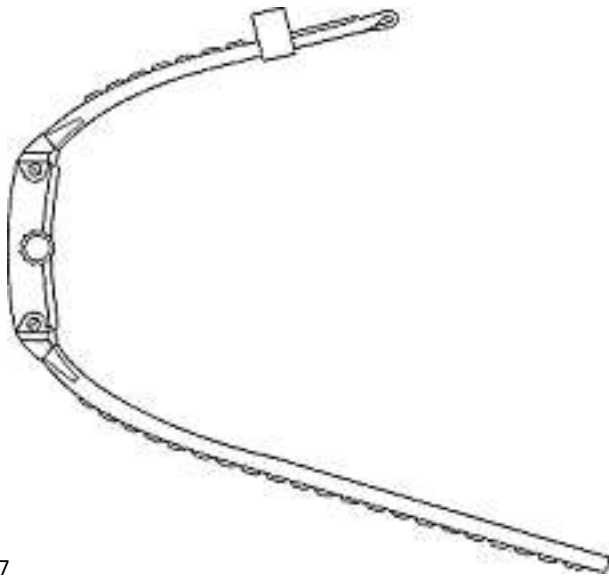

7



9



10

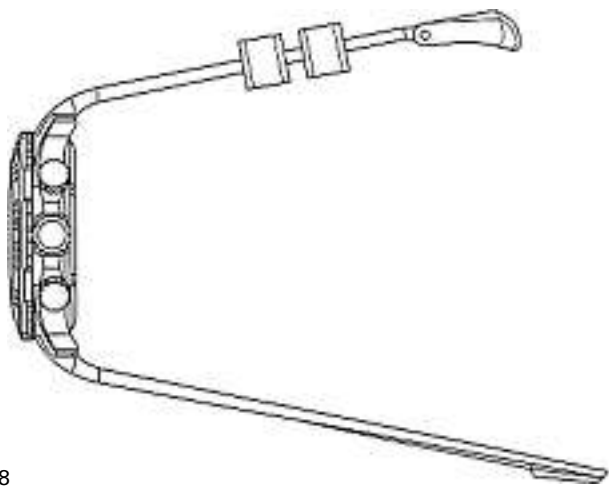

8



11



12

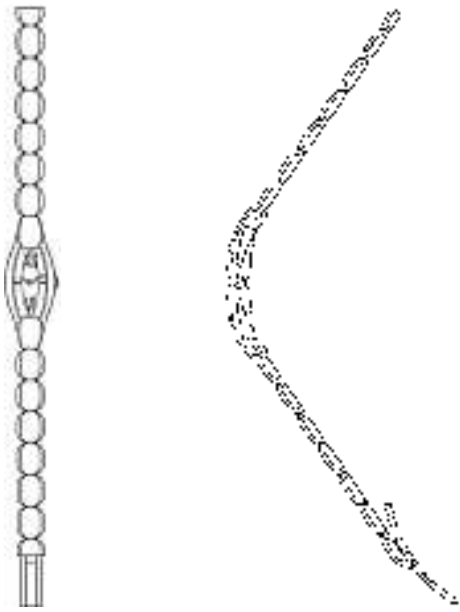

13

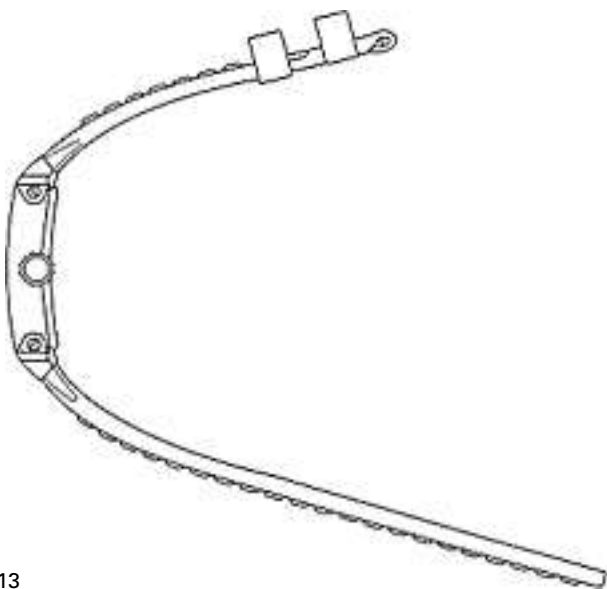

14

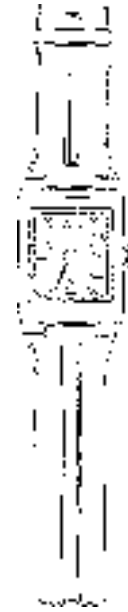

15

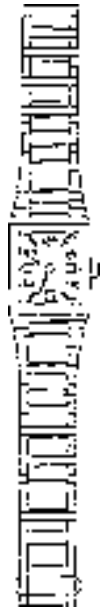

16

70

17



18

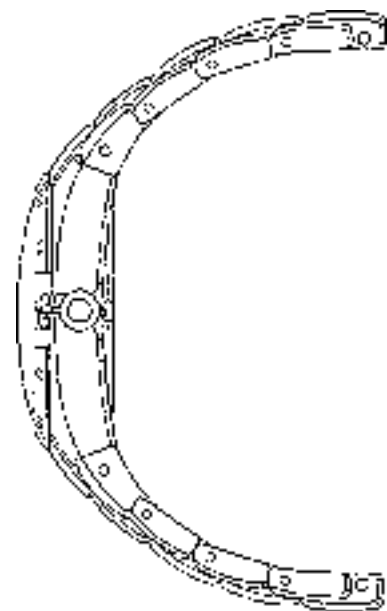
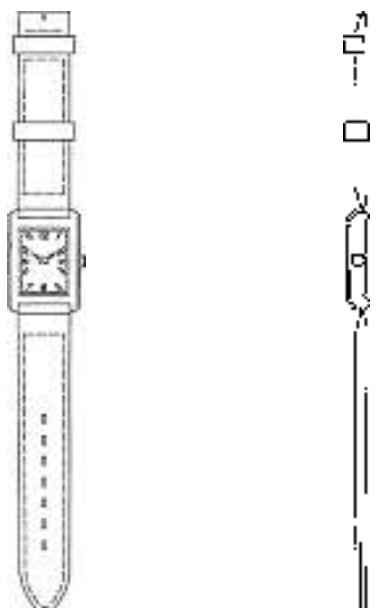

19

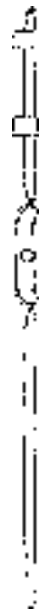

21



20



22



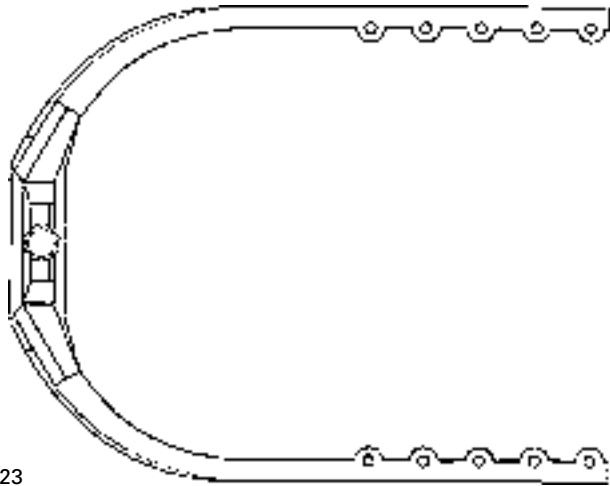

23



24

Cl. 10-07 132 390 31.10.2005
6 design – montre
Déposant: Walter Schlup, Av. Léopold-Robert 13, BP 1381,
2301 La Chaux-de-Fonds

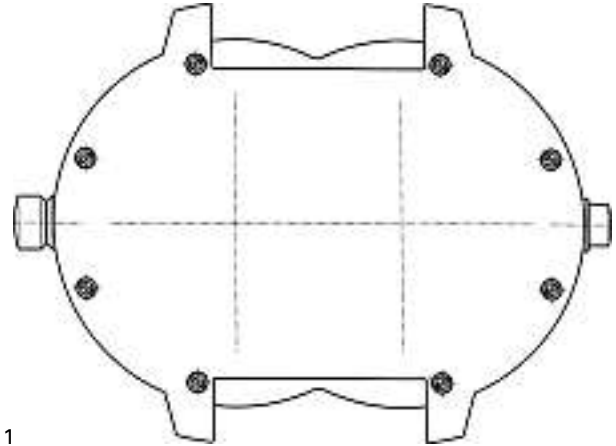
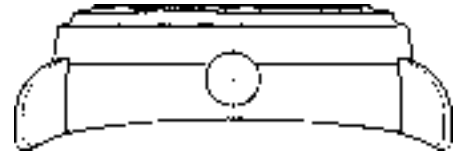
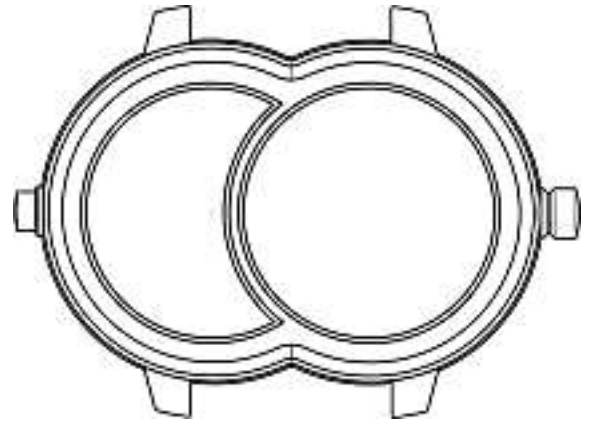

1

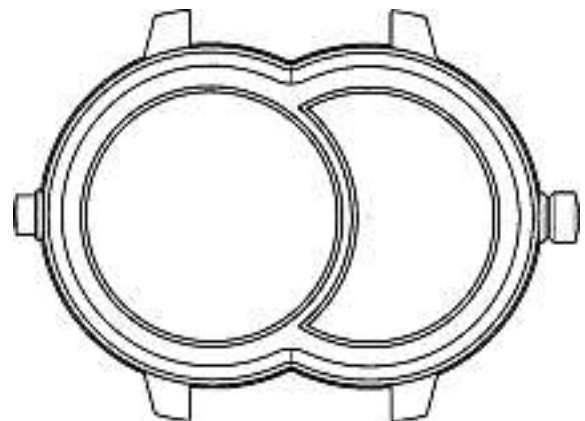

2

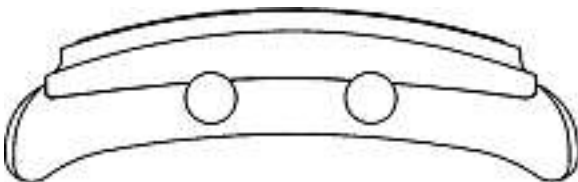
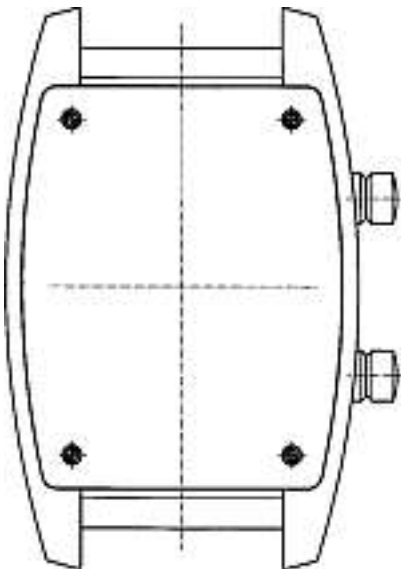
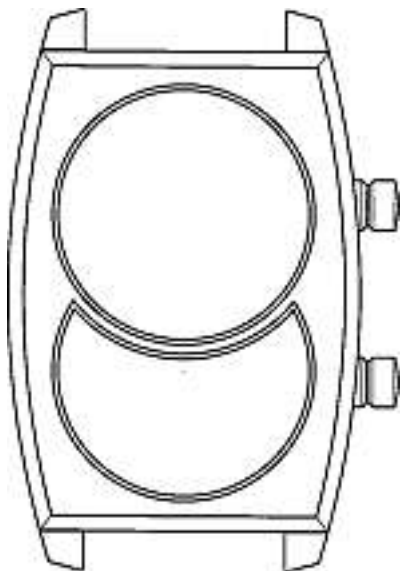

3



4

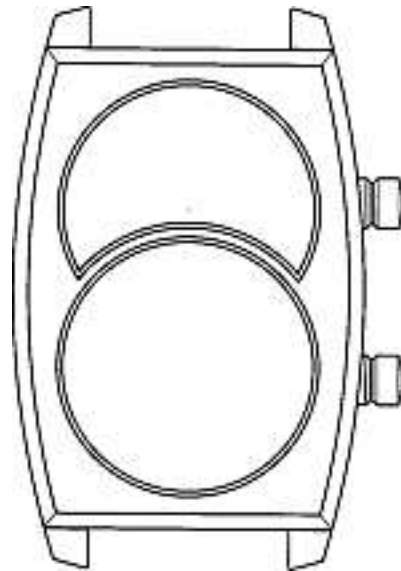

5

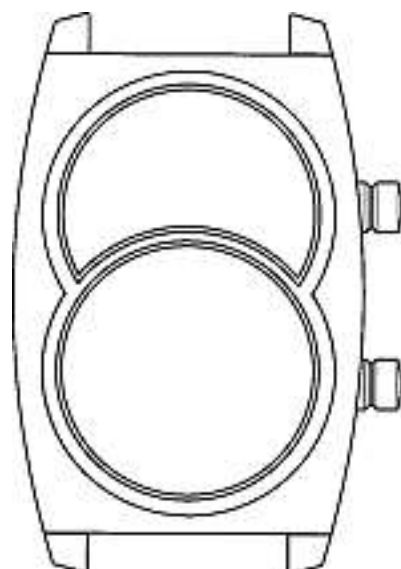

6

Cl. 12-05 132 391 30.11.2005

1 design – palan

Déposant: Kito Corporation, 2000, Tsuijijarai, Showa-cho,
Nakakoma-gun, Yamanashi, JPDesigner: Desheng Xia, Yamanashi; Koji Koyama,
Yamanashi; Michio Fukasawa, Yamanashi

Mandataire: Bugnion S.A., 1211 Genève 12 - Champel

Priorité: JP, 03.06.2005

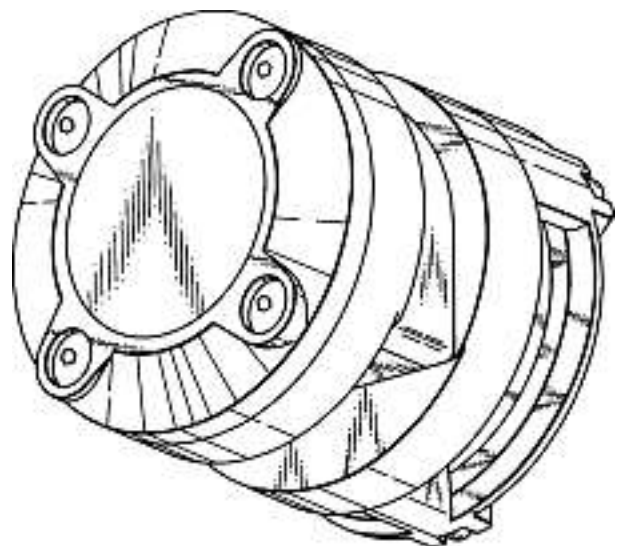

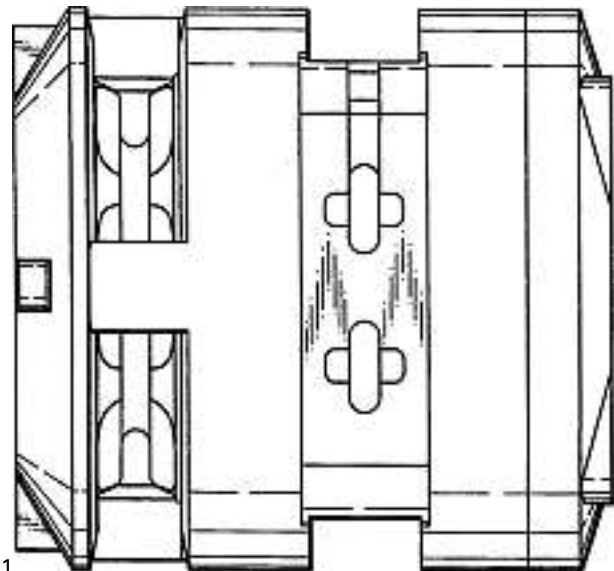
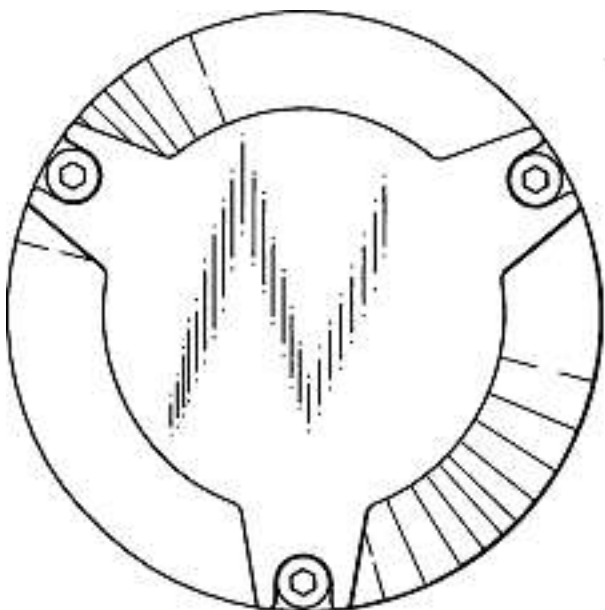
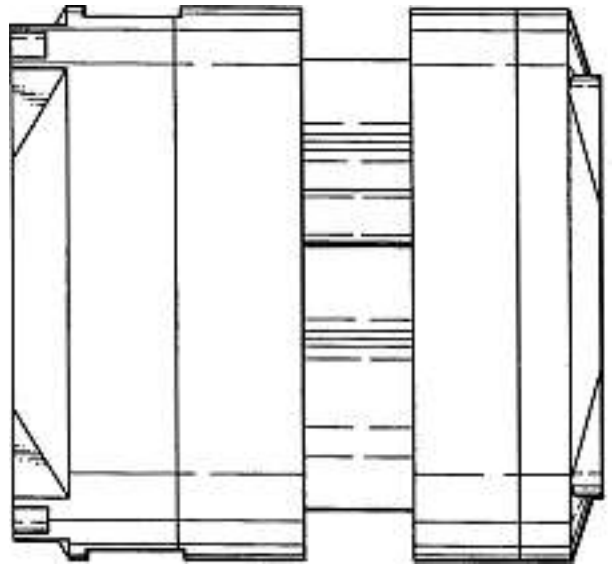
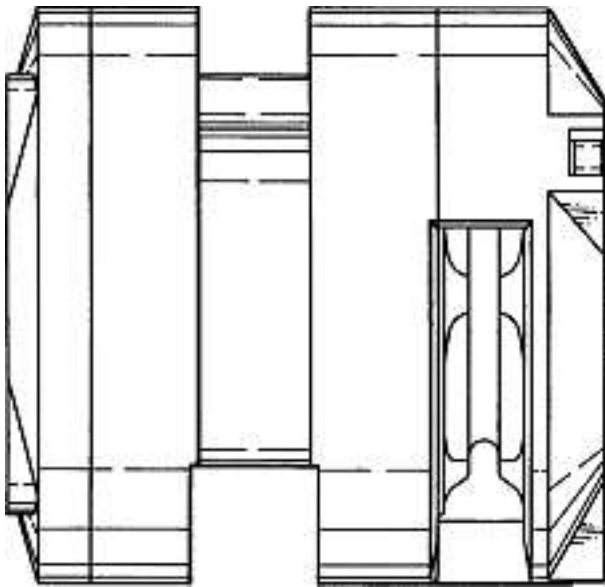
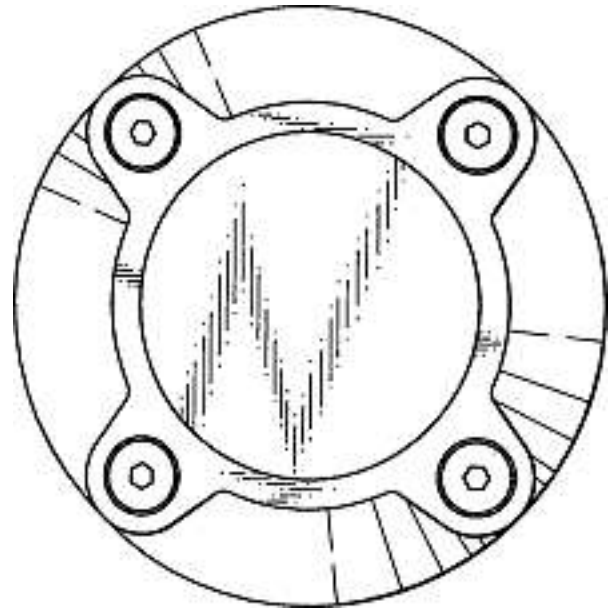
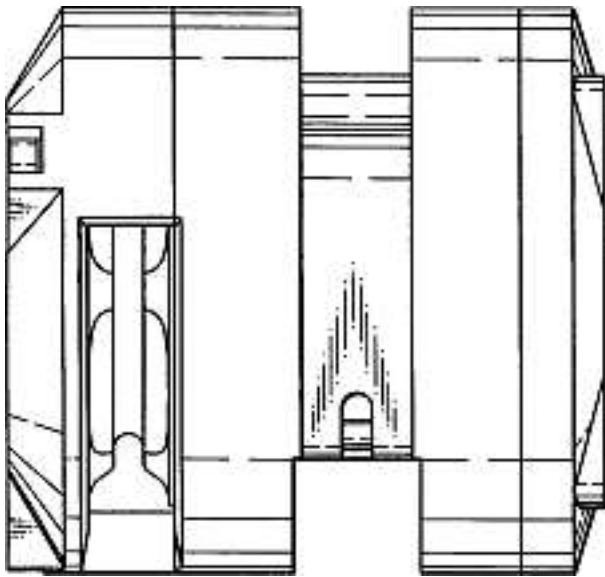

Cl. 12-05 132 392 05.12.2005
 1 design – palan
 Déposant: Kito Corporation, 2000, Tsuijiarai, Showa-cho,
 Nakakoma-gun, Yamanashi, JP
 Designer: Shinji Hagihara, Yamanashi; Fujito Yudate,
 Yamanashi
 Mandataire: Bugnion S.A., 1211 Genève 12 - Champel
 Priorité: JP, 09.06.2005

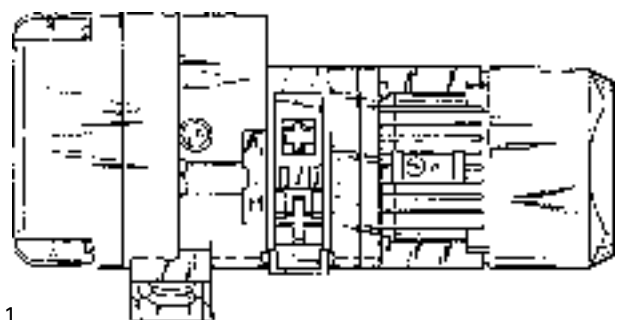
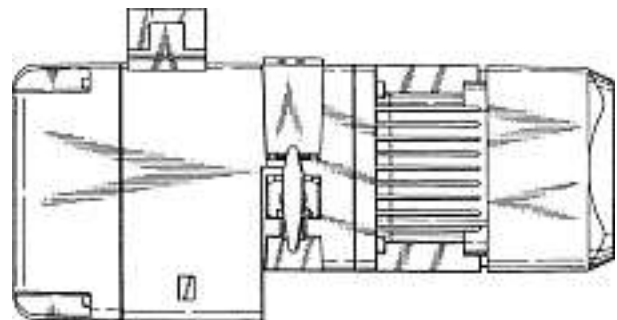
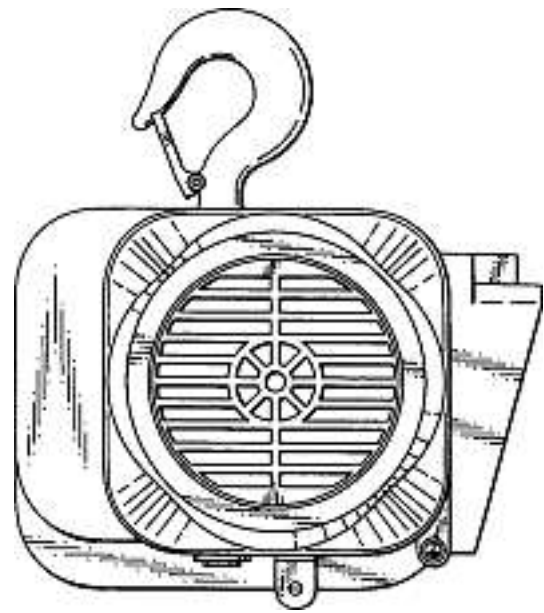
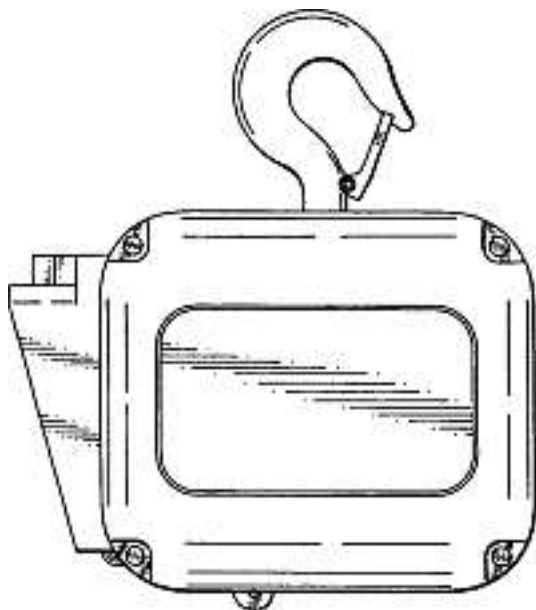
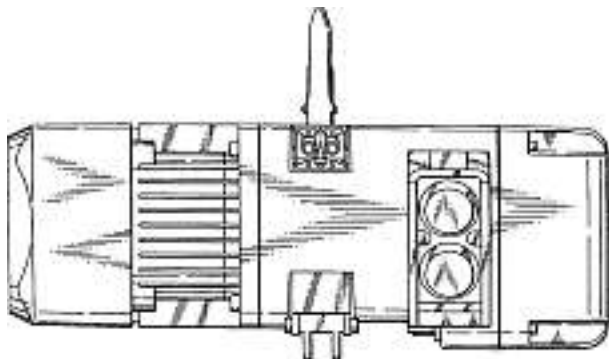
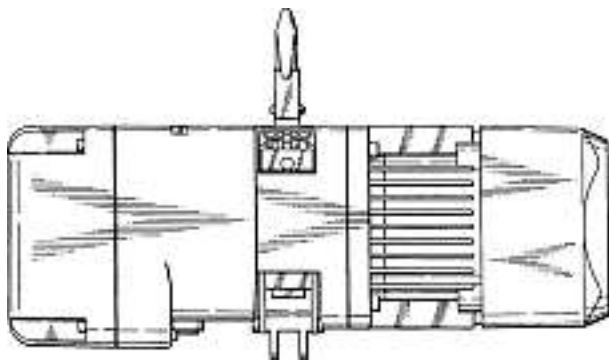
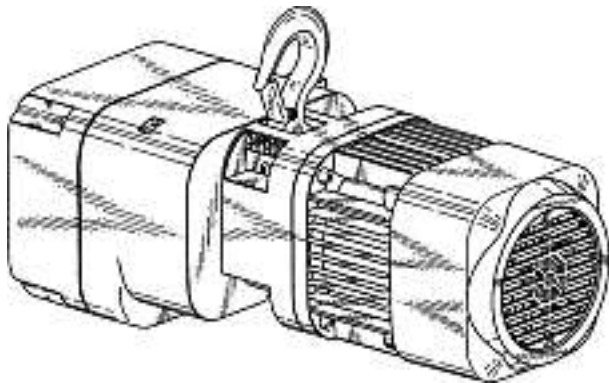

Cl. 12-15 132 393 05.12.2005
2 design – pneumatici per motociclette
Depositante: Pirelli Pneumatici S.p.A., Viale Sarca 222,
20126 Milano, IT
Designer: Gunter Steinbach, Milano
Mandatario: Fiammenghi-Fiammenghi, 6900 Lugano
Priorità: EM, 30.06.2005

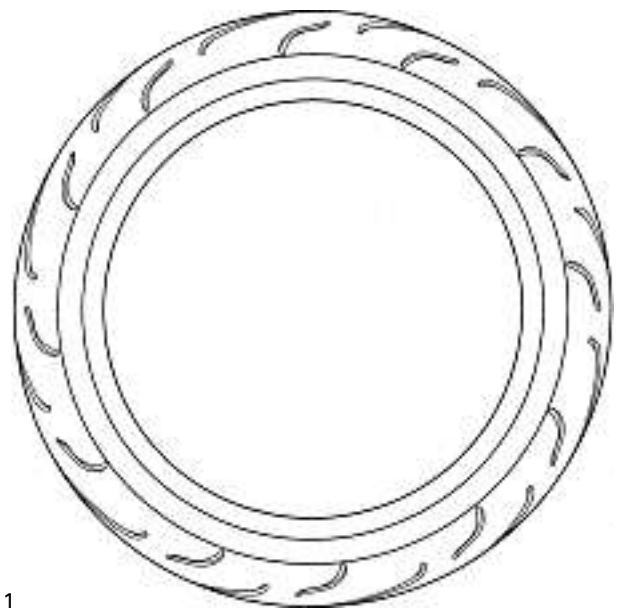
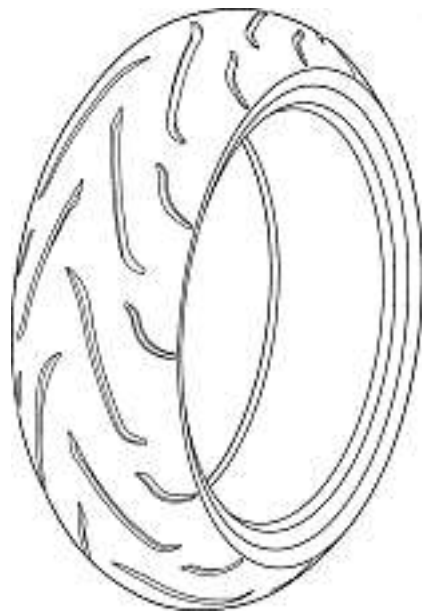

1



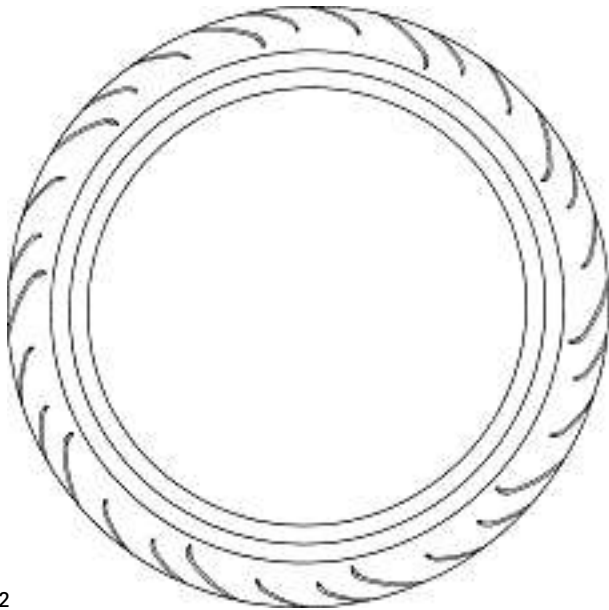

2

Cl. 13-02 **132 394** 13.12.2005

4 design – piles

Déposant: Hitachi Maxell, Ltd., 1-88, Ushitora 1-chome, Ibaraki-Shi (Osaka), JP

Designer: Takashi Kimura, Osaka; Ken-ichi Sano, Osaka

Mandataire: William Blanc & Cie, Conseils en Propriété Industrielle S.A., 1220 Les Avanchets/Genève

Priorité: JP 23.06.2005; JP 23.06.2005; JP 23.06.2005;

JP 23.06.2005

D-15843 CH-1

D-15843 CH-2

D-15843 CH-3

D-15843 CH-4 (siehe Farbteil Heftmitte)

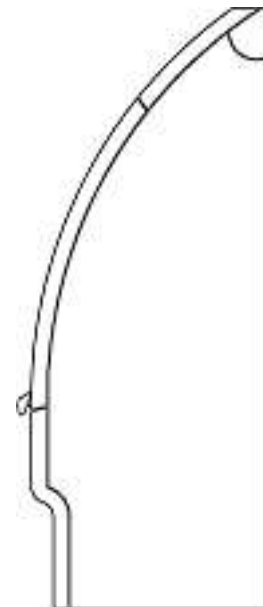
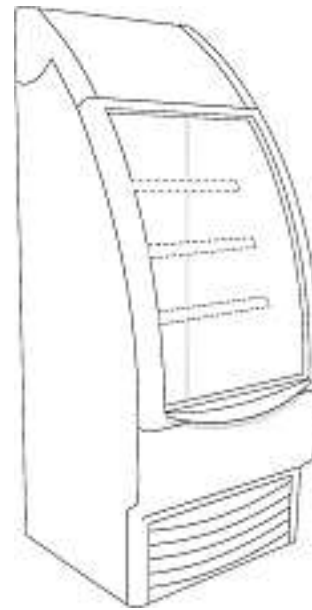
Cl. 15-07 **132 395** 16.12.2005

1 design – machines et appareils de réfrigération

Déposant: Société des Produits Nestlé SA, 1800 Vevey

Designer: Frank Rousselin, Voiron

Mandataire: Nestec S.A., 1800 Vevey

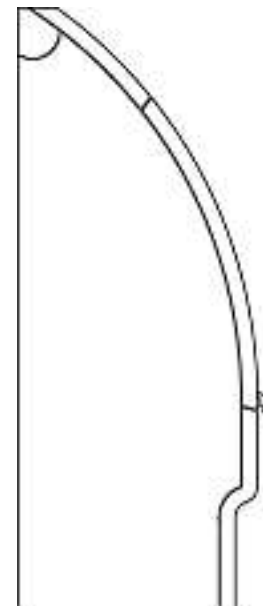
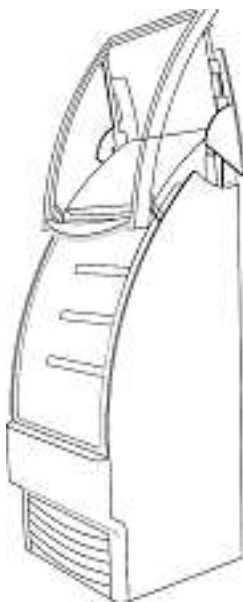

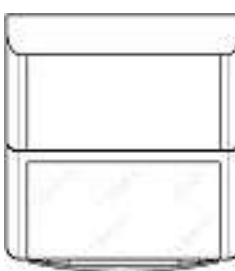
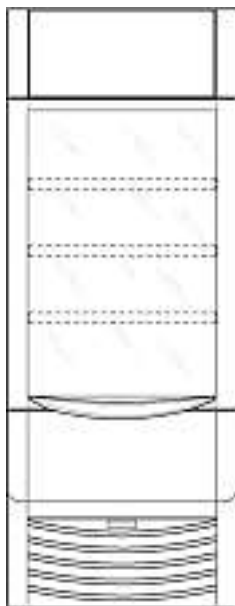

Cl. 19-06 **132 396** 02.12.2005
14 design – instruments pour l'écriture, crayons
Déposant: Volkmar Rommel, Am Strassdorfer Berg 1,
Schwäbisch Gmünd, DE
Mandataire: MICHELI & CIE SA, 1226 Thônex

1

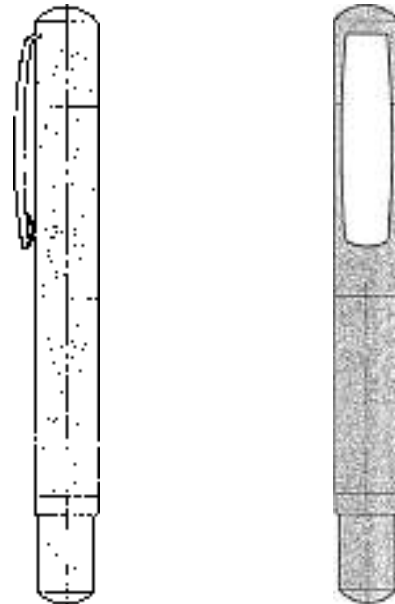

2

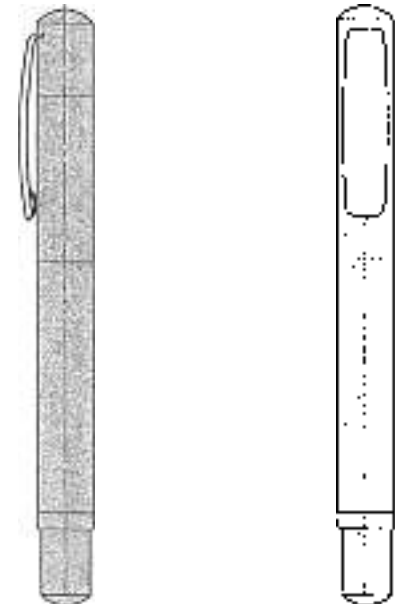

3

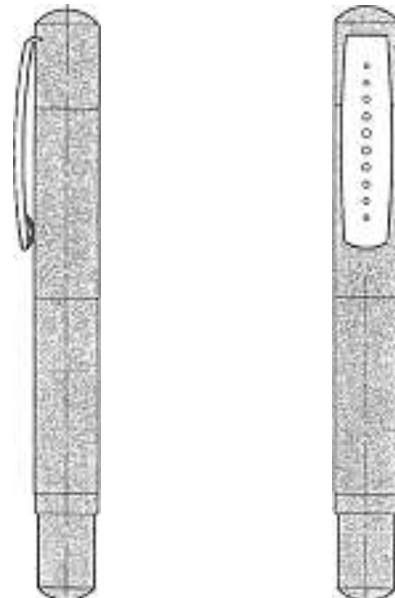

4

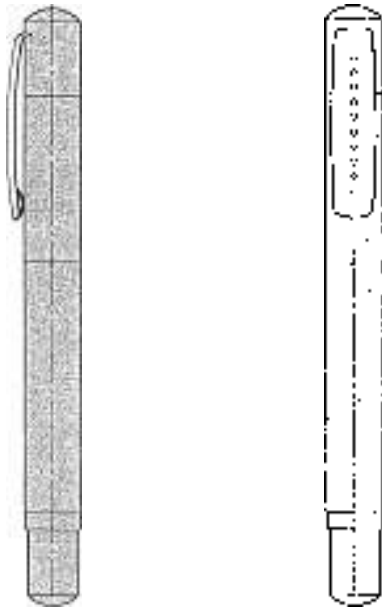

5

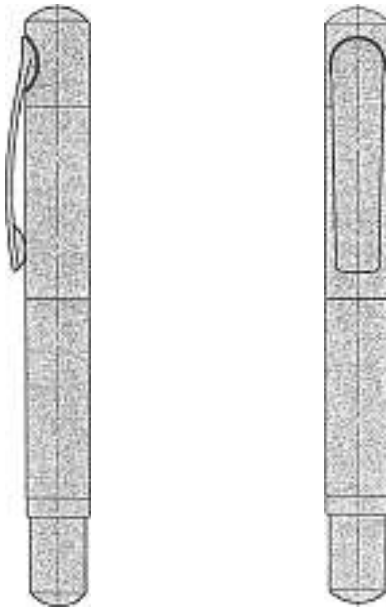

6

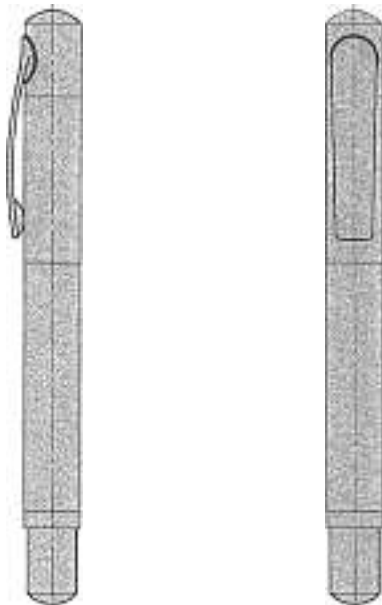

7

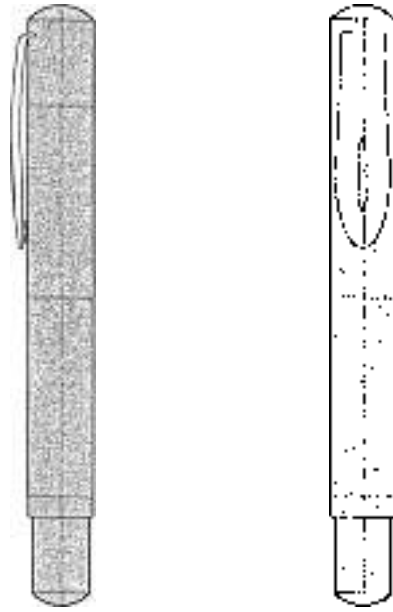

8

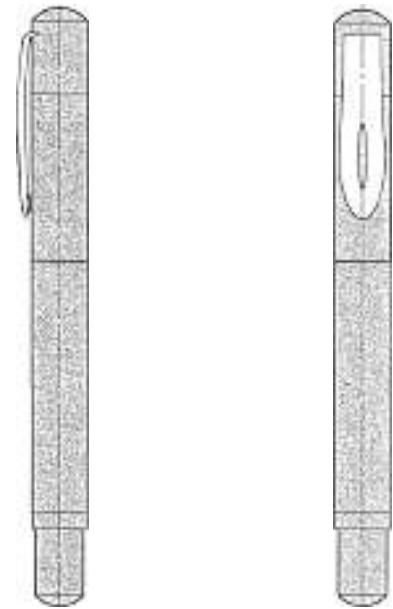

9

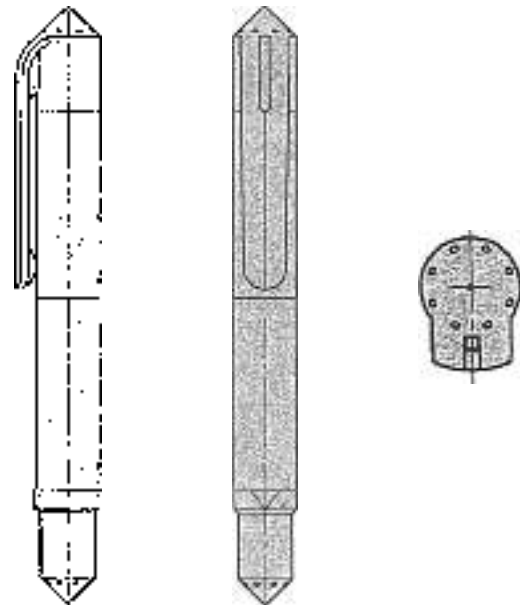

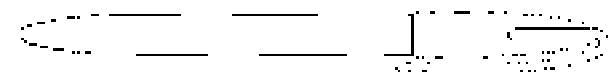
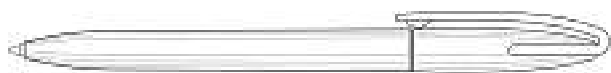

1

Cl. 19-08 132 398 07.12.2005

1 Design – Druckvorlage

Hinterleger: project-starfish gmbh,
Gen. Werdmüllerstrasse 14, 8804 Au ZH

Designer: Rosemarie Böttcher, Au ZH; Andreas Ott, Au ZH
1 (siehe Farbteil Heftmitte)

Cl. 19-08 132 399 08.12.2005

9 design – motifs de décoration

Déposant: Carolina Herrera Ltd, Société organisée selon les
lois de l'Etat du Delaware, 501 Seventh Avenue - 17th Floor,
New York/NY, US

Designer: Maria del Carmen Rodriguez Prieto, Barcelone

Mandataire: Cabinet GERMAIN & MAUREAU,

2028 Vaumarcus

Priorité: EM, 25.07.2005

1

2

3

4

5

6

7

8

9 (siehe Farbteil Heftmitte)

Cl. 21-01

132 401

15.11.2005

1 Design – Spiel

Hinterleger: Webcraft GmbH, Winterthurerstrasse 18 b,
8610 Uster

Designer: Matthias Ackermann, Uster

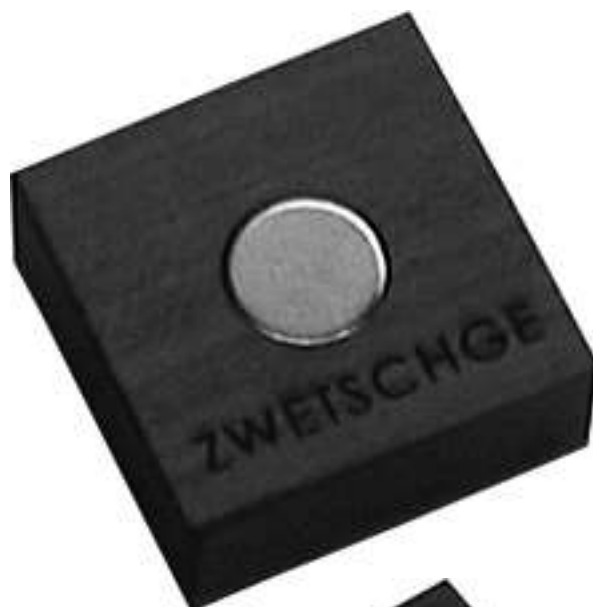

edu cut

Cl. 21-01 132 402 01.12.2005
6 design – roulettes
Depositante: HOMES for HOPE ONG, C/O Avv. Marco Villa,
Via Architetto da Ponte, 1, 6802 Ponte Capriasca
Designer: Alfredo Villa, Milano
Mandatario: Studio Rapisardi S.A., 6900 Lugano



1



3



4



2



5



6

Cl. 23-02 132 403 02.12.2005
 1 Design – Papierspender
 Hinterleger: SCA Hygiene Products AB, 405 03 Göteborg, SE
 Designer: Russell Wieser, Appleton; Wolfgang Ott, Antioch
 Vertreter: Bovard AG, 3000 Bern 25
 Priorität: US, 03.06.2005

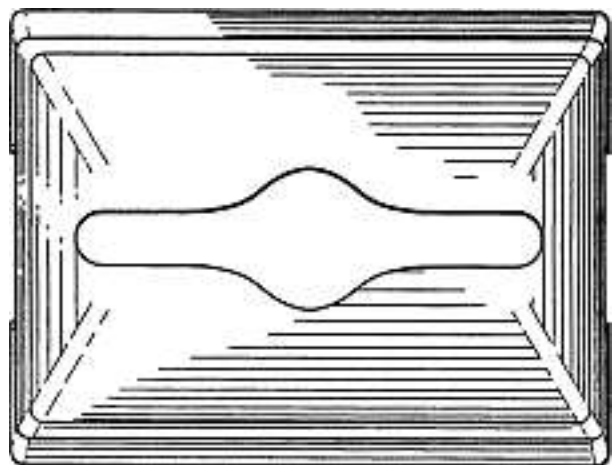
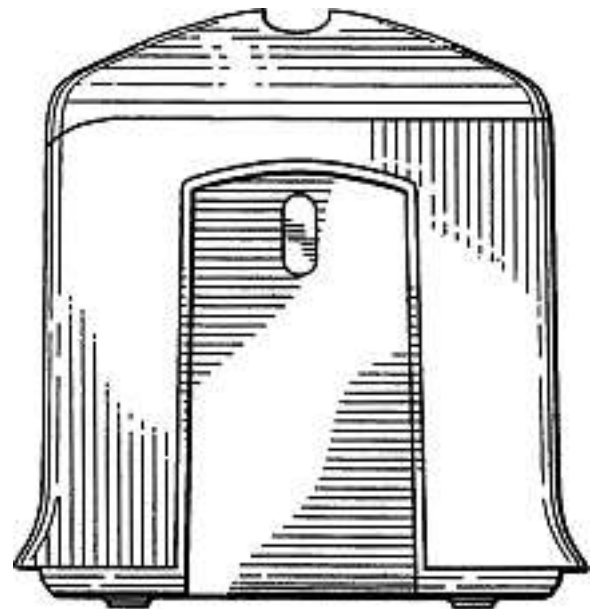
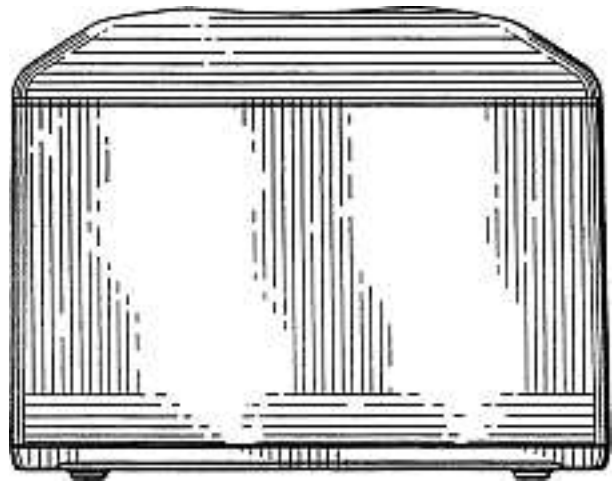
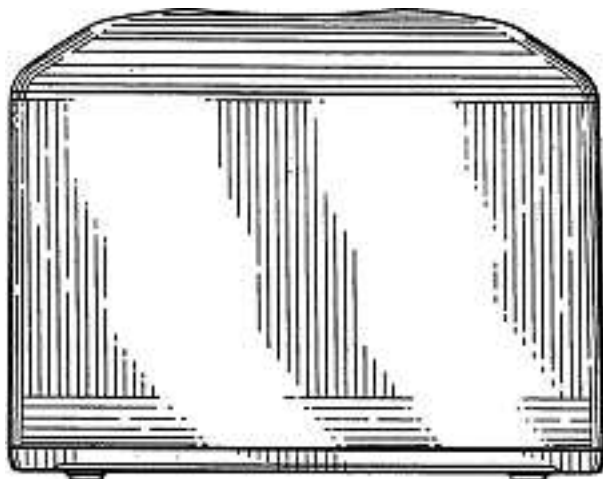
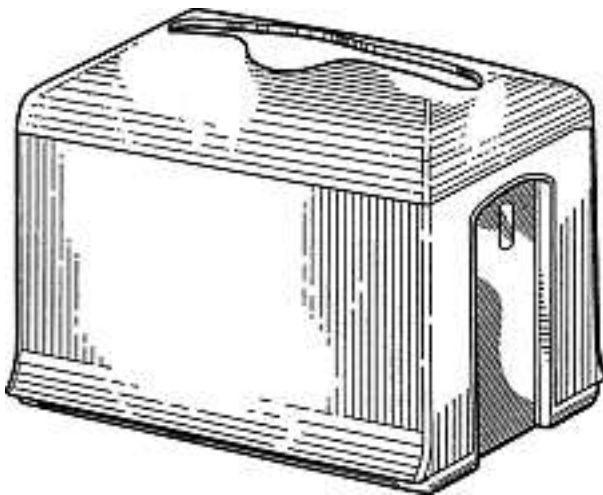

1

Cl. 25-01 **132 404** 02.12.2005
 4 design – pannelli per costruzioni
 Depositante: De Berg S.r.l., Via Carducci, 2, Milano, IT
 Designer: Silvano Regorda, Cusago
 Mandatario: Jacobacci & Partners S.A., 1207 Genève
 Priorità: EM, 08.06.2005

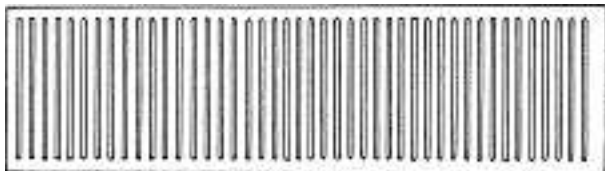
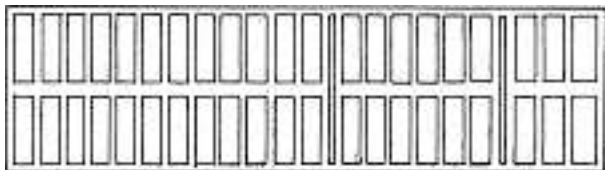

D-1989/05-S1

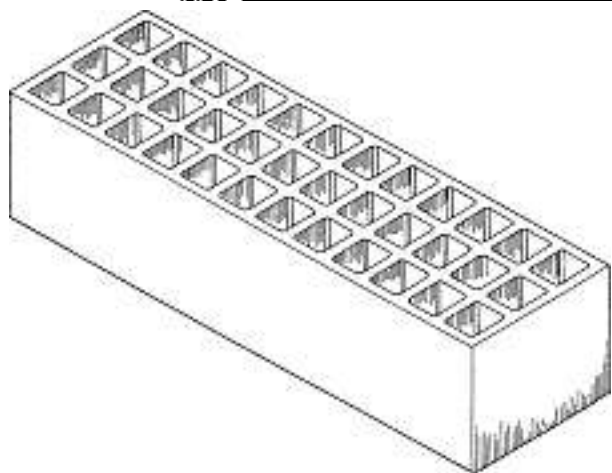

D-1989/05-S2

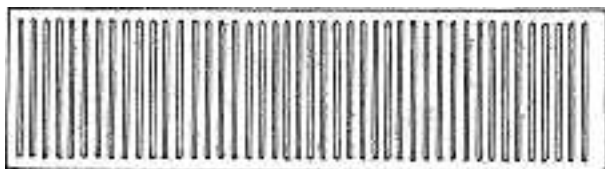
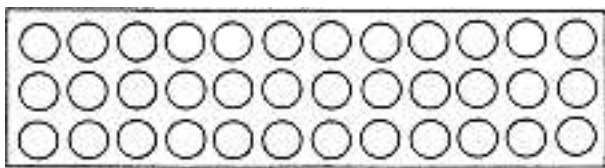

D-1989/05-S3

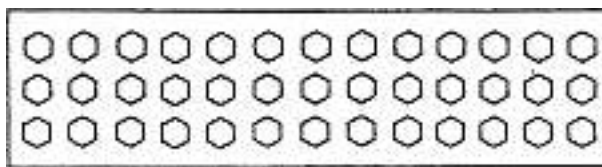

D-1989/05-S4

Cl. 25-02 **132 405** 01.12.2005
 3 Design – Zäune
 Hinterleger: Frank Hesselmann, Habsburger Strasse 8,
 Berlin, DE; Murat Kocyigit, Rotherstrasse 28, Berlin, DE
 Vertreter: Isler & Pedrazzini AG, 8023 Zürich
 Priorität: DE, 02.06.2005

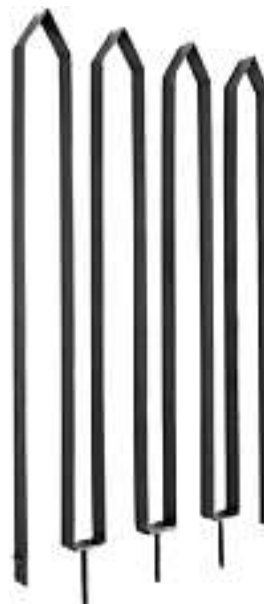
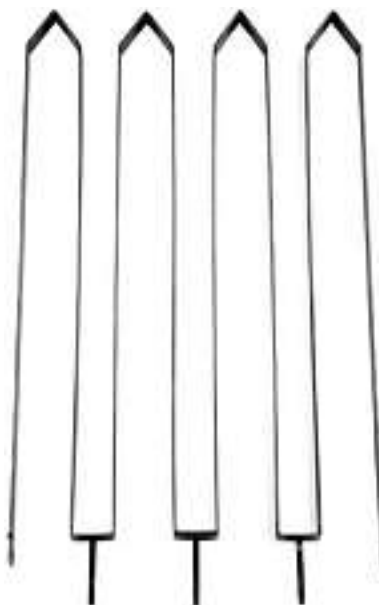

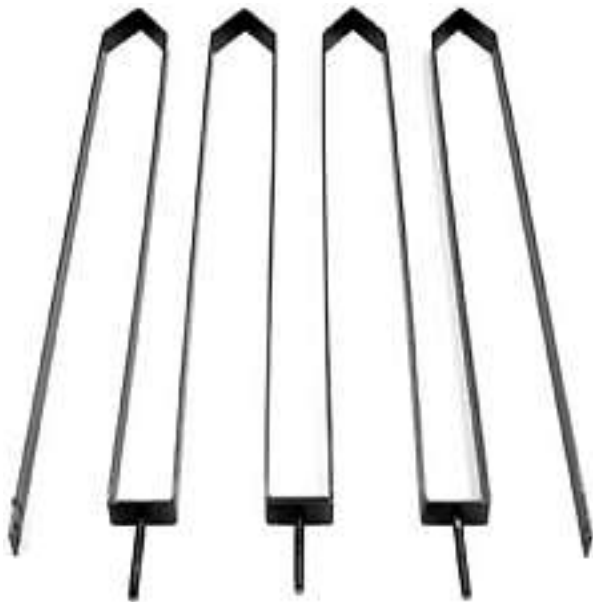
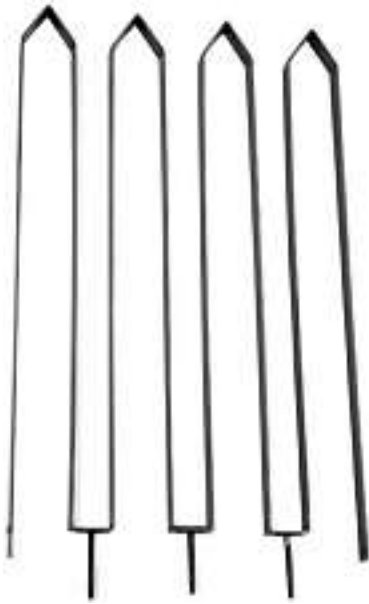

1

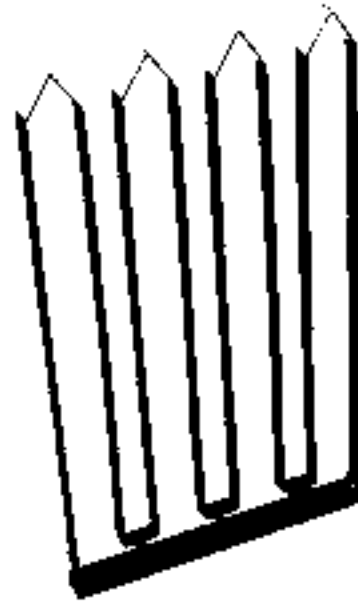



2

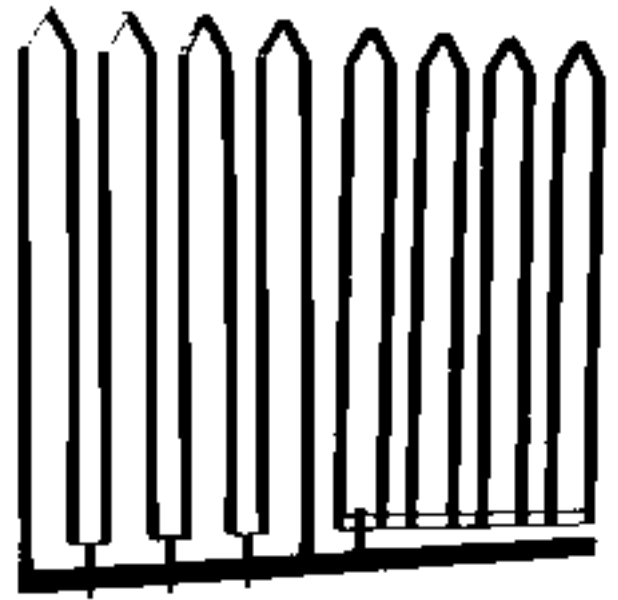
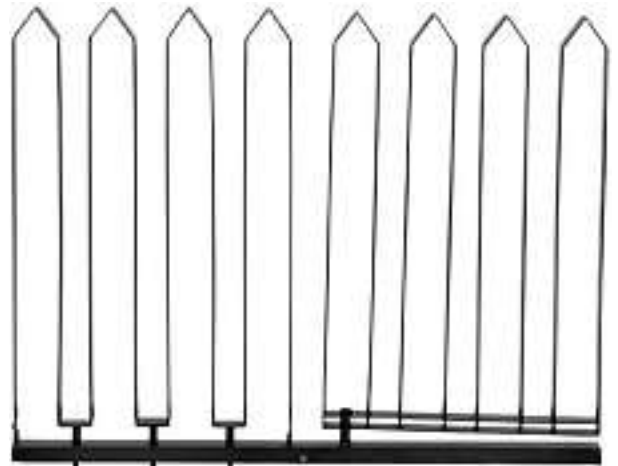

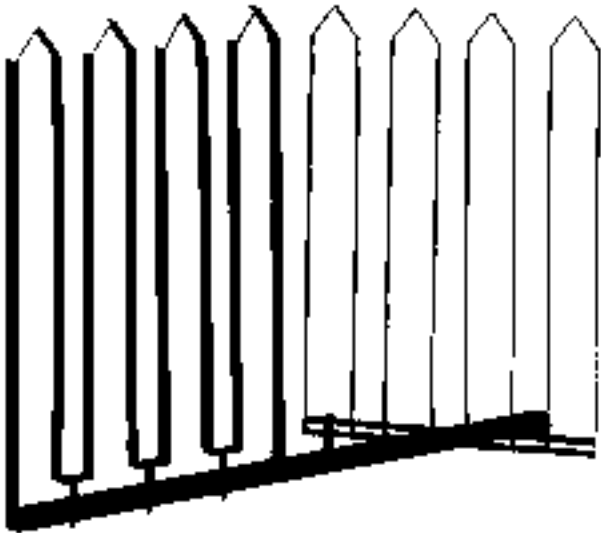
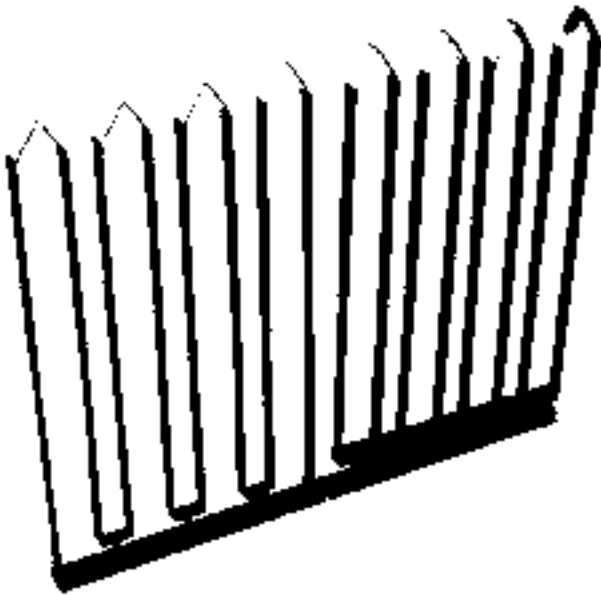

3

Cl. 28-03 **132 406** 05.12.2005

1 Design – Bräunungsgerät
 Hinterleger: JK-Holding GmbH, Köhlershohner Strasse,
 53578 Windhagen, DE
 Designer: Walter Kratz, Eitdorf
 Vertreter: Riederer Hasler & Partner Patentanwälte AG,
 7310 Bad Ragaz
 Priorität: EM, 07.06.2005
 1 (siehe Farbteil Heftmitte)

Cl. 31-00 **132 407** 02.12.2005

1 Design – Kaffeeautomat
 Hinterleger: Coffee Nation Limited, 3 Knaves Beech,
 Loudwater, High Wycombe / Bucks, GB
 Designer: Matt Tidman, Surrey; Ian Whately, London; Zoe
 Powell, Surrey; Dick Powell, West Sussex; Adrian Caroen,
 East Sussex
 Vertreter: Dr. R.C. Salgo + Partner Patentanwälte AG,
 8636 Wald ZH
 Priorität: EM, 06.06.2005



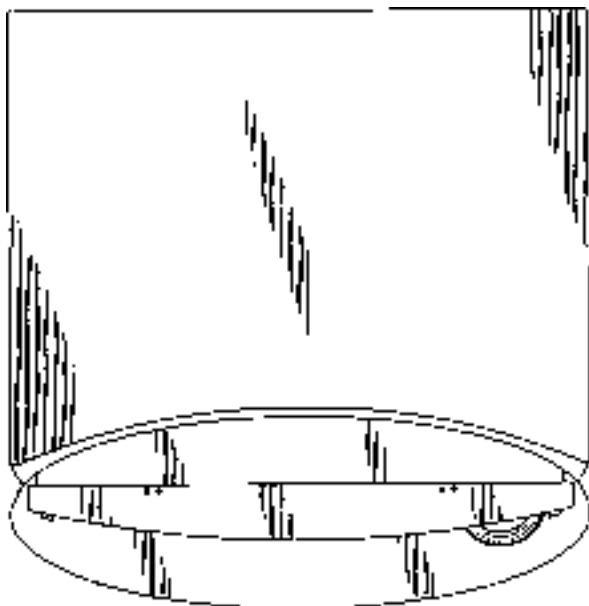
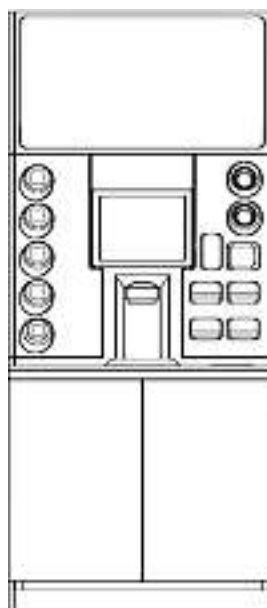
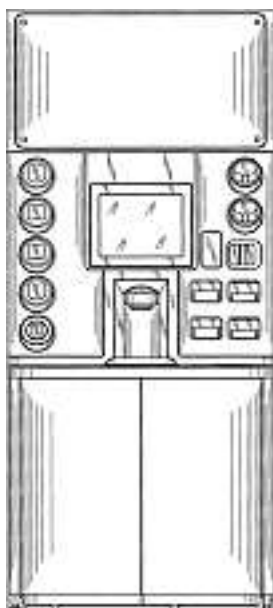

DBC-0401

Cl. 31-00 132 408 02.12.2005

1 Design – Kaffeeautomat

Hinterleger: Coffee Nation Limited, 3 Knaves Beech, Loudwater, High Wycombe / Bucks, GB

Designer: Matt Tidman, Surrey; Ian Whately, London; Zoe Powell, Surrey; Dick Powell, West Sussex; Adrian Caroen, East Sussex

Vertreter: Dr. R.C. Salgo + Partner Patentanwälte AG, 8636 Wald ZH

Priorität: EM, 06.06.2005

DBC-0402 (siehe Farbteil Heftmitte)

**Verlängerungen
Prolongations
Prolongazioni**

118 735 Cl. 28-01 1 Design

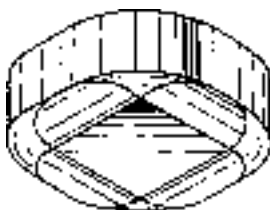
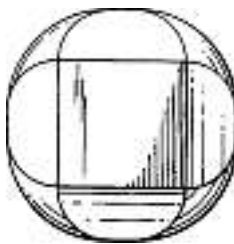
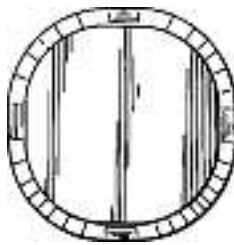
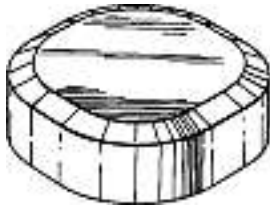

1

118 875 Cl. 19-02 2 design

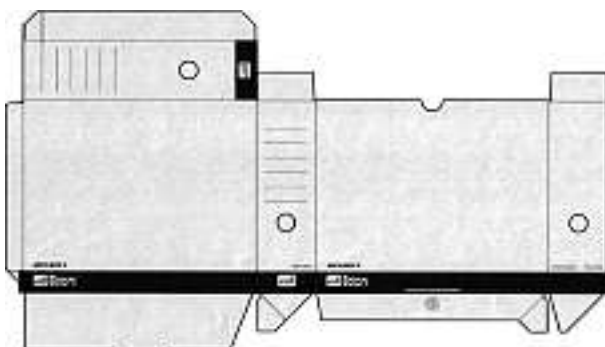

1

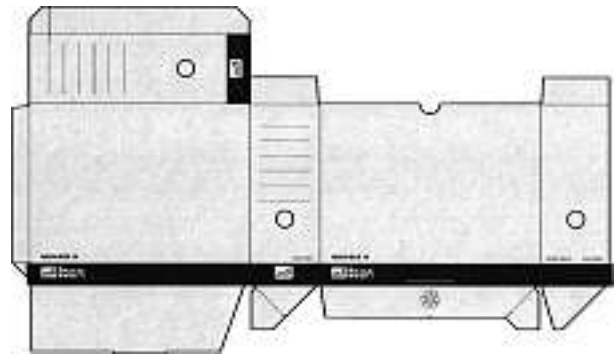

2

122 870	Cl.	07-01	3 design
122 945	Cl.	04-02	2 Design
122 954	Cl.	09-05	2 Design
122 956	Cl.	10-02	1 Design
122 982	Cl.	03-01	5 Design
123 057	Cl.	02-03	1 Design
123 109	Cl.	09-03	1 Design
123 110	Cl.	09-03	1 Design
123 114	Cl.	11-01	3 Design
123 245	Cl.	09-03	2 Design
127 495	Cl.	06-01	4 Design
127 593	Cl.	11-01	1 Design
127 608	Cl.	06-01	5 Design
127 634	Cl.	10-02	1 Design
127 637	Cl.	11-02	1 design
127 676	Cl.	08-05	1 Design
127 691	Cl.	25-01	1 Design
127 729	Cl.	25-01	2 Design
127 826	Cl.	06-01	60 Design
127 845	Cl.	12-11	1 Design
127 847	Cl.	12-11	1 Design
127 861	Cl.	31-00	1 Design
127 864	Cl.	03-01	1 Design
127 869	Cl.	06-03	1 Design

**Mutationen
Modifications
Modificazioni**

116 279
121 763
121 781
122 731
127 068
 Neuer Vertreter
 Vertreter: Beutler Künzi Stutz, Rechtsanwälte, 3000 Bern 6

118 735
 Neuer Vertreter
 Vertreter: Braunpat Braun Eder AG, 4054 Basel

122 982
 Übertragung
 Hinterleger: regroup ag, Grüngasse 21, 8004 Zürich
 Vertreter: Zimmerli, Wagner & Partner AG, 8001 Zürich

125 375
 Transmission
 Déposant: Richardson Sheffield Limited, Lion Works,
 60 Russell Street, Sheffield S3 8RW, GB
 Mandataire: Kirker & Cie S.A., Ingénieurs-Conseils,
 1226 Genève-Thônex

**Löschungen
Radiations
Radiazioni**

118 258	Cl.	09-01	1 Design
118 271	Cl.	14-03	1 Design
118 300	Cl.	09-03	2 Design
118 318	Cl.	18-01	1 Design
122 393	Cl.	06-01	1 Design
122 395	Cl.	07-99	1 Design
122 401	Cl.	07-99	1 Design
122 429	Cl.	02-07	1 Design
122 455	Cl.	15-09	1 design
127 050	Cl.	06-06	1 design
127 061	Cl.	10-02	1 Design
127 067	Cl.	14-02	1 design
127 082	Cl.	19-06	1 design
127 092	Cl.	25-04	1 Design
127 096	Cl.	03-01	20 Design
127 101	Cl.	06-01	2 Design
127 102	Cl.	06-01	2 Design
127 104	Cl.	06-01	71 Design
127 105	Cl.	06-01	2 Design
127 106	Cl.	06-01	1 Design
127 107	Cl.	06-04	2 Design
127 108	Cl.	06-04	1 Design
127 110	Cl.	06-04	1 Design
127 111	Cl.	06-05	1 design
127 113	Cl.	07-01	5 Design
127 114	Cl.	07-01	2 Design
127 120	Cl.	11-01	1 Design
127 122	Cl.	12-11	1 Design
127 124	Cl.	16-05	1 Design
127 127	Cl.	19-08	6 Design
127 128	Cl.	20-03	1 Design
127 133	Cl.	26-05	1 Design
127 134	Cl.	26-05	2 Design
127 262	Cl.	14-01	1 Design

Cl. 09-01

132 387

01.12.2005





52419-CH-1-DA

Cl. 13-02

132 394

13.12.2005

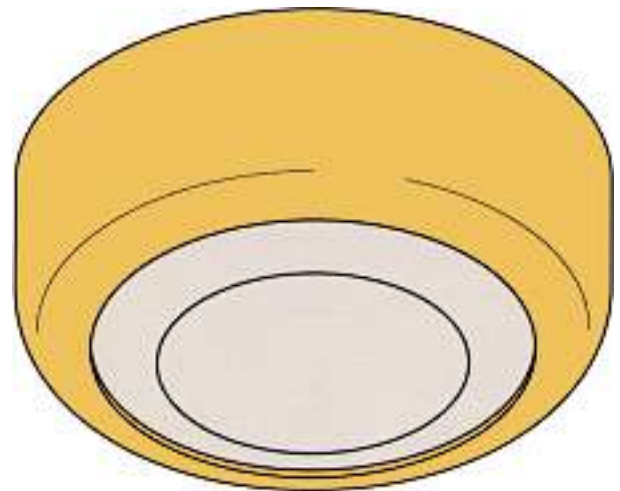
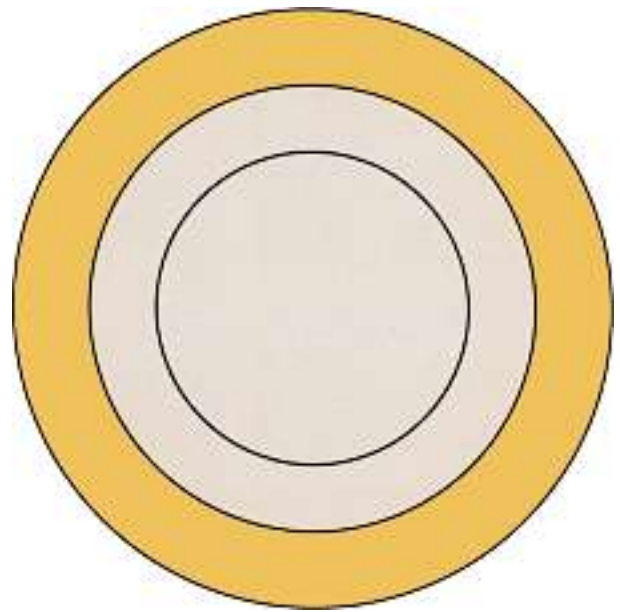

D-15843 CH-1



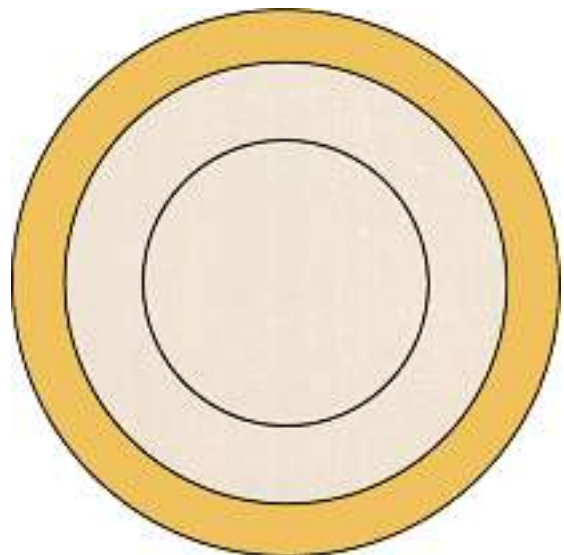
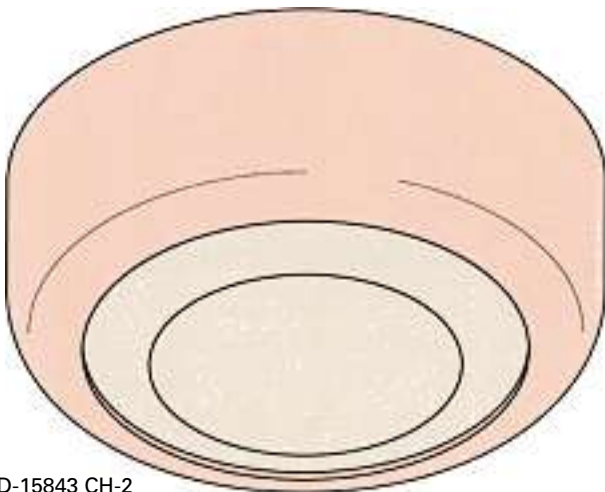
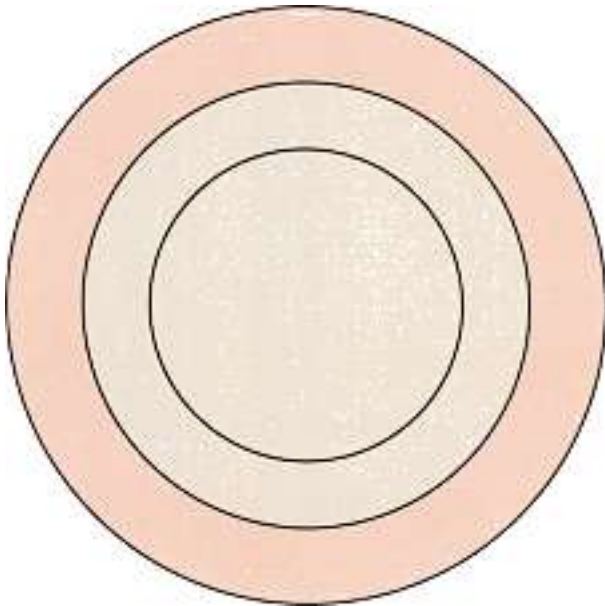
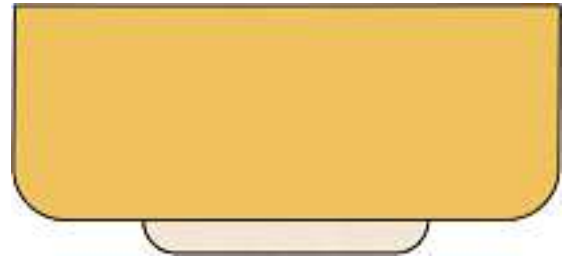
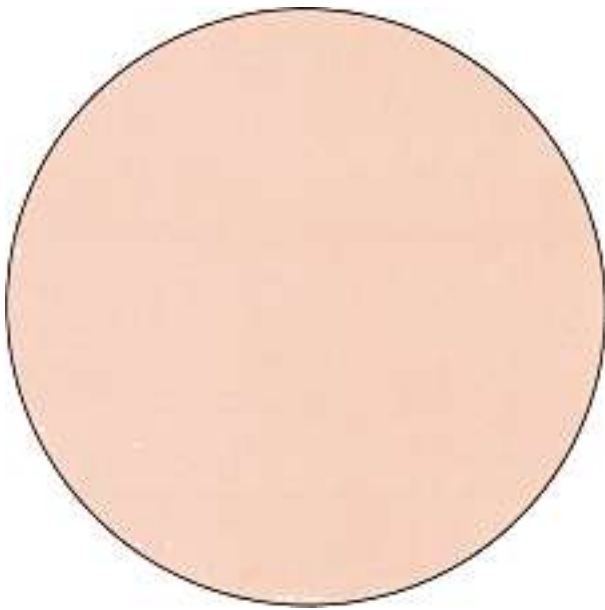

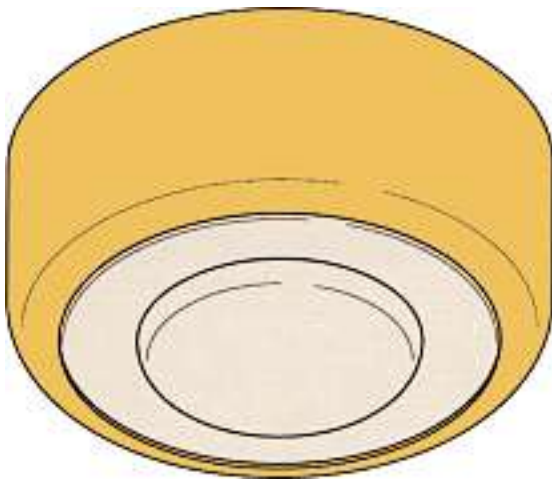

D-15843 CH-3

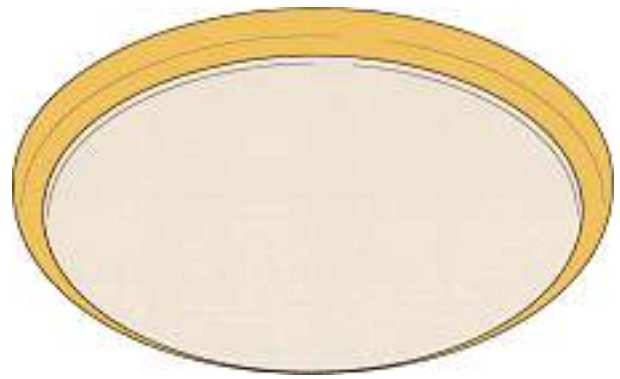

D-15843 CH-4

Cl. 19-08

132 398

07.12.2005



1

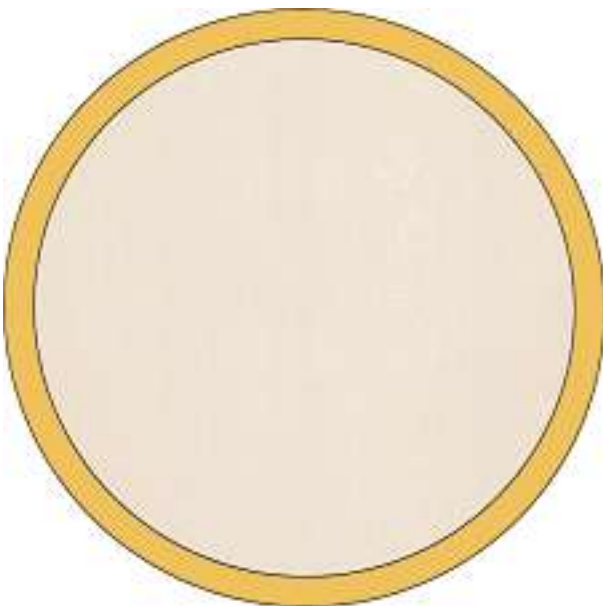

Cl. 19-08

132 399

08.12.2005



1

2



6



3



7



4



8



5



9



Cl. 28-03

132 406

05.12.2005

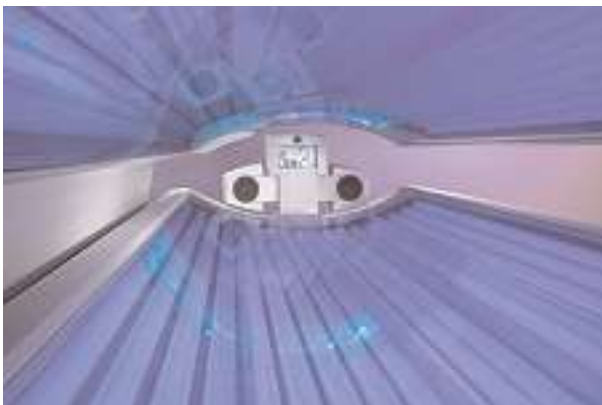

1

Cl. 31-00

132 408

02.12.2005



DBC-0402