

Nationale Hinterlegungen

In der folgenden Liste werden die beim Eidgenössischen Institut für Geistiges Eigentum hinterlegten Designs publiziert. Dabei sind der Reihe nach angegeben:

- internationale Klassenangaben
- Hinterlegungsnummer
- Hinterlegungsdatum
- Allenfalls Aufschub der Veröffentlichung
- Anzahl der hinterlegten Designs
- Bezeichnung
- Name und Wohnsitz des Hinterlegers oder der Hinterlegerin
- gegebenenfalls Name und Wohnsitz des Designers oder der Designerin
- Name und Geschäftssitz des allfälligen Vertreters oder der Vertreterin
- gegebenenfalls Prioritätsangaben
- gegebenenfalls Beschreibungstext
- Ordnungsnummer
- Reproduktion des Designs

Internationale Hinterlegungen

Die bei der Weltorganisation für geistiges Eigentum in Genf hinterlegten Muster und Modelle mit Benennung Schweiz geniessen den gleichen Schutz wie national hinterlegte Designs. Sie werden jeweils im Blatt «Bulletin des dessins et modèles internationaux» veröffentlicht. Dieses Publikationsorgan ist deshalb für eine vollständige Recherche unbedingt beizuziehen.

Topographien

Angaben über die vom Eidgenössischen Institut für Geistiges Eigentum eingetragenen Topographien von Halbleitererzeugnissen werden in folgender Anordnung aufgeführt:

- Eintragsnummer
- Anmeldedatum
- Bezeichnung
- Name und Wohnsitz des Anmelders oder der Anmelderin
- gegebenenfalls Name und Wohnsitz des Herstellers oder der Herstellerin
- Name und Geschäftssitz des oder der allfälligen Bevollmächtigten
- Datum und Ort einer allfälligen ersten geschäftlichen Verbreitung der Topographie

Dépôts nationaux

Les designs déposés à l'Institut Fédéral de la Propriété Intellectuelle sont publiés dans la liste qui suit. Les indications y relatives sont mentionnées dans cet ordre:

- indications des classes internationales
- numéro de dépôt
- date de dépôt
- le cas échéant, ajournement de la publication
- nombre des designs déposés
- désignation
- nom et domicile du/de la déposant/e
- le cas échéant, nom et domicile du/de la designer
- nom et domicile de l'éventuel/le mandataire
- le cas échéant, indication de priorité
- le cas échéant, description du design
- numéro attribué à chaque design
- reproduction du design

Dépôts internationaux

Les dessins et modèles déposés à l'Organisation Mondiale de la Propriété Intellectuelle à Genève qui désignent la Suisse jouissent de la même protection que les dépôts nationaux. Ils sont chaque fois publiés dans la feuille «Bulletin des dessins et modèles internationaux». Pour une recherche complète, il est indispensable de consulter ledit organe de publication.

Topographies

Les indications concernant les topographies des produits semi-conducteurs, enregistrées par l'Institut Fédéral de la Propriété Intellectuelle, sont énumérées dans l'ordre suivant:

- numéro d'enregistrement
- date de dépôt
- désignation
- nom et domicile du/de la déposant/e
- le cas échéant, nom et domicile du/de la producteur/trice
- nom et domicile de l'éventuel/le mandataire
- date et lieu d'une éventuelle première mise en circulation de la topographie

Depositi nazionali

Nella lista seguente vengono pubblicati i design depositati presso l'Istituto Federale della Proprietà Intellettuale. Sono menzionati nel seguente ordine:

- indicazioni delle classi internazionali
- numero di deposito
- data del deposito
- se del caso, indicazione che la pubblicazione è stata differita
- numero dei design depositati
- designazione
- nome e domicilio del depositante
- se del caso, nome e domicilio del designer
- nome e sede di un eventuale mandataro
- se del caso, indicazioni di priorità
- se del caso, descrizione del design
- numero d'ordine
- riproduzione del design

Depositi internazionali

I disegni e modelli depositati presso l'Organizzazione Mondiale della Proprietà Intellettuale a Ginevra con denominazione Svizzera godono della medesima protezione del deposito nazionale. Essi vengono pubblicati ogni volta nel foglio «Bulletin des dessins et modèles internationaux». Quest'organo di pubblicazione è da consultare se si vuole effettuare una ricerca completa.

Topografie

Le indicazioni concernenti le topografie di prodotti a semiconduttori depositati presso l'Istituto Federale della Proprietà Intellettuale sono menzionate nell'ordine seguente:

- numero di registrazione
- data del deposito
- designazione
- nome e domicilio del/la richiedente
- se del caso, nome e domicilio del/la produttore/trice
- nome e sede di un eventuale mandataro
- data e luogo di un'eventuale prima messa in circolazione della topografia

Hinterlegungen
Dépôts
Depositi

Cl. 11-01 **131 766** 04.05.2005
9 design – colliers, boucles d'oreilles
Déposant: Ludovic Lesemann Genève Sàrl., Avenue Krieg 7,
1208 Genève
Designer: Ludovic Lesemann, Genève
Mandataire: Griffes Consulting S.A., 1206 Genève
Fin de la période ajournement de la publication



1



3



2



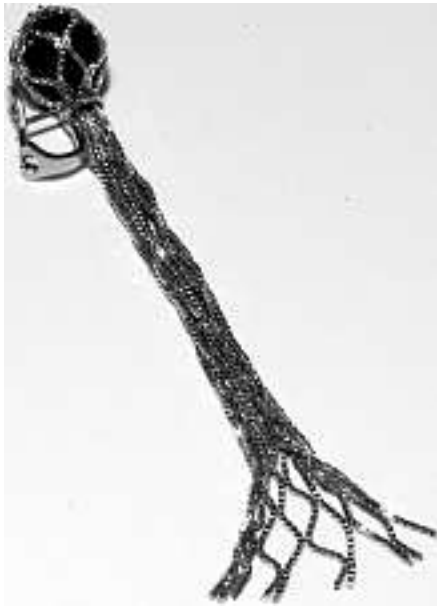

4



7



5



8



6



9

Cl. 02-07 134 430 17.10.2007
 2 design – tire-fermeture à glissière, boucle de ceinture
 Déposant: JM WESTON, Rue Nicolas Appert, Zone Industrielle Nord, Limoges, FR
 Designer: Jean-Christopher Descours, Limoges
 Mandataire: Griffes Consulting S.A., 1206 Genève
 Priorité: FR, 19.04.2007

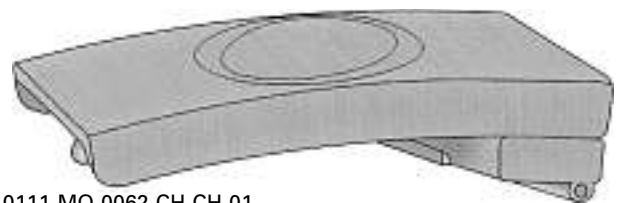

0111-MO-0062-CH-CH-01

Cl. 02-07 134 431 17.10.2007
 2 design – passant, pontet
 Déposant: JM WESTON, Rue Nicolas Appert, Zone Industrielle Nord, Limoges, FR
 Designer: Jean-Christopher Descours, Limoges
 Mandataire: Griffes Consulting S.A., 1206 Genève
 Priorité: FR, 19.04.2007

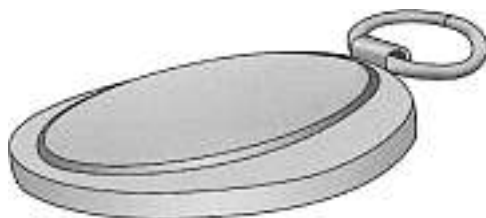

0111-MO-0061-CH-CH-01

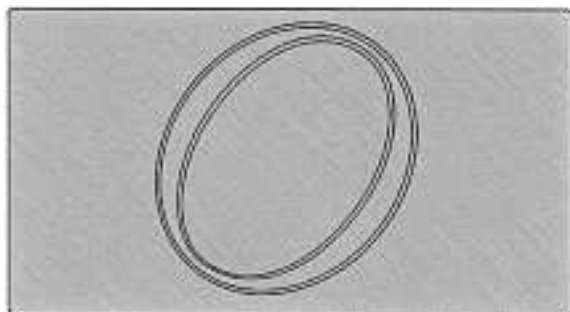

0111-MO-0063-CH-CH-01

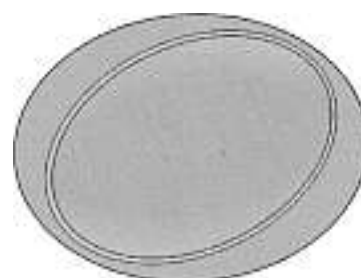

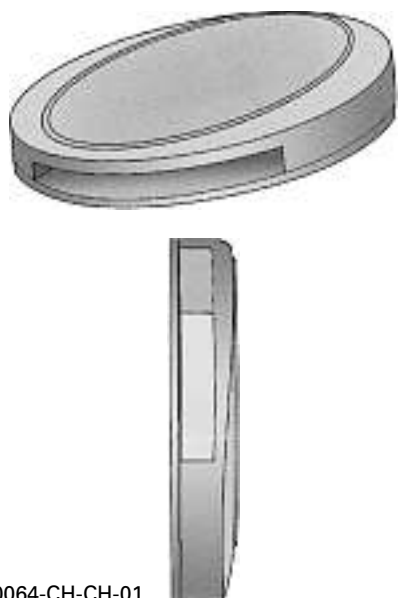

0111-MO-0064-CH-CH-01

Cl. 06-01 134 432 03.10.2007

1 design – sedia

Depositante: Armet S.p.A., Via Campo Aviazione 4, Casoni di Mussolente (Vicenza), IT

Designer: Giovanni Ferronato, Casoni di Mussolente

Mandatario: Jacobacci & Partners S.A., 1207 Genève

Priorità: EM, 12.04.2007

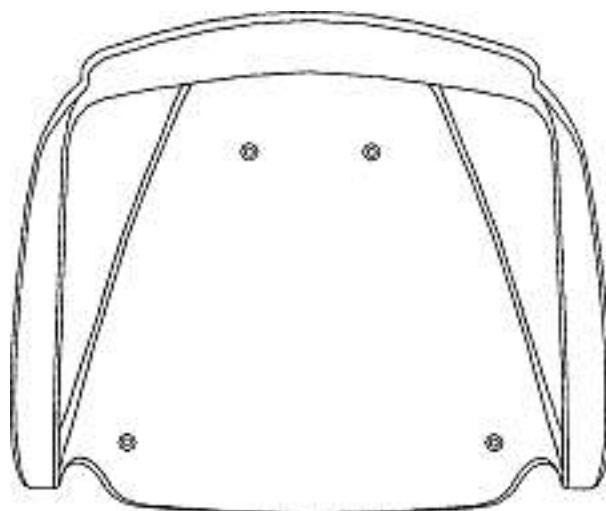
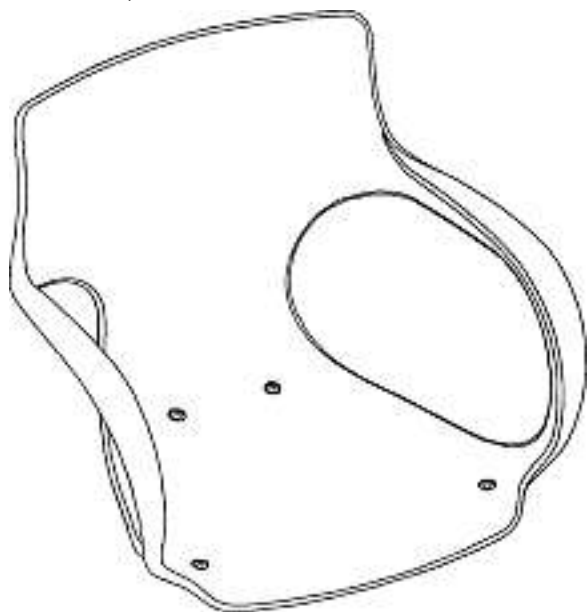
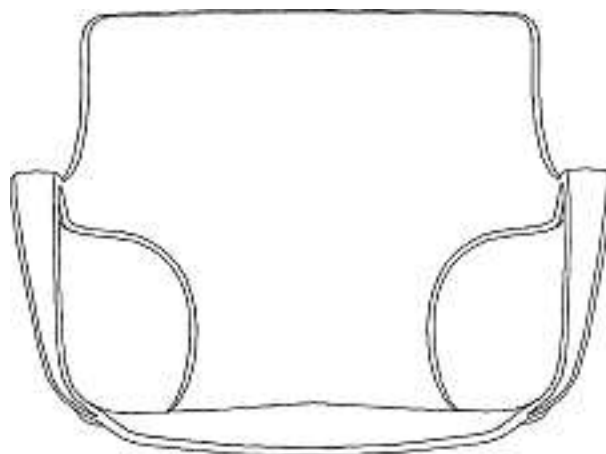

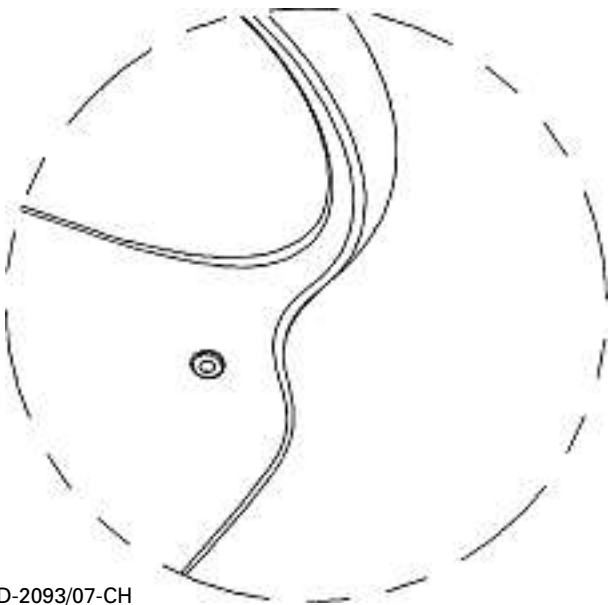
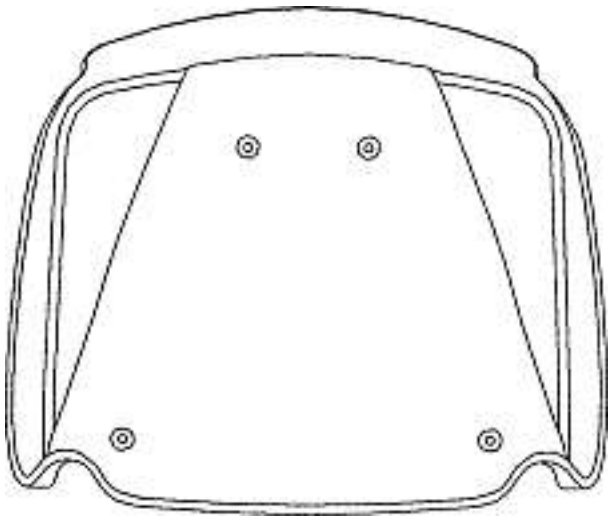

D-2093/07-CH

Cl. 06-01 134 433 08.10.2007
1 Design – Liege
Hinterleger: BECHTIGER, Folchartstrasse 1, 9000 St. Gallen
Designer: Andreas Bechtiger, St. Gallen



Liege "Klapp"

Cl. 06-01, 06-04 134 434 16.10.2007
3 Design – Hocker, Regale
Hinterleger: Michael Mettler, Badenerstrasse 123a,
8004 Zürich



Imelda



Imelda gestapelt

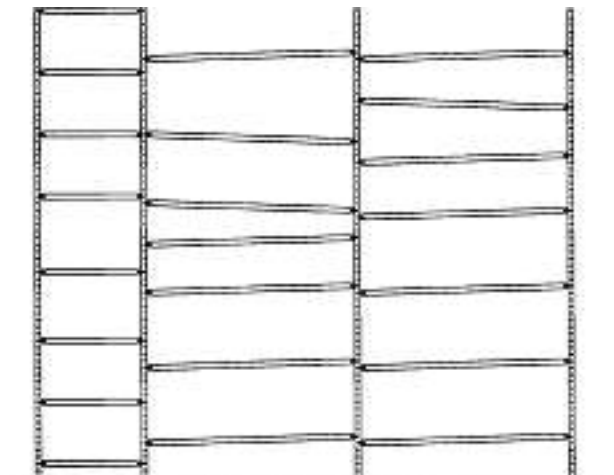

Oblique

Cl. 06-02 134 435 10.10.2007
 1 Design – Bett
 Hinterleger: Beat Huwlyer, Elekraweg 2, 5034 Suhr



PB11

Cl. 06-02 134 436 11.10.2007
 1 Design – Bett
 Hinterleger: Società Vetraria Biancadese SAS, Via Paris Bordone 82, 31030 Biancade di Roncade (Treviso), IT
 Designer: Riccardo Lucatello, Biancade
 Vertreter: Zimmerli, Wagner & Partner AG, 8001 Zürich
 Priorität: EM, 18.04.2007

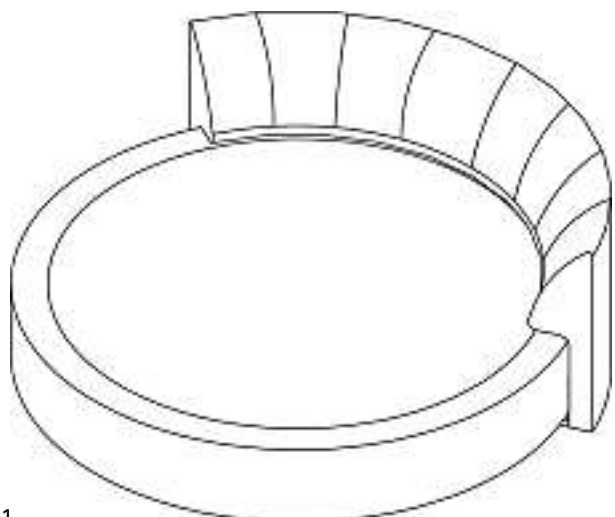
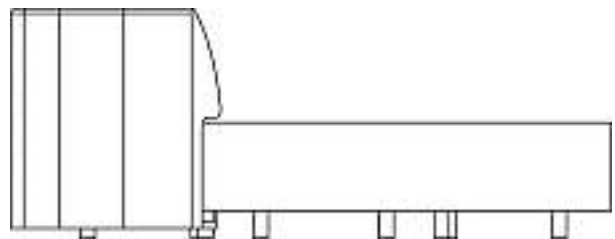
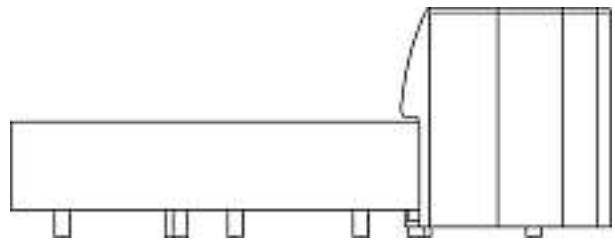
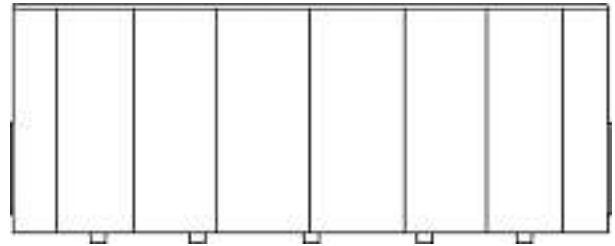
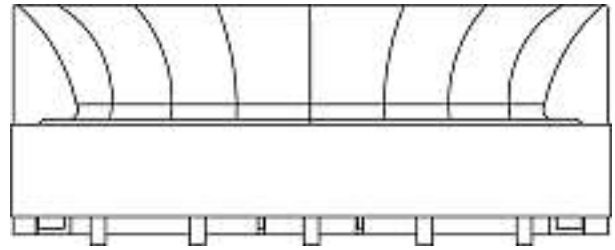
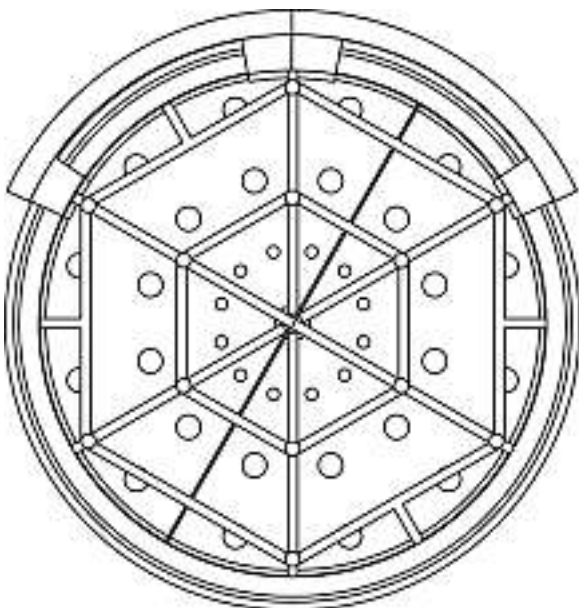
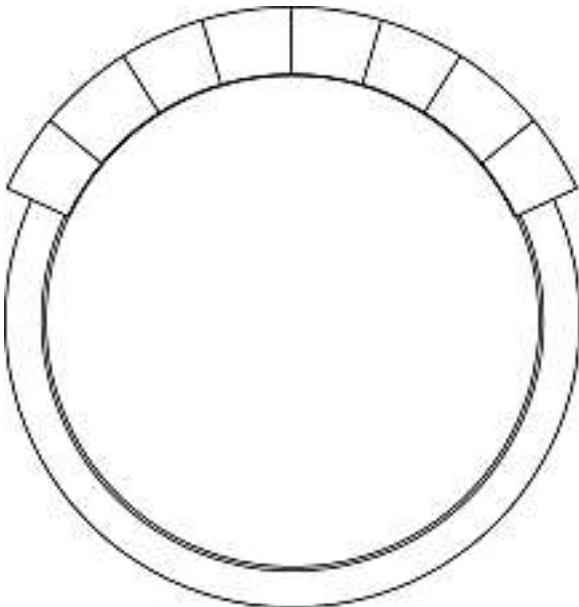

Cl. 06-04 134 437 18.09.2007
1 Design – Regal
Hinterleger: Martin Blaser, Nydeggestalden 1A, 3011 Bern

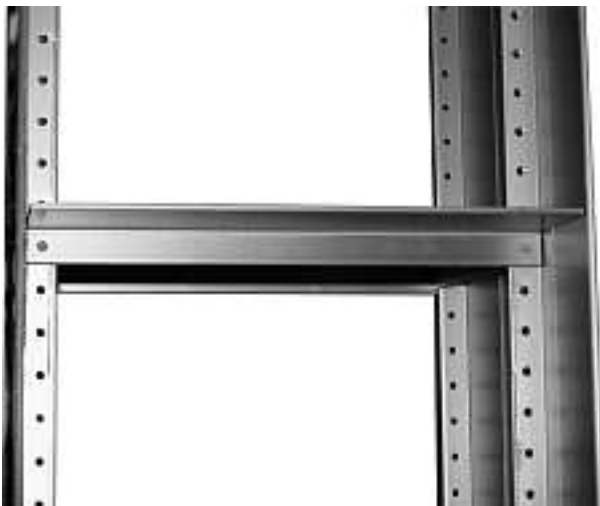

multiple R1

Cl. 06-06, 06-07 134 438 20.09.2007
2 Design – Raumteiler, Bilderrahmen
Hinterleger: Daniela Odermatt, Rheintalweg 95, 4125 Riehen

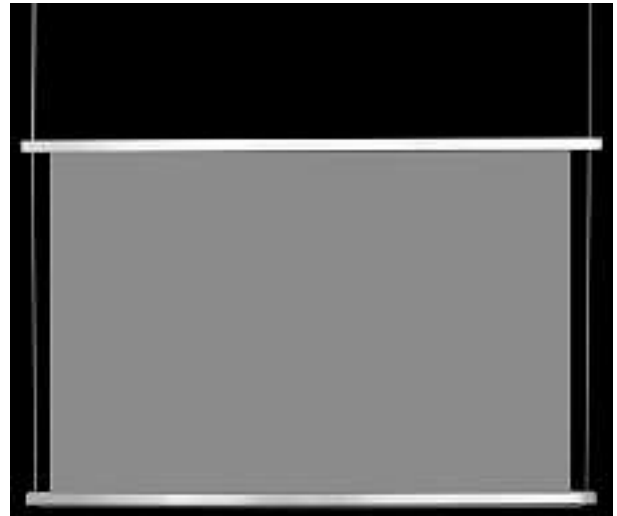

1

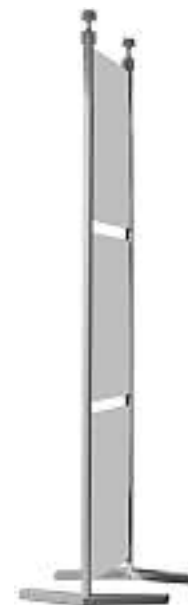
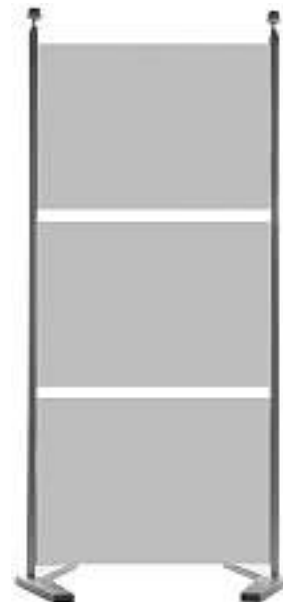

2

Cl. 06-06 134 439 03.10.2007
 3 Design – Möbel-Teil
 Hinterleger: Timuk GmbH, Weberstrasse 7, 8004 Zürich
 Designer: Patrik Gubser, Zürich

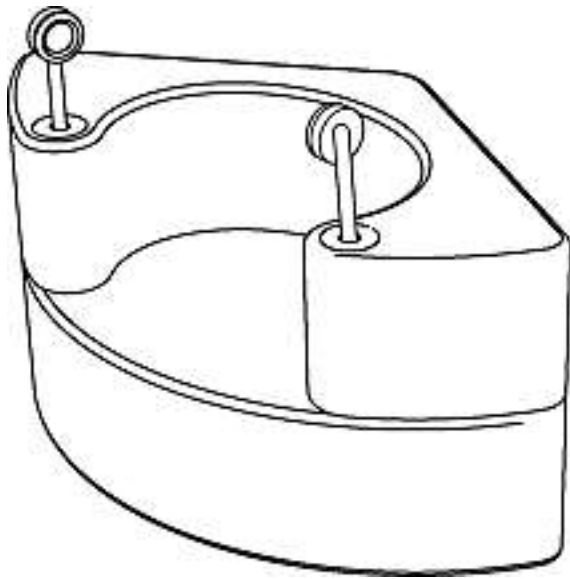

1

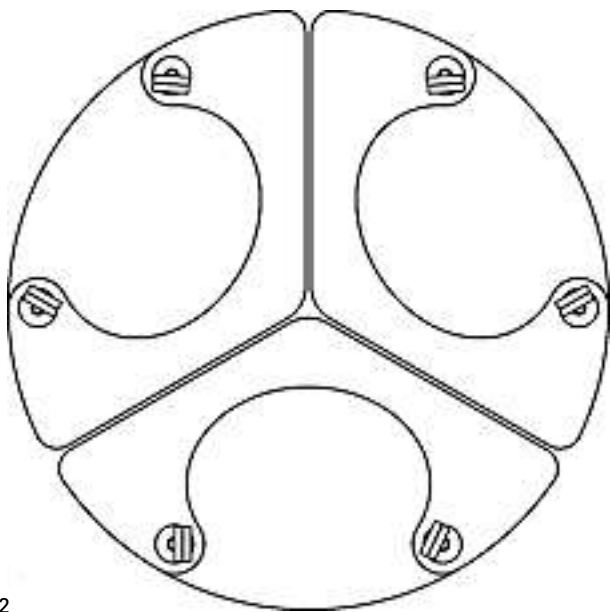

2

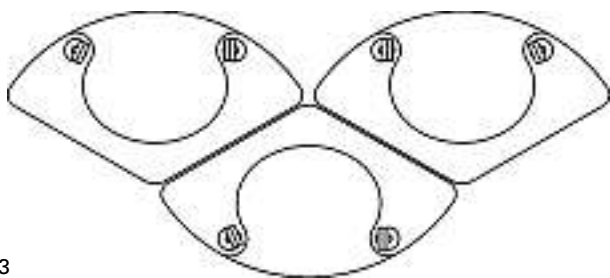

3

Cl. 06-08 134 440 04.10.2007
 1 Design – Kleiderbügel
 Hinterleger: Sandra Zahnd, Sonnegring 16, 3008 Bern
 Vertreter: IPTO AG, 3000 Bern 25



1

Cl. 07-01 134 441 02.10.2007
 1 Design – Eierbecher
 Hinterleger: Urs peter Furrer, Blotzheimerstrasse 30,
 4055 Basel
 Vertreter: Dr. Stefan Grundmann, 4001 Basel



1

Cl. 07-01 134 442 03.10.2007
1 Design – Trinkgefäss
Hinterleger: Pi-Design AG, Kantonsstrasse 100,
6234 Triengen
Designer: Jørgen Bodum, Meggen
Vertreter: Isler & Pedrazzini AG, 8027 Zürich
Priorität: DK, 03.05.2007



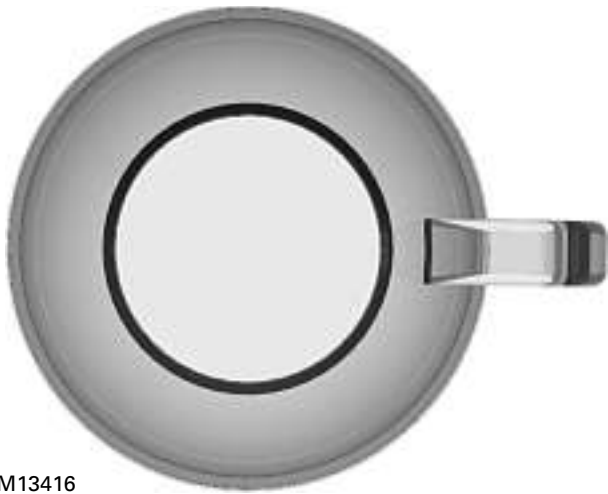

M13416

Cl. 07-01 134 443 09.10.2007
 2 Design – Getränkekrug
 Hinterleger: Pi-Design AG, Kantonsstrasse 100,
 6234 Triengen
 Designer: Jørgen Bodum, Meggen
 Vertreter: Isler & Pedrazzini AG, 8027 Zürich
 Priorität: DK, 07.05.2007

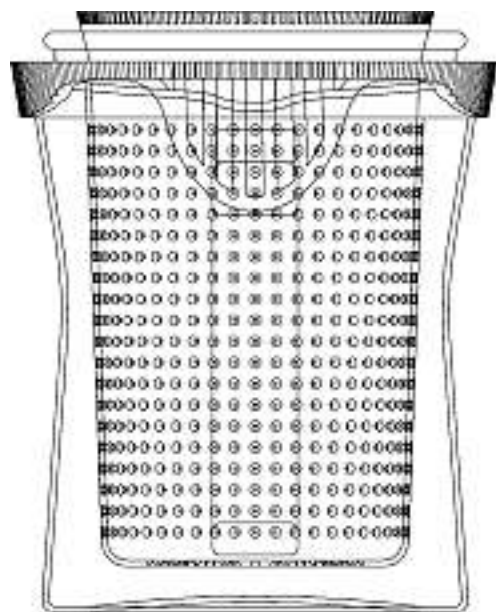
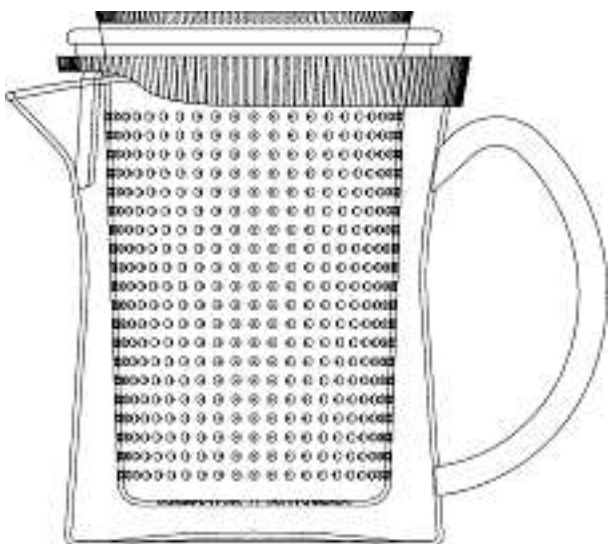
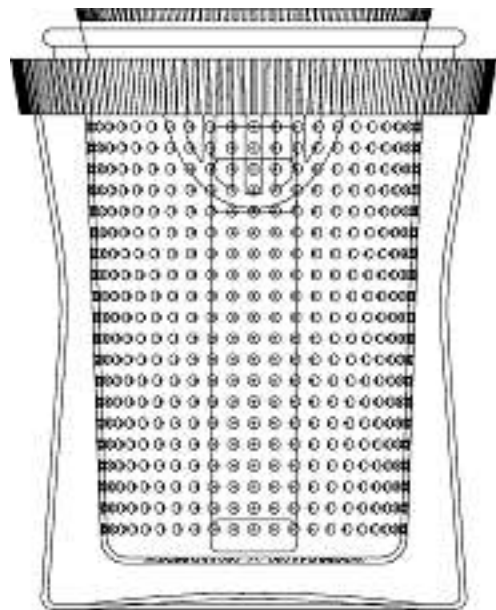
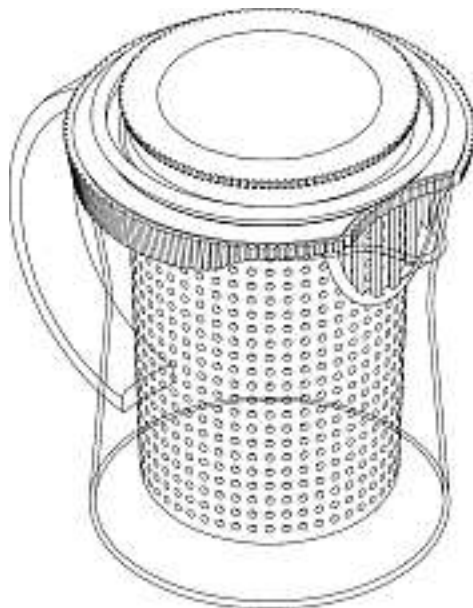

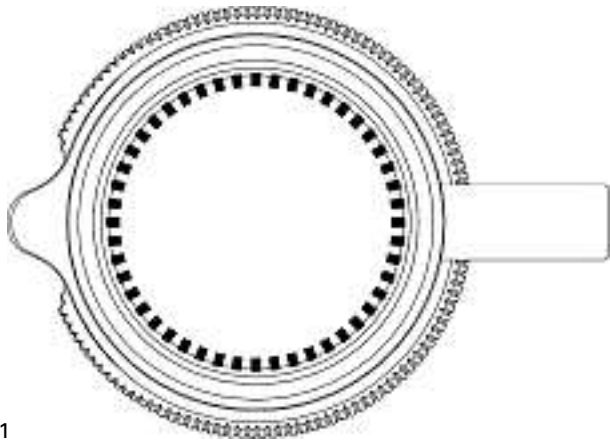
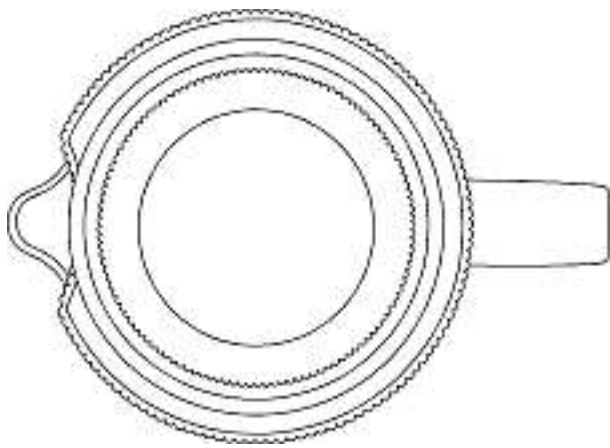

1

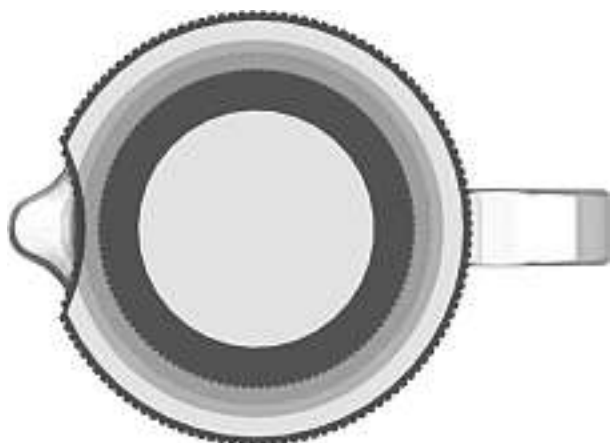

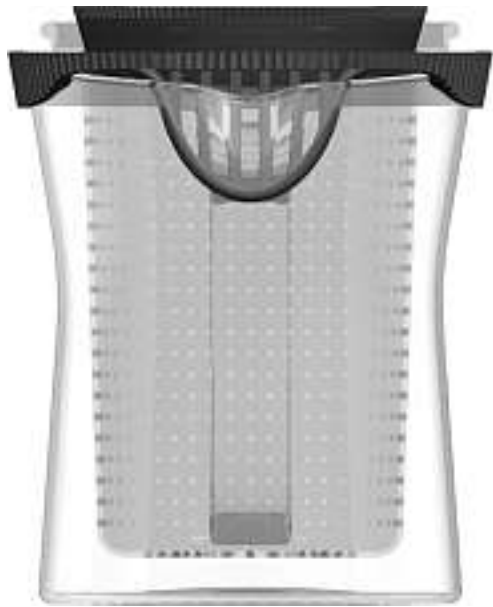

tasse + plus

Cl. 07-02 **134 445** 23.08.2007
 2 design – parties d'un grill
 Déposant: Shell Brands International AG, Baarermatte,
 6340 Baar
 Designer: Norbert Vernay, Rognac
 Mandataire: Kirker & Cie S.A., Ingénieurs-Conseils,
 1226 Genève - Thônex
 Priorité: EM, 13.03.2007

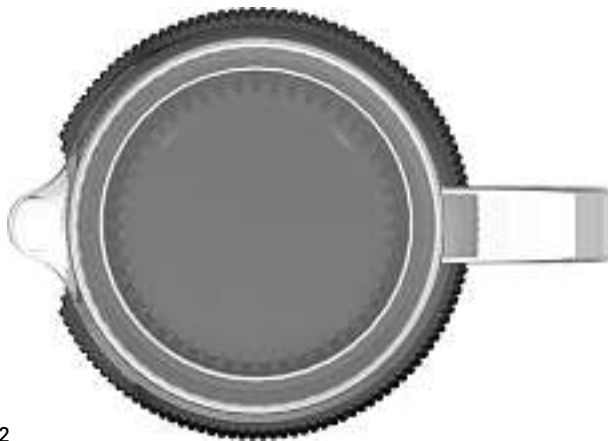

2



1



2

Cl. 07-01 **134 444** 18.10.2007
 1 design – vaisselle
 Déposant: Christine Fehr-Haldimann, La Fontaine,
 1864 Vers-L'Eglise



Cl. 07-02 **134 446** 23.08.2007
 3 design – parties d'un grill
 Déposant: Shell Brands International AG, Baarermatte,
 6340 Baar
 Designer: Norbert Vernay, Rognac
 Mandataire: Kirker & Cie S.A., Ingénieurs-Conseils,
 1226 Genève - Thônex
 Priorité: EM, 13.03.2007



1



2



3

Cl. 07-02 **134 447** 10.10.2007
 4 Design – Tischgrill
 Hinterleger: Domo Vision AG, Bernstrasse 7 A,
 4665 Oftringen
 Designer: Wolfgang Joensson, Paris
 Vertreter: Frei Patentanwaltsbüro AG, 8032 Zürich



1



2



3



4

Cl. 07-04 **134 450** 10.10.2007
 1 Design – Käsehobel
 Hinterleger: Traitements Thermiques S.A., Ile Falcon,
 3960 Sierre
 Designer: Pascal Burkard, Gerzensee



Hobel

Cl. 08-06 **134 451** 02.10.2007
 2 design – manopola
 Depositante: Vito Noto, Via dei Circoli 18, 6965 Cadro



MB1054.1



MB1054.2

Cl. 08-07 **134 452** 04.10.2007
 1 design – dispositif de verrouillage
 Déposant: Gripple Limited, The Old West Gun Works,
 Savile Street East, Sheffield S4 7UQ, GB
 Designer: Neil Clarke, Sheffield
 Mandataire: Kirker & Cie S.A., Ingénieurs-Conseils,
 1226 Genève - Thônex
 Priorité: EM, 10.04.2007

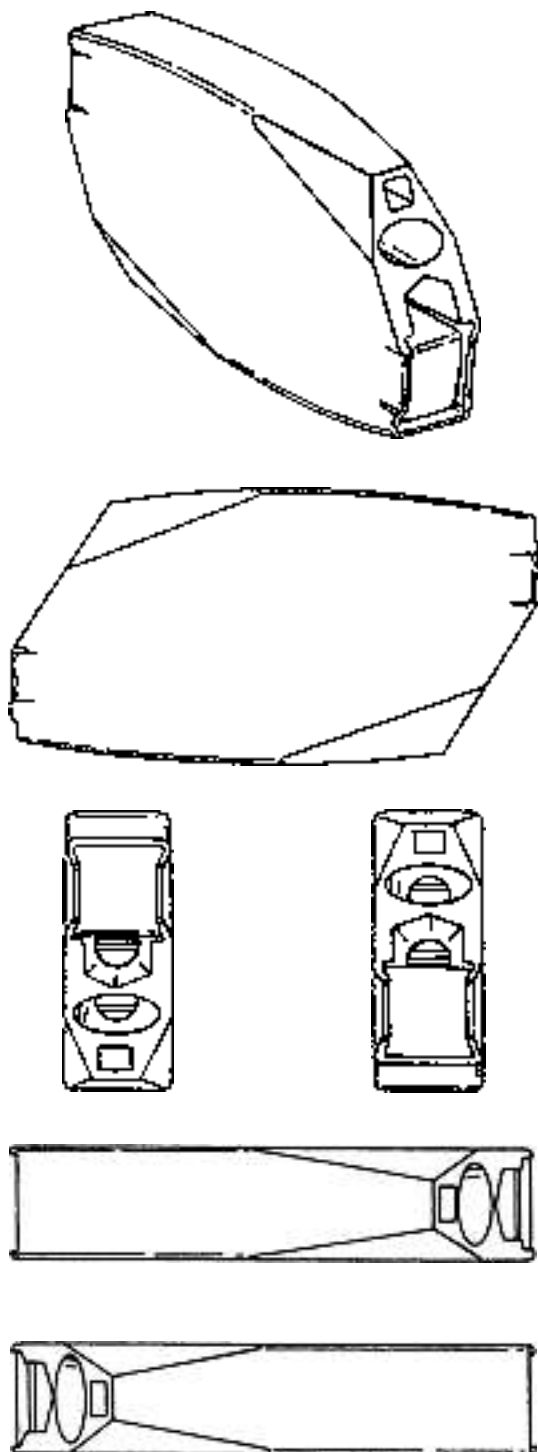

MPM/cl/310979-CH

Cl. 08-07 **134 453** 17.10.2007
 1 design – serrure pour articles de maroquinerie
 Déposant: JM WESTON, Rue Nicolas Appert, Zone
 Industrielle Nord, Limoges, FR
 Designer: Jean-Christopher Descours, Limoges
 Mandataire: Griffes Consulting S.A., 1206 Genève
 Priorité: FR, 19.04.2007

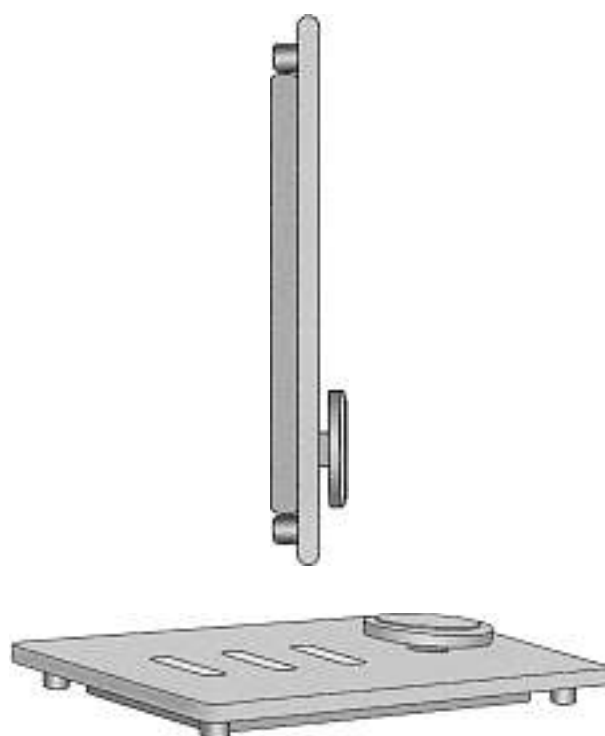

0111-MO-0065-CH-CH-01

Cl. 09-09 **134 454** 02.10.2007
 2 Design – Abfallentsorgungsbehälter
 Hinterleger: Entsorgungstechnik.ch AG, Silberstrasse 8,
 8953 Dietikon
 Designer: Eberhard Walther, Boppelsen
 Vertreter: RA Patrick Bonzanigo, 8024 Zürich

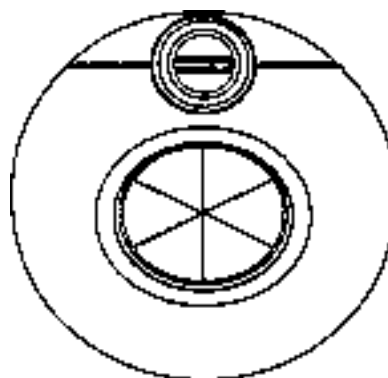

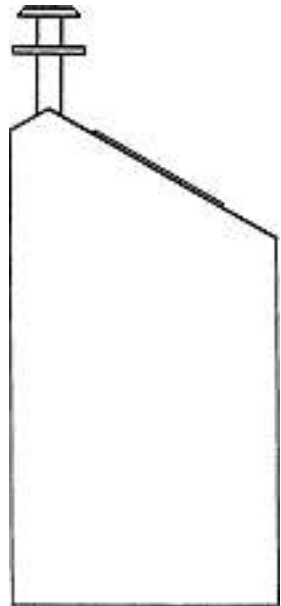
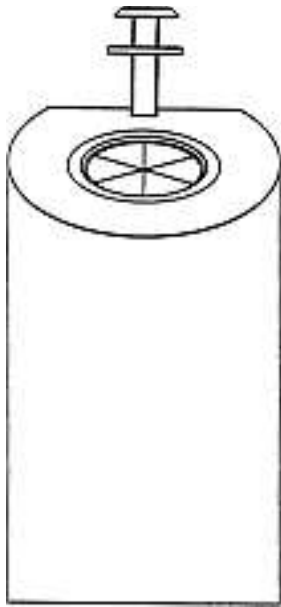

Gossau

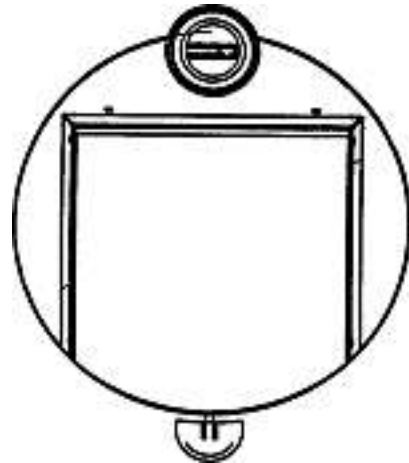
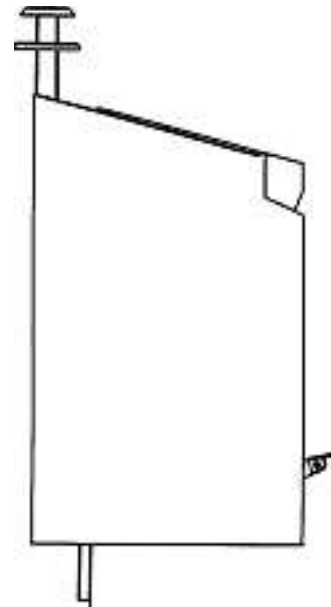
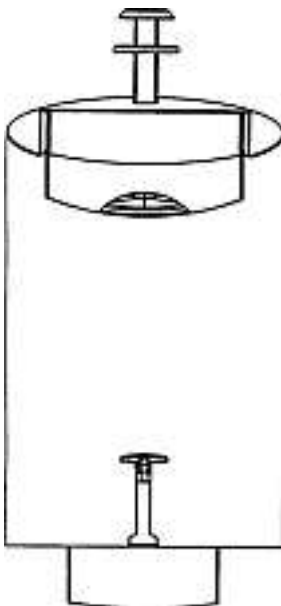

Bern

Cl. 10-02, 10-07 **134 455** 04.10.2007
5 design – montres
Déposant: Vincent Bérard SA, boulevard des Endroits 24,
2300 La Chaux-de-Fonds
Designer: Vincent Bérard, La Chaux-de-Fonds
Mandataire: Kirker & Cie S.A., Ingénieurs-Conseils,
1226 Genève - Thônex
Priorité: EM, 05.04.2007

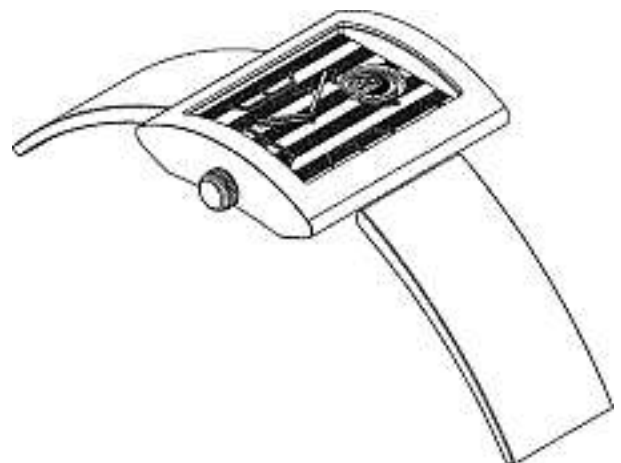

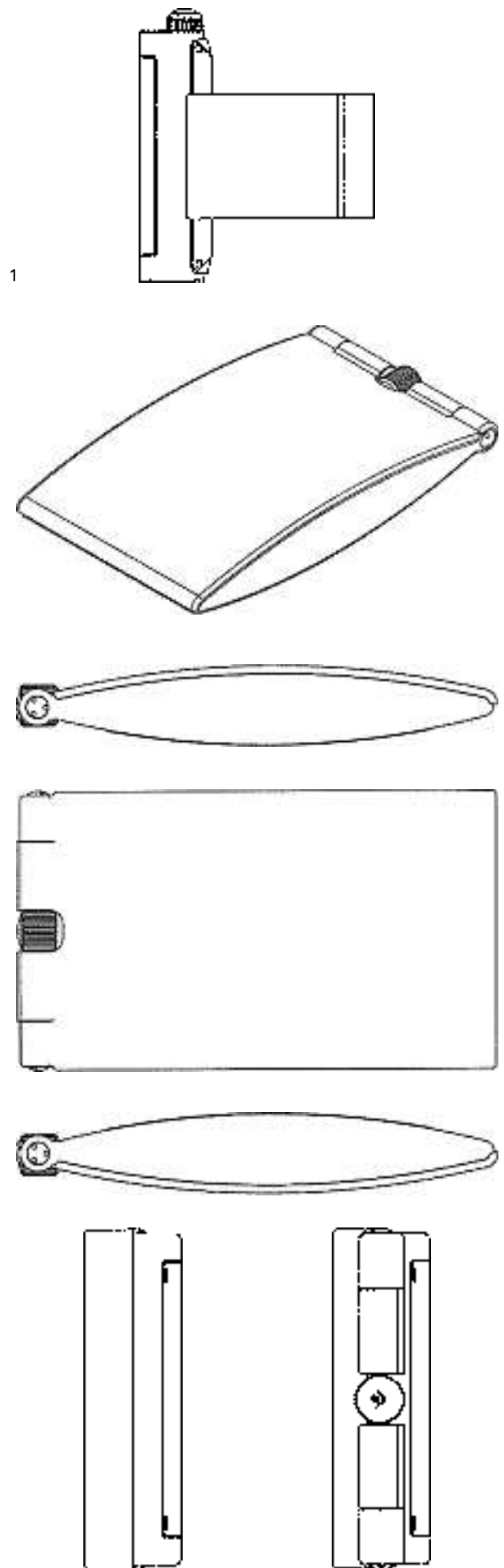
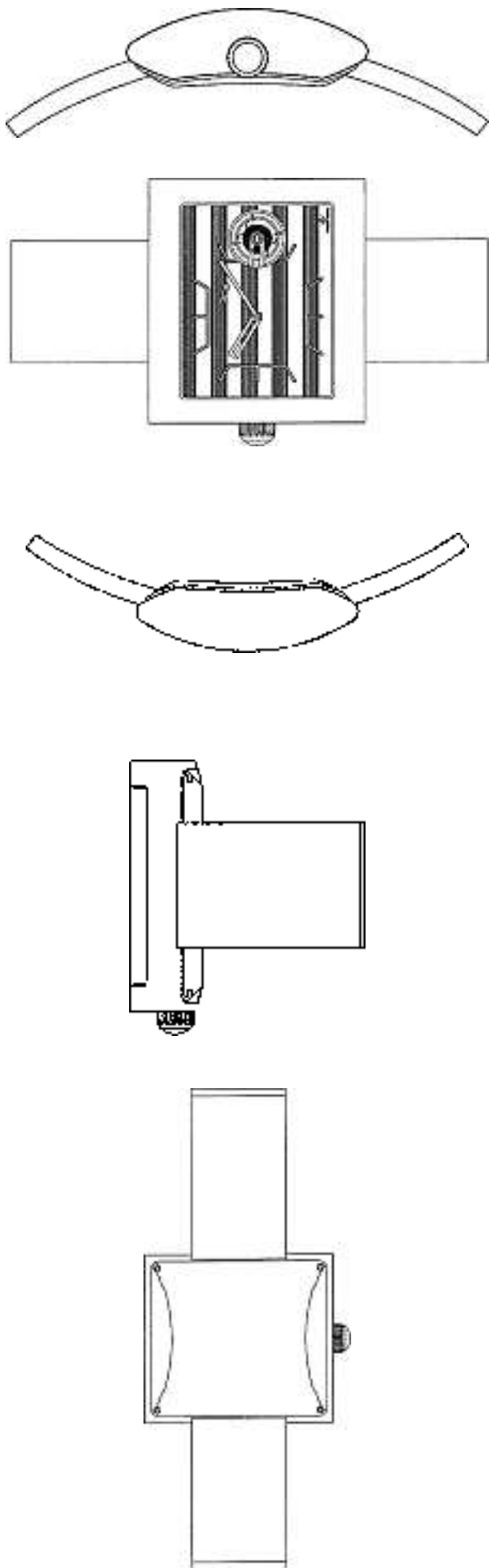

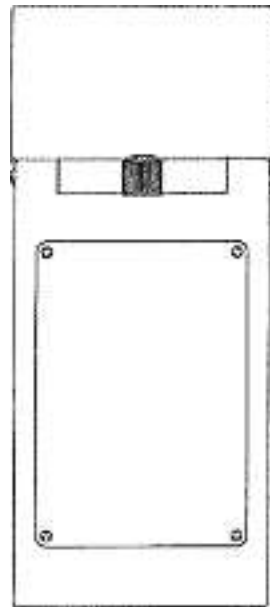
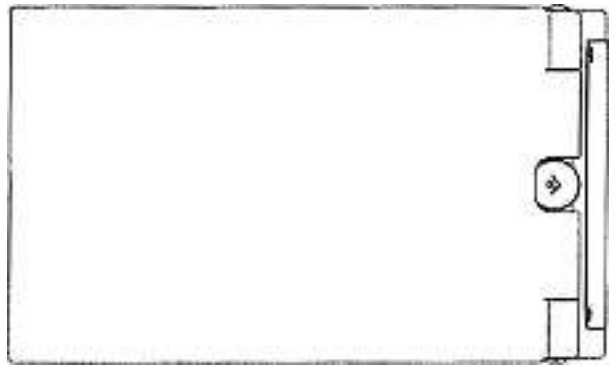
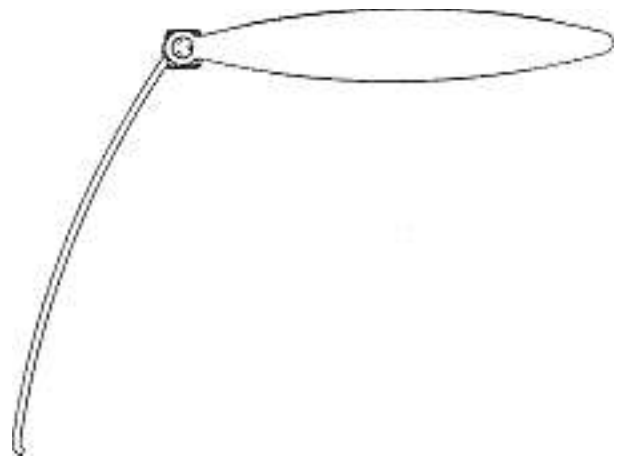
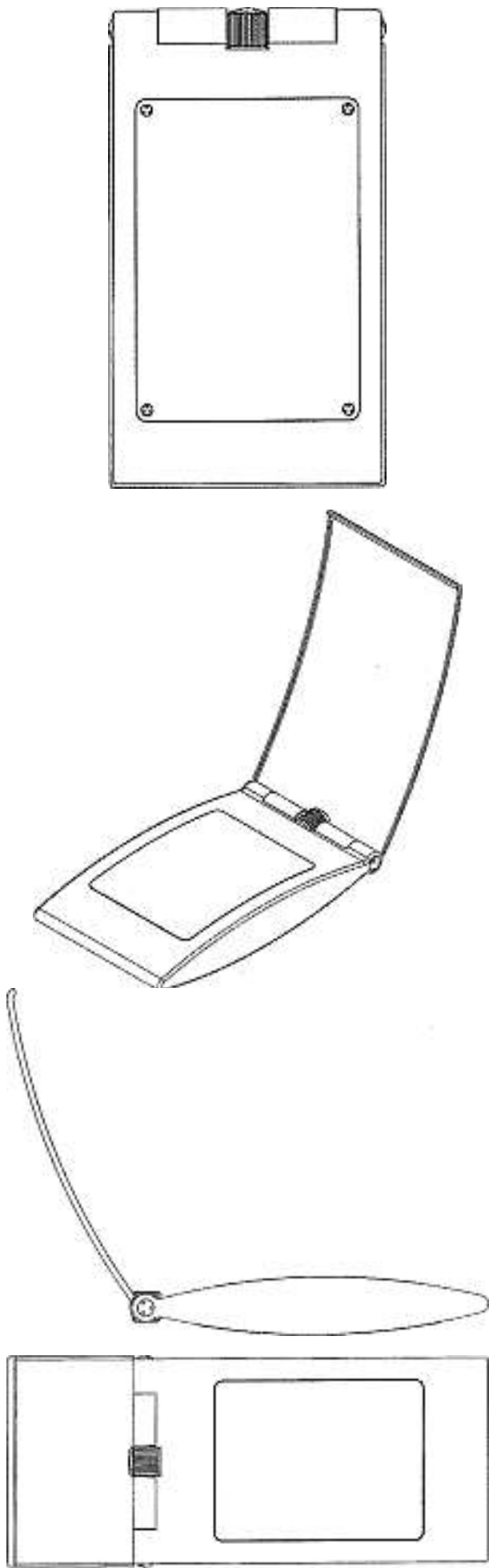

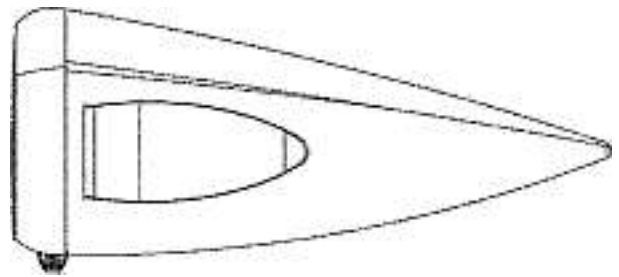
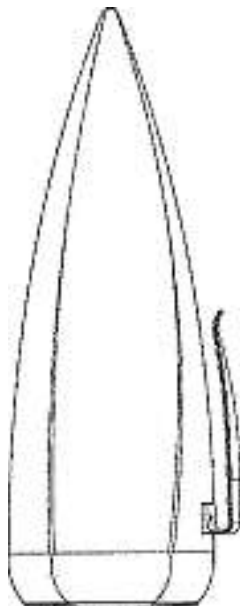
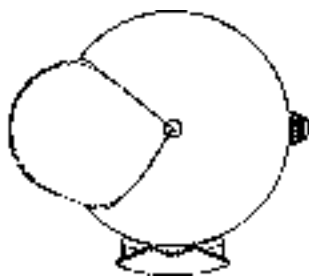
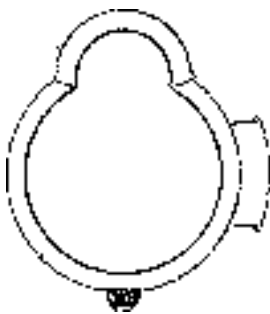

3

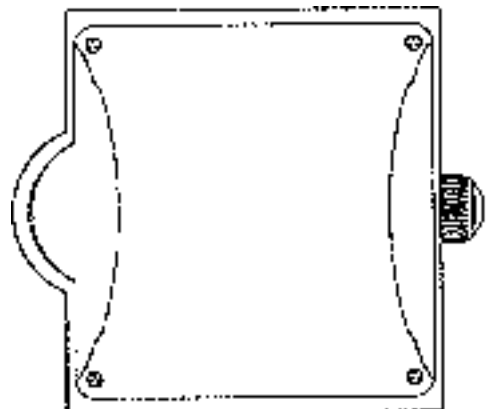
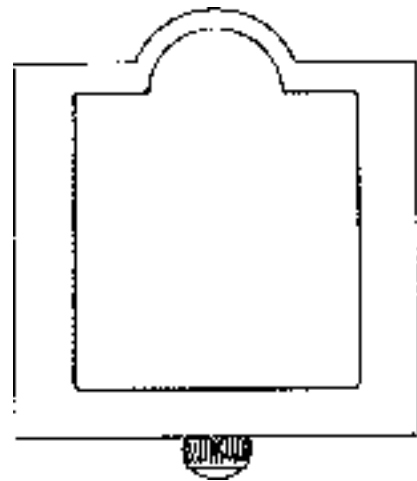
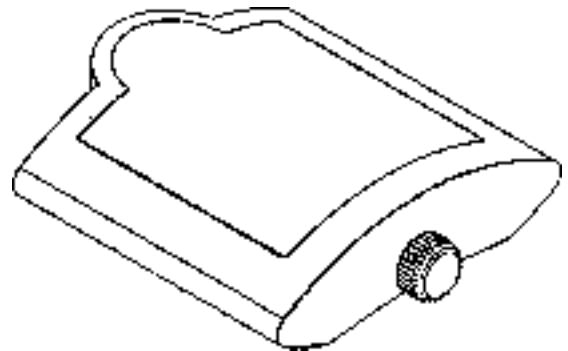

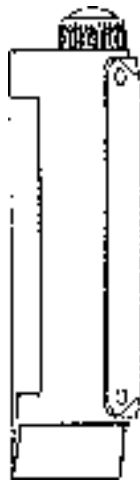
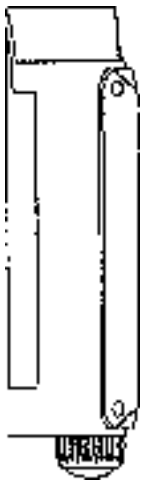
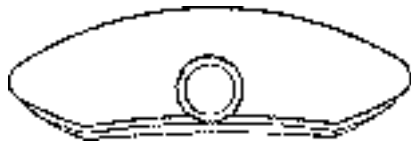

4

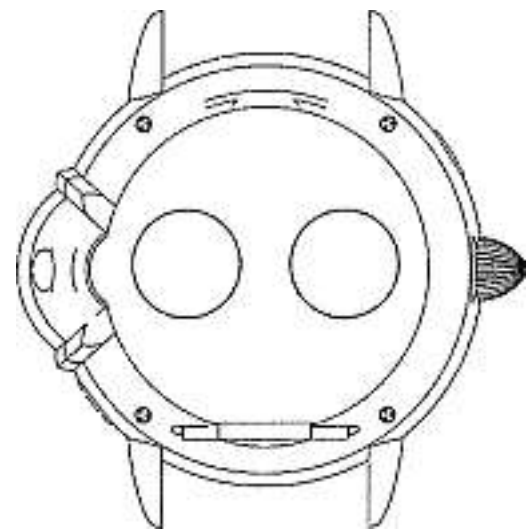
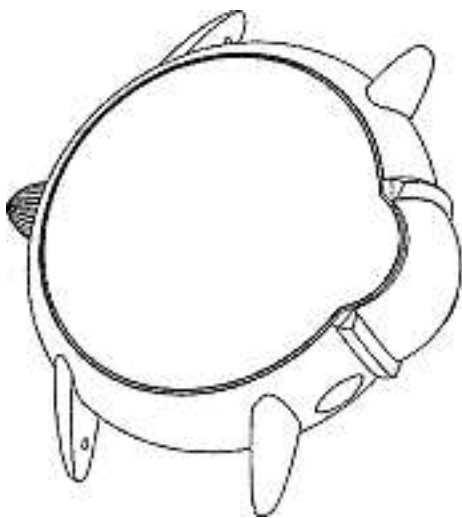
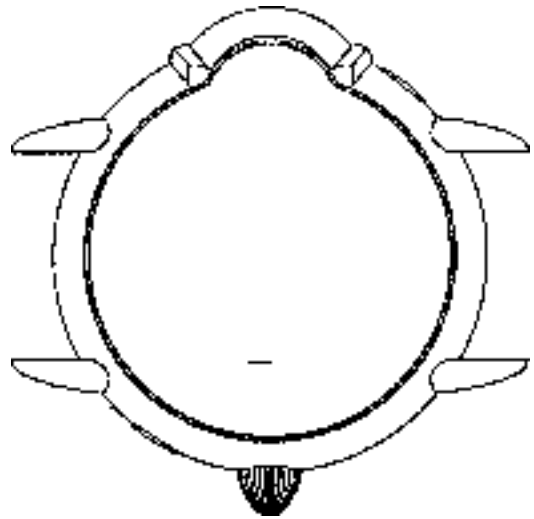
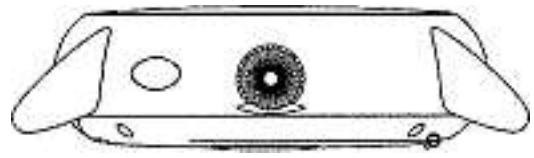

5

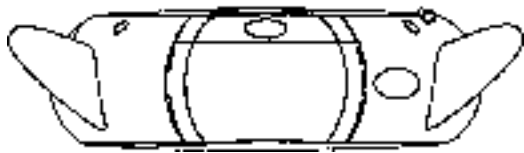

Cl. 10-02 134 456 31.10.2007
6 design – montres-bracelets
Déposant: Jovial Montres SA, 5, rue E.-Schüler, 2500 Bienne 3
Designer: Jean-Claude Racine, Bienne



6606G



6602L



6610L



6605G



6614L



6617G



LMS

Cl. 10-04, 10-05 134 457 03.10.2007
 2 Design – Messgeräte
 Hinterleger: Christian Mangold, Schützenstrasse 30,
 8304 Wallisellen
 Beschreibung des Designs: Traffic-Observer, laserbasieren-
 des Geschwindigkeitsmessgerät, mit integrierten Kameras in
 zwei Richtungen messend.

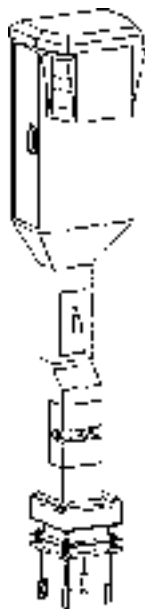

Traffic-Observer

Cl. 11-02 134 458 26.09.2007
 1 design – diffuseur
 Déposant: Lucia Bender, Av. de la Gare 38, 1920 Martigny
 Designer: Jacques Pierroz, Martigny





CANISNET

Cl. 12-11 134 459 01.10.2007
 1 Design – Motorrad
 Hinterleger: Honda Motor Co., Ltd., No. 1-1, 2-chome,
 Minami-aoyama, Minato-ku, Tokyo, JP
 Designer: Hirotugu Uneo, Saitama; Tetsuya Nakazawa,
 Saitama; Teofiro Plaza, Rom
 Vertreter: E. Blum & Co. AG, Patent- und Markenanwälte VSP,
 8044 Zürich
 Priorität: JP, 06.04.2007





1

Cl. 13-03 134 460 16.10.2007

2 design – appareils de commutation

Déposant: Schneider Electric Industries SAS, 89, boulevard Franklin Roosevelt, 92500 Rueil-Malmaison, FR

Designer: Jean Decosse, Chirens

Mandataire: William Blanc & Cie, Conseils en Propriété Industrielle S.A., 1220 Les Avanchets/Genève

Priorité: EM, 20.04.2007; EM, 20.04.2007



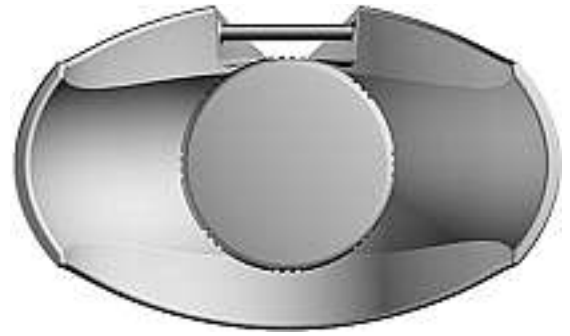

1

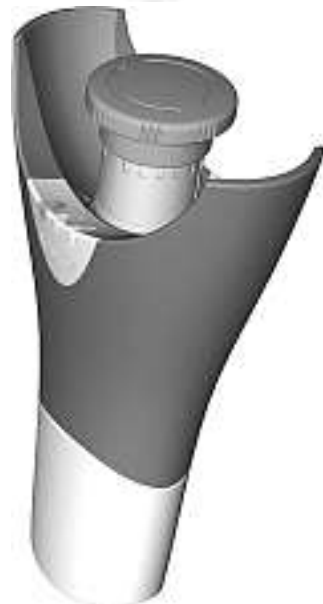



Cl. 14-02 134 461 12.10.2007
2 design – terminal de paiement
Déposant: Hypercom Corporation, 2851 West Kathleen Road,
Phoenix AZ, US
Designer: Chris Henry, Phoenix
Mandataire: Lemman Consulting S.A., 1260 Nyon
Priorité: US, 16.04.2007

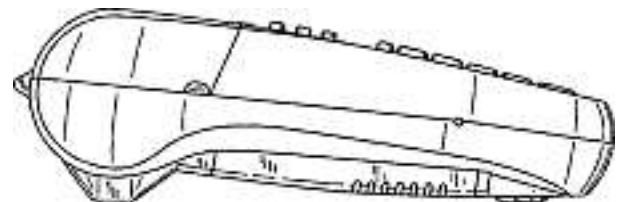
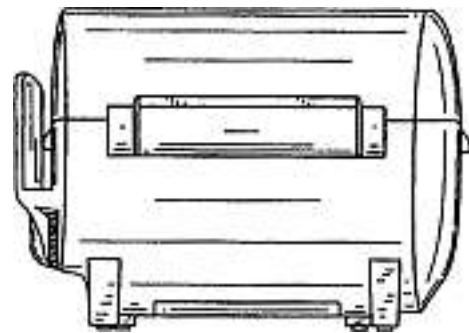
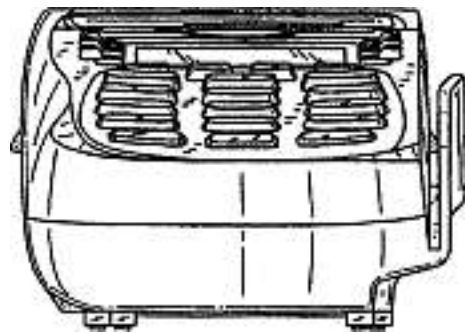

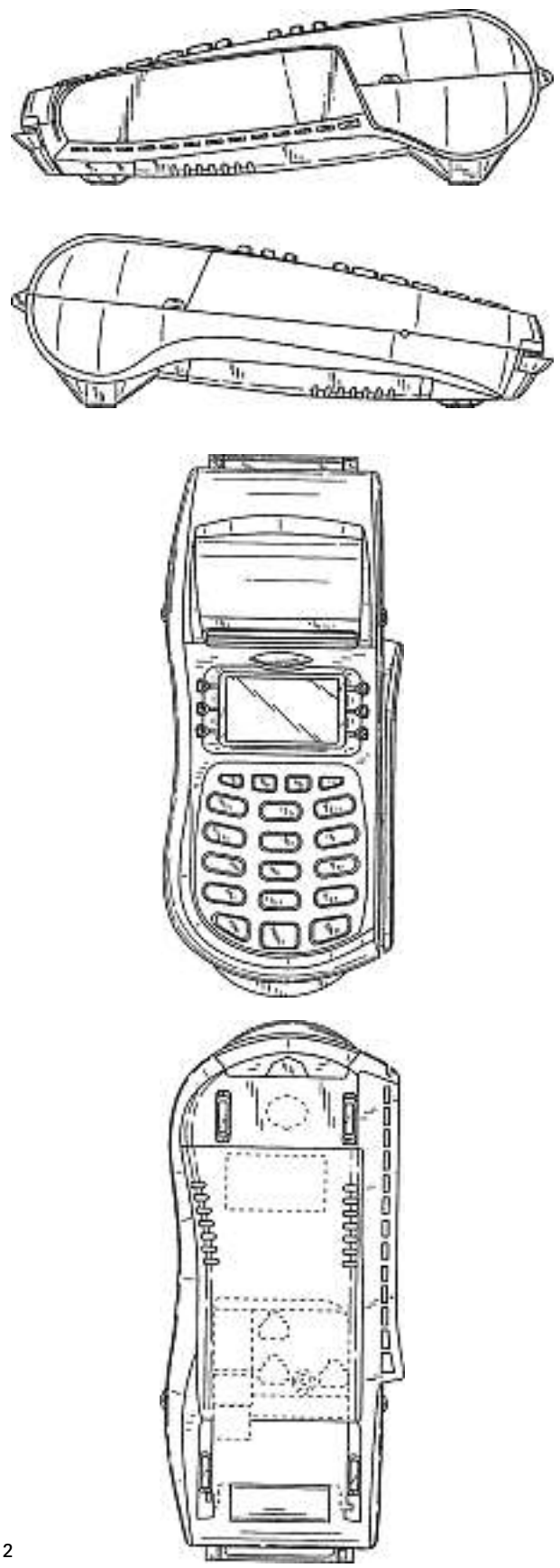

Cl. 14-03 **134 462** 17.10.2007
 1 Design – Fernbedienung
 Hinterleger: Zumtobel Lighting GmbH & Co. KG,
 Grevenmarschstrasse 74-78, Lemgo, DE
 Designer: James Irvine, Milano
 Vertreter: A. Braun, Braun, Héritier, Eschmann AG,
 Patentanwälte, 4051 Basel
 Priorität: EM, 17.04.2007

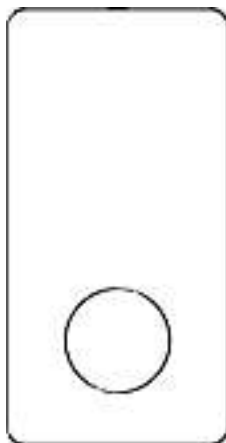

1



Cl. 15-05 134 464 02.10.2007
2 Design – Staubsauger
Hinterleger: Aktiefbolaget Electrolux, Stockholm, SE
Designer: Anna-Karin Gray, Stockholm; Jamian Cobbett, New York
Vertreter: Troesch Scheidegger Werner AG, Patent- und Markenanwälte, 8126 Zumikon
Priorität: SE, 07.06.2007

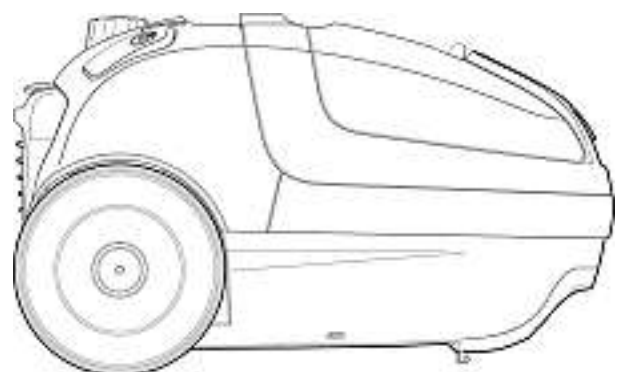
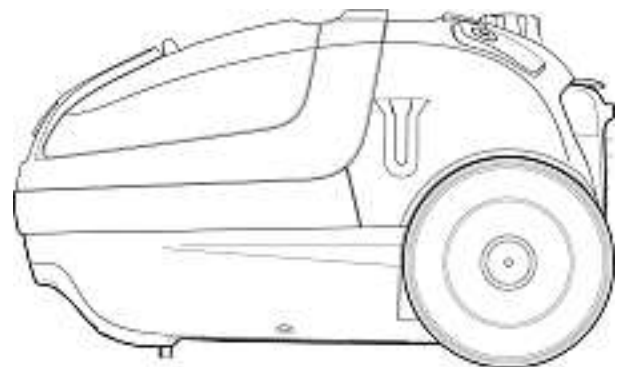
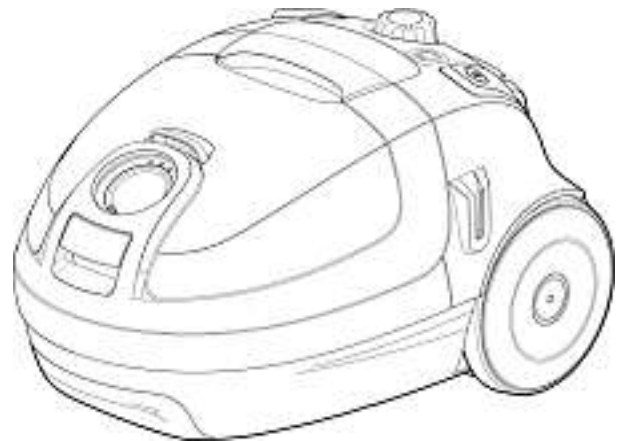

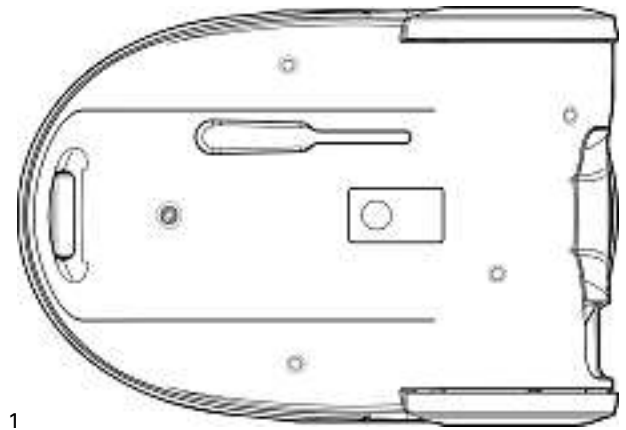
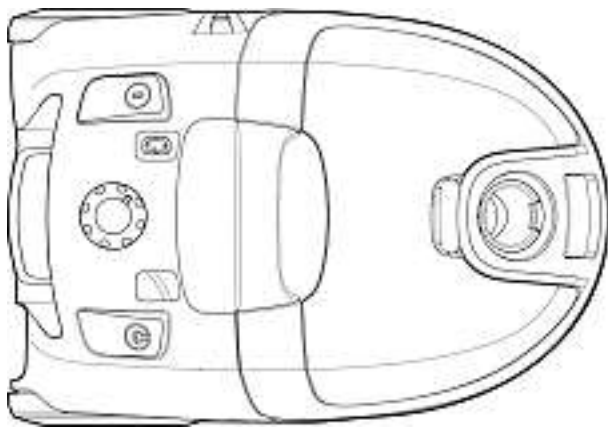

1

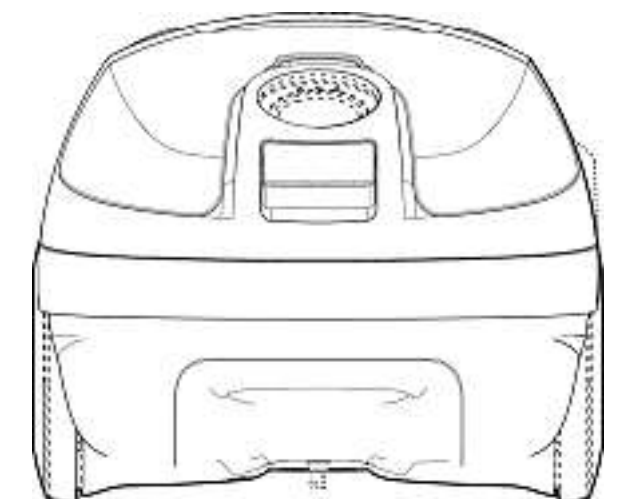
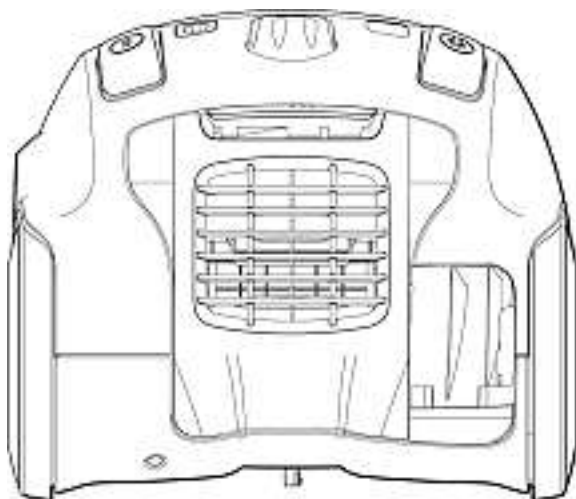
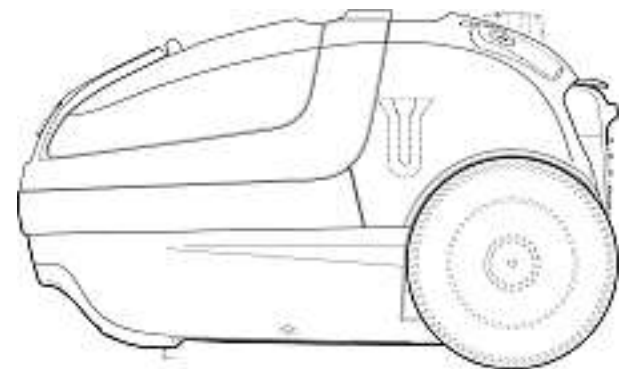
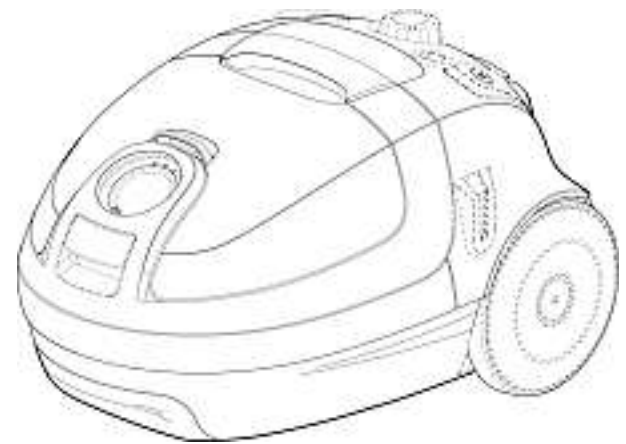
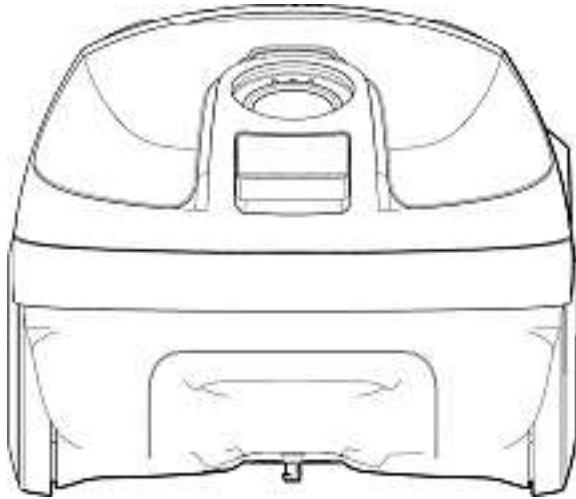

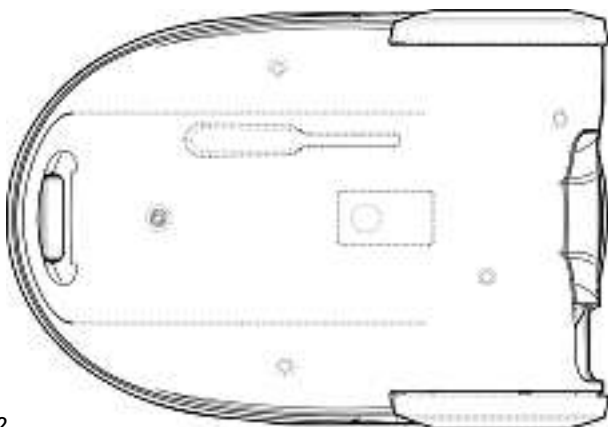
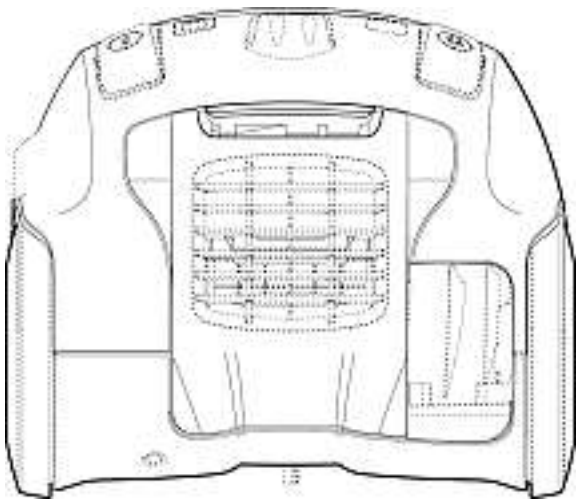
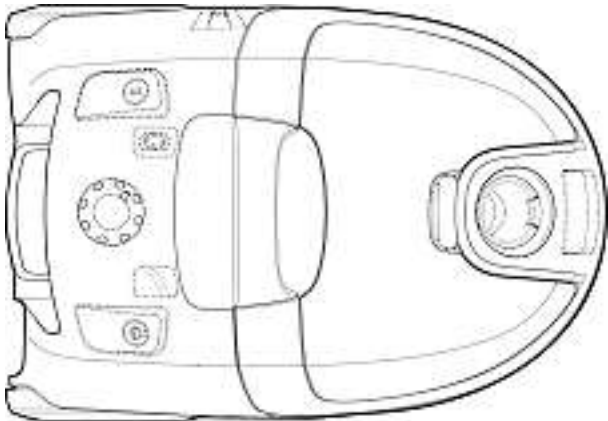
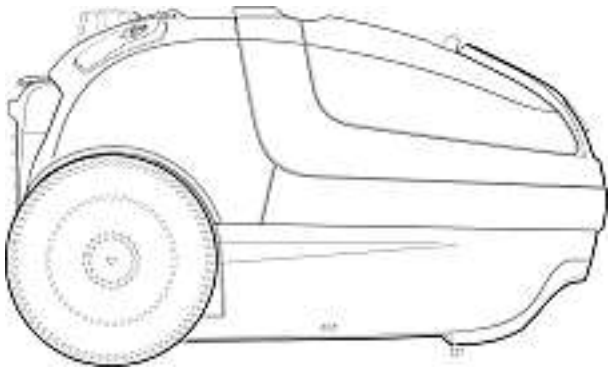

2

Cl. 15-07 134 465 24.09.2007
9 Design – Gefriertruhen
Hinterleger: Carrier Corporation, One Carrier Place,
Farmington, Connecticut 06034-4015, US
Designer: Harry Finkenauer, Mainz-Kostheim; Ortwin Schäfer,
Riedstadt; Stefanie Kohlisch, Frankfurt am Main
Vertreter: A. Braun, Braun, Héritier, Eschmann AG,
Patentanwälte, 4051 Basel
Priorität: EM, 23.03.2007

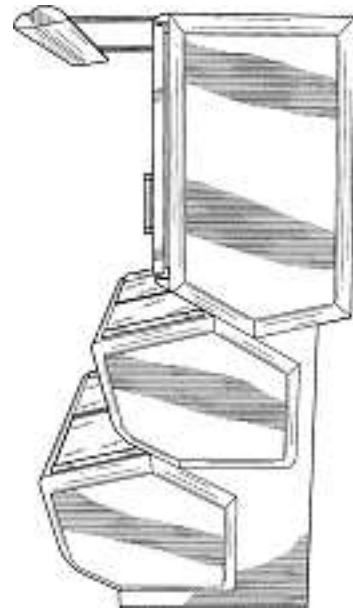

1



2

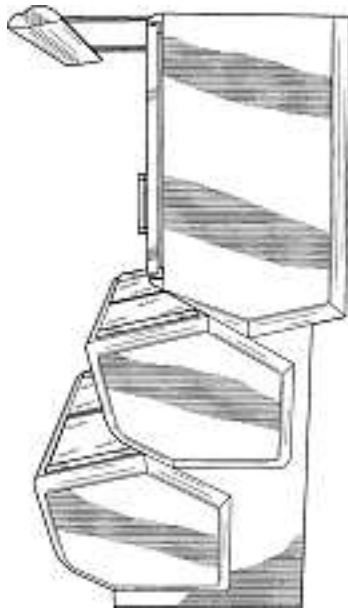

3

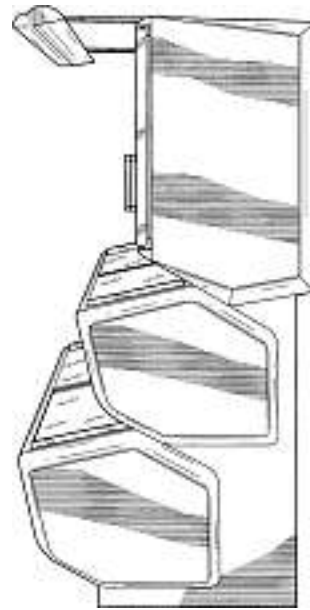

5



4



6

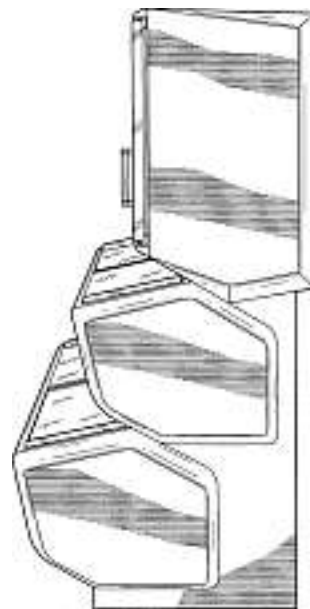



7

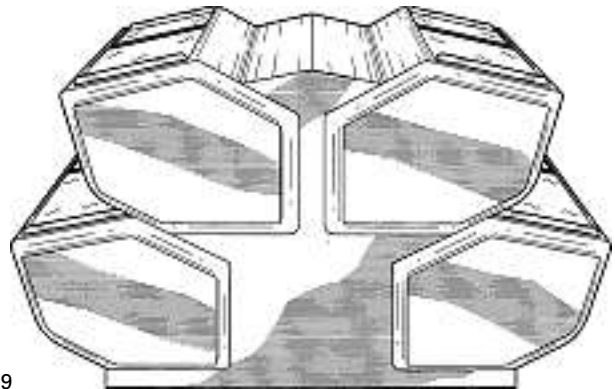
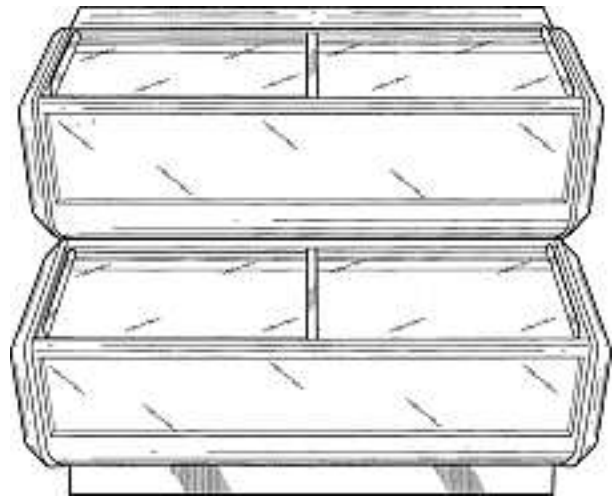
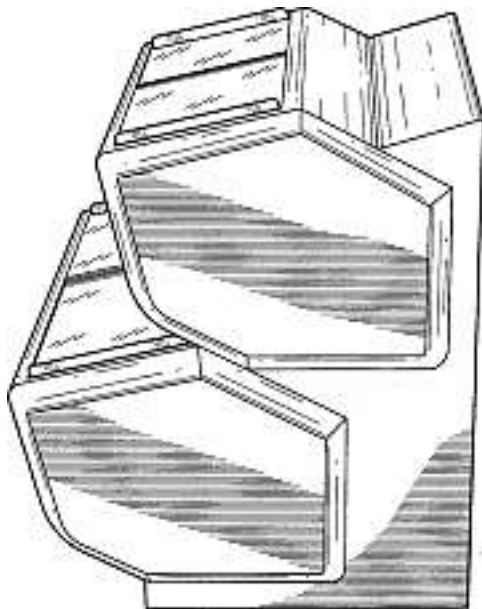

9

Cl. 18-03 134 466 01.10.2007
 1 Design – Schriftart
 Hinterleger: Bang & Olufsen a/s, Peter Bangs Vej 15,
 Postboks 40, Struer, DK
 Designer: Mads Quistgaard, Copenhagen
 Vertreter: A.W. Metz & Co. AG, 8024 Zürich
 Priorität: DK, 03.07.2007

abcdefghijklmnopqrstuvwxyæøå

ABCDEFGHIJKLMNOPQRSTUVWXYZ.EØÅ

1234567890.,:;(*!?'')

1

Cl. 19-06 134 467 11.10.2007
 2 Design – Korrekturstifte
 Hinterleger: Kores Holding Zug AG, Baarerstrasse 112,
 6302 Zug
 Designer: Peter Koreska, Wien
 Vertreter: Isler & Pedrazzini AG, 8027 Zürich
 Priorität: EM, 26.04.2007; EM, 26.04.2007

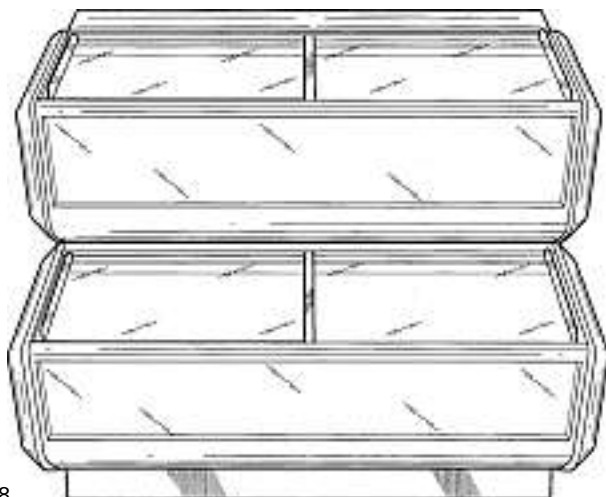
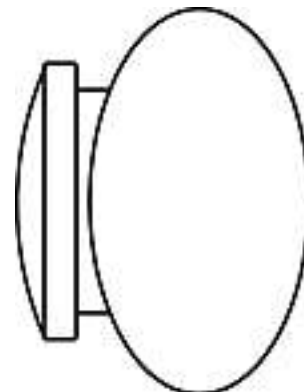

8

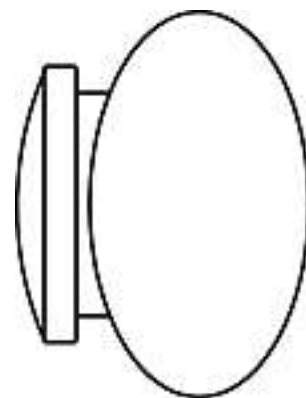
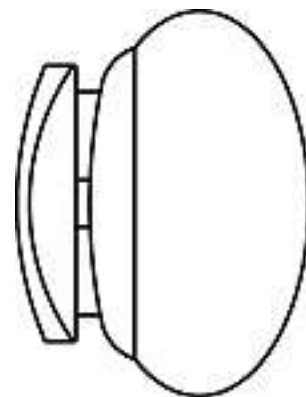
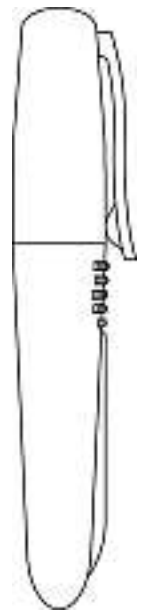
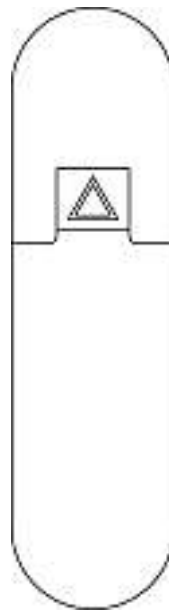
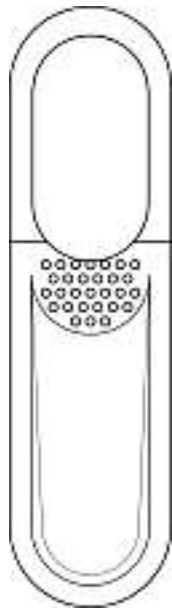
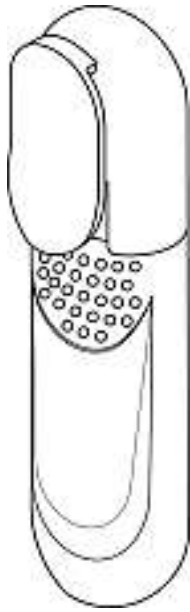

M13419-1

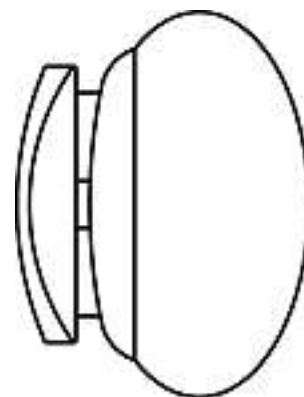
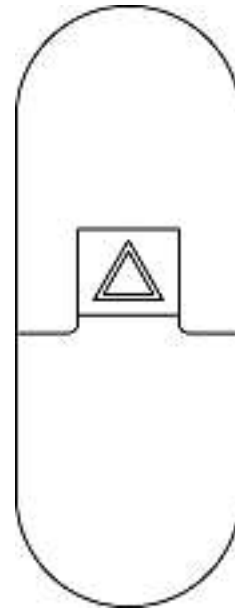
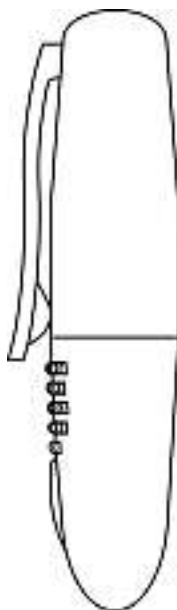
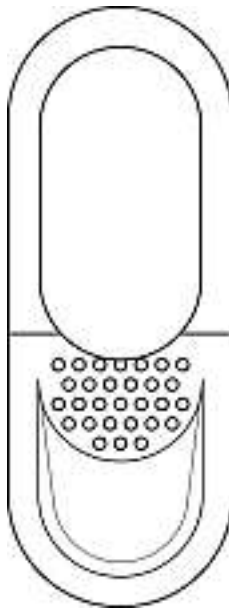
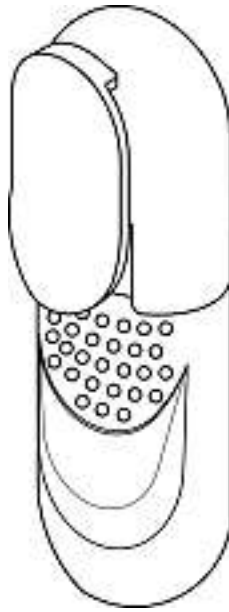

M13419-2

Cl. 21-02 **134 468** 31.07.2007
 5 Design – Ball
 Hinterleger: adidas International Marketing B.V., Koningin
 Wilhelminaplein 30, 1062 KR Amsterdam, NL
 Designer: Thomas Weege, Eckental
 Vertreter: Patentanwaltsbüro Jean Hunziker AG,
 8126 Zumikon
 Priorität: EM, 23.04.2007

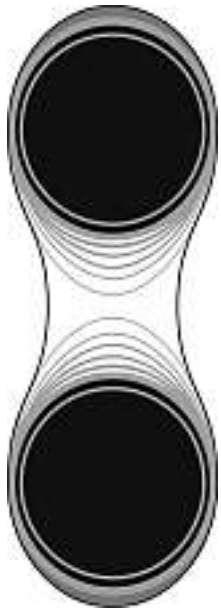

D300220-1



D300220-4

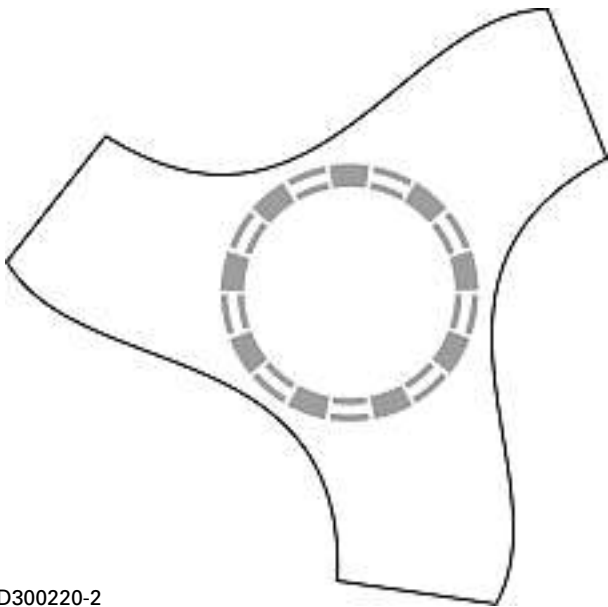

D300220-2

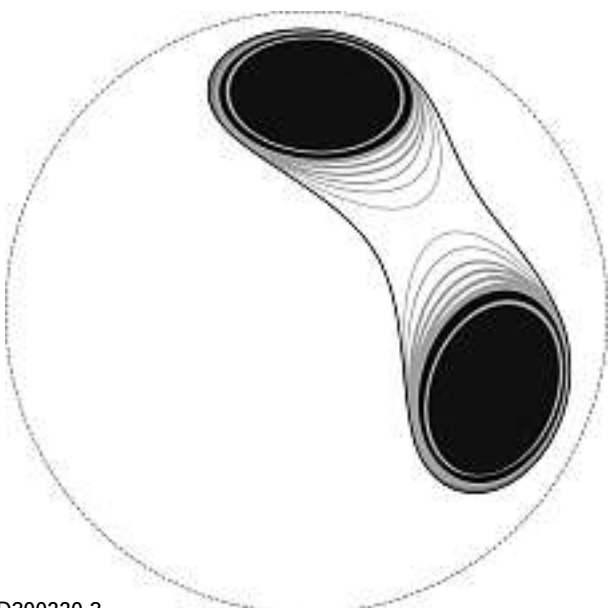
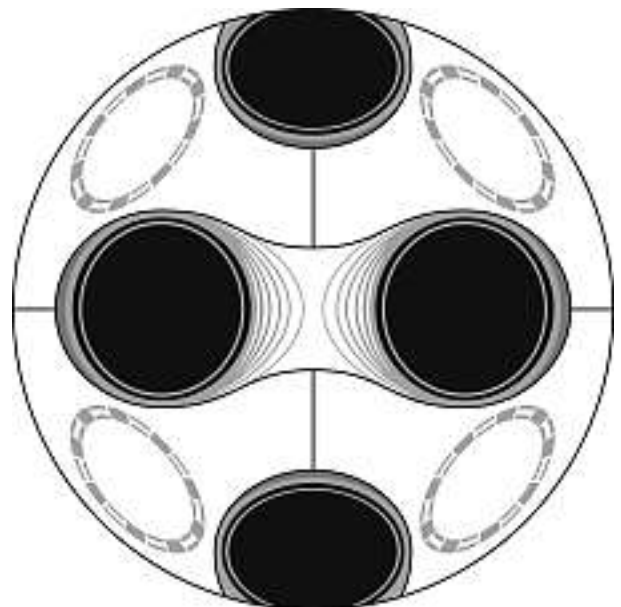

D300220-3

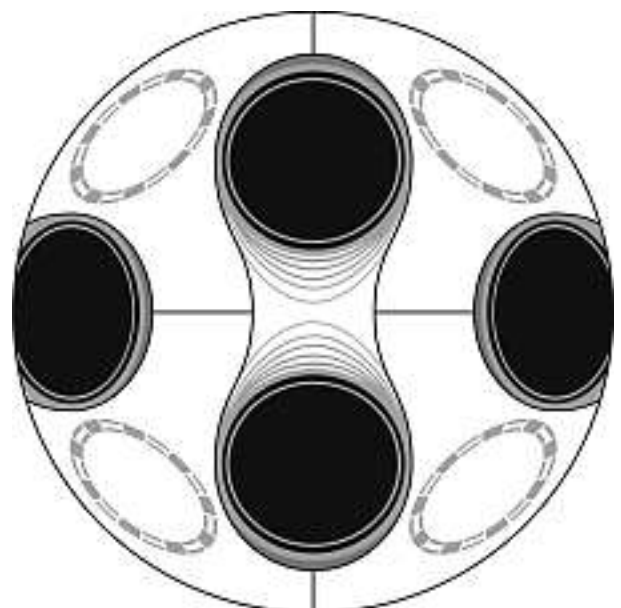



D300220-5

Cl. 23-04 134 469 27.09.2007
1 Design – Luftbefeuchter
Hinterleger: Plaston AG, Espenstrasse 85, 9443 Widnau
Designer: Manfred Fitsch, St. Gallenkirch
Vertreter: Werner Bruderer, Patentanwalt, 8330 Pfäffikon ZH

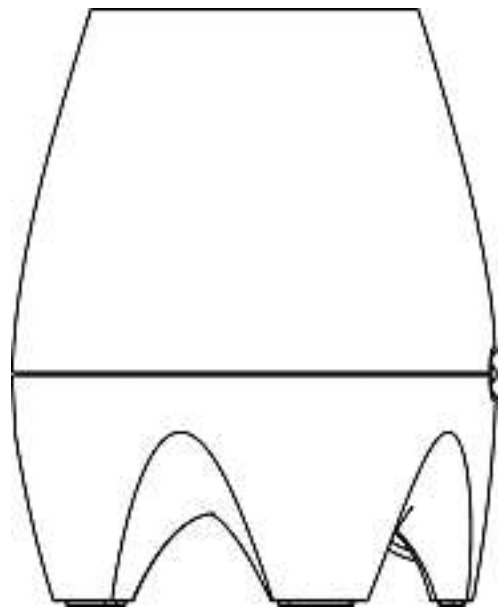
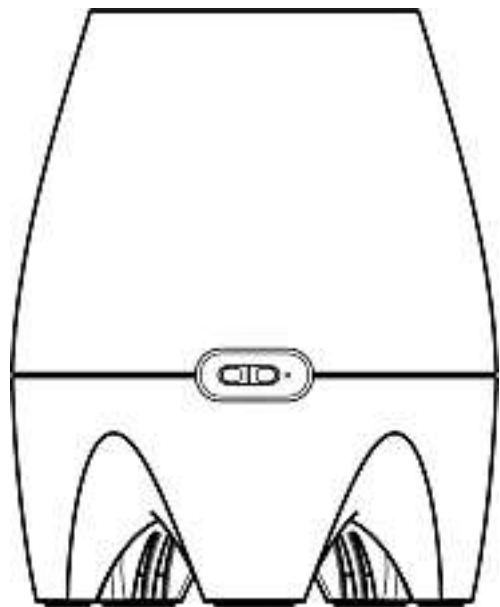
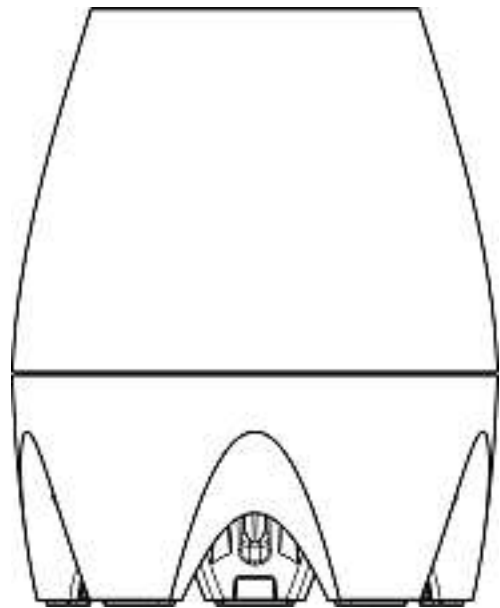

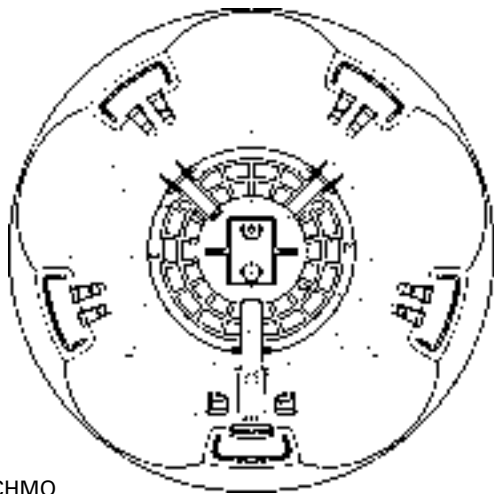

P131CHMO

Cl. 24-99 134 470 12.10.2007
16 Design – Hörgerätebefestigung
Hinterleger: Phonak AG, Laubisrütistrasse 28, 8712 Stäfa
Designer: Jan Angst, Hirzel; Erich Dittli, Reichenburg;
Paul Portmann, Schindellegi; Britta Pukall, Männedorf;
Therese Naef, Wettingen; Florian Wassermann, Zürich
Vertreter: Frei Patentanwaltsbüro AG, 8032 Zürich

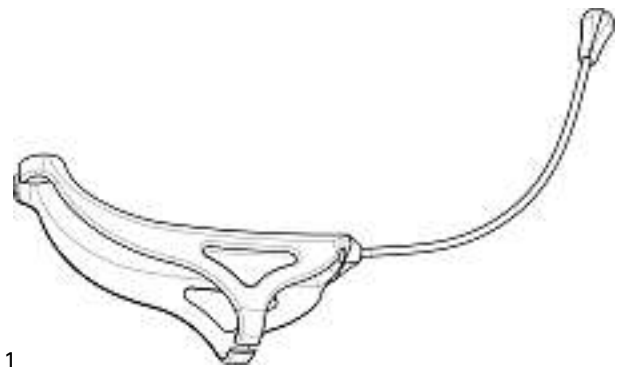
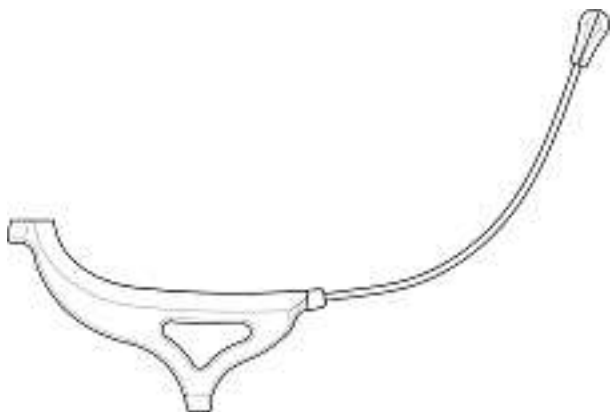
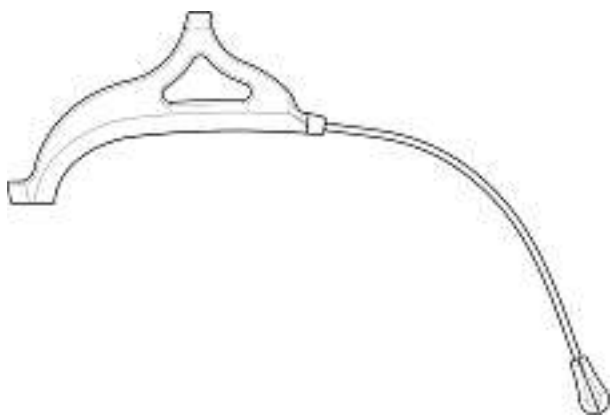
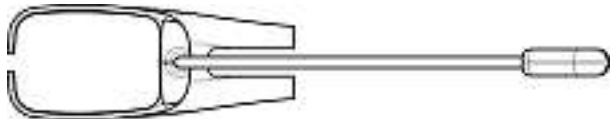
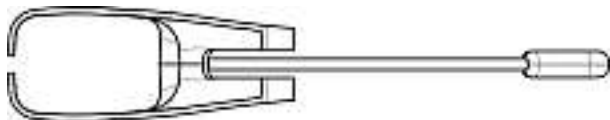

1

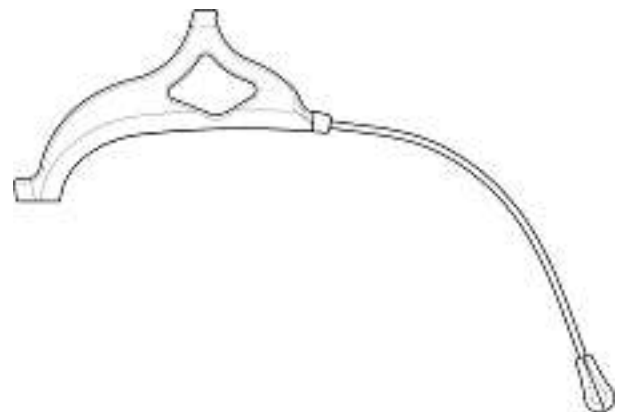
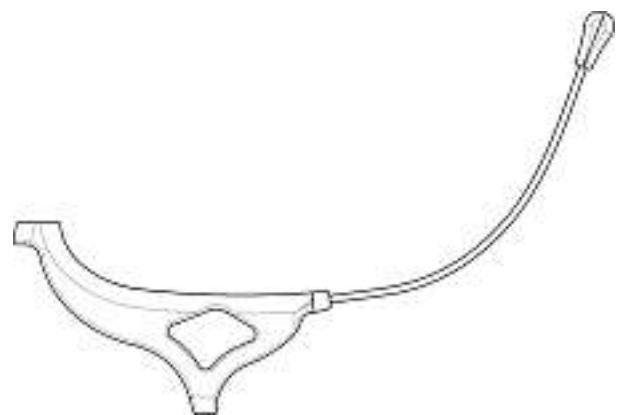
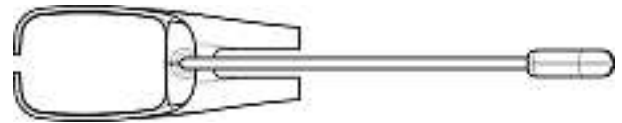
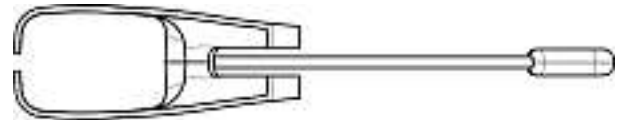
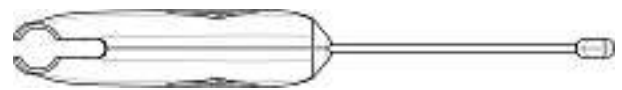

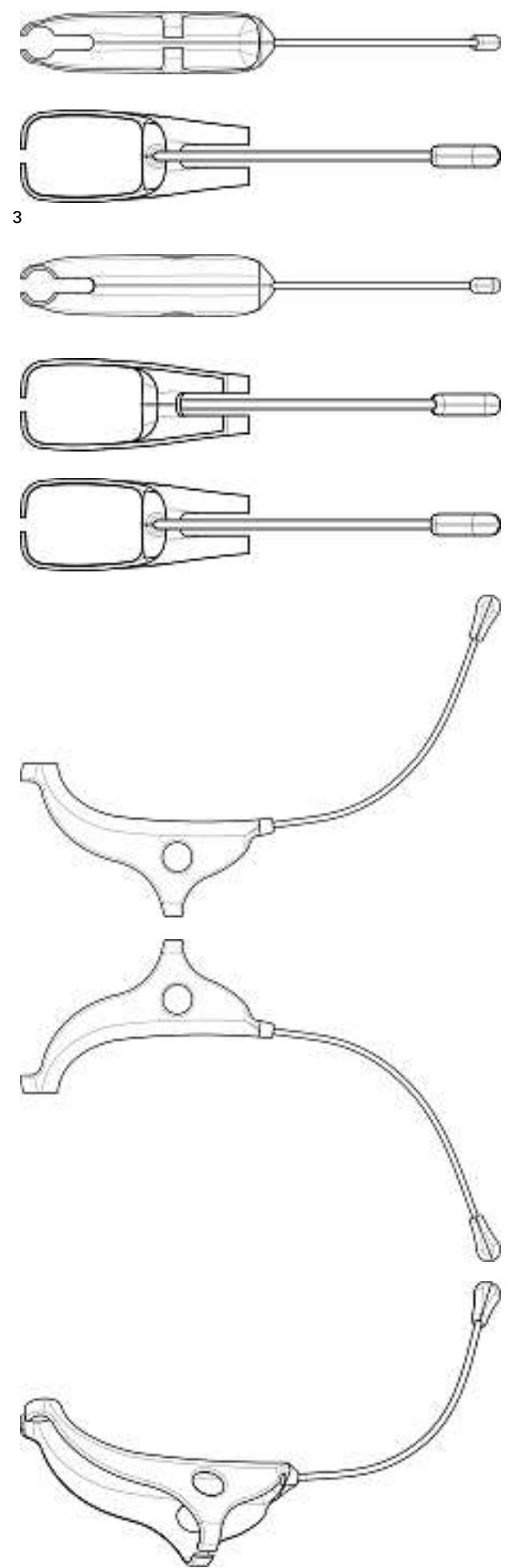
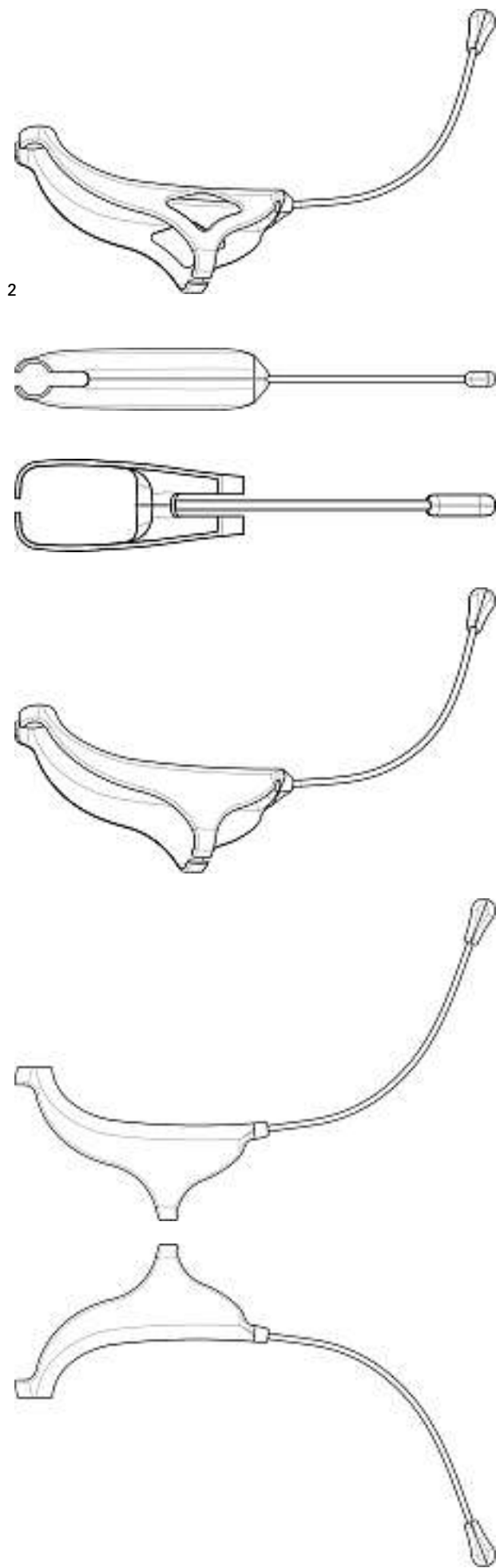



4

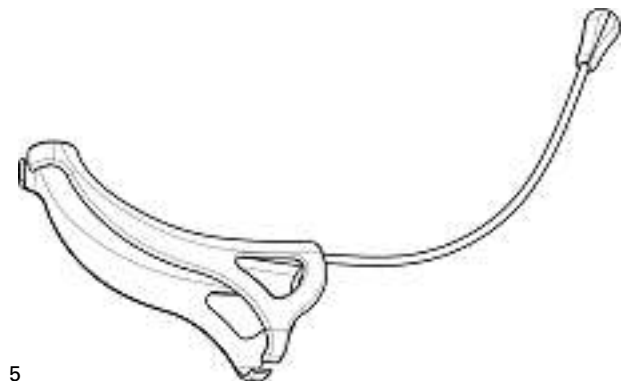
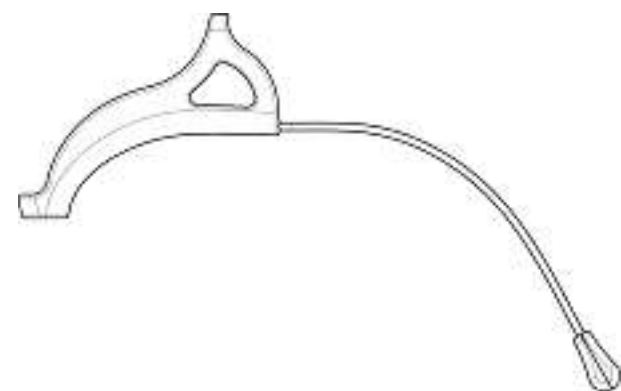
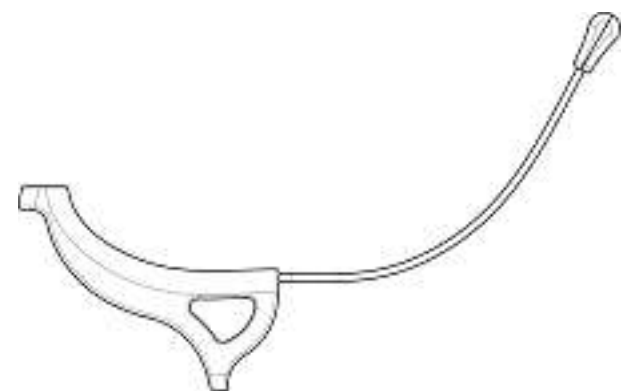
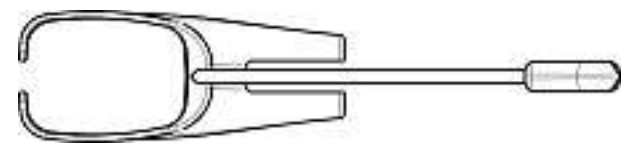
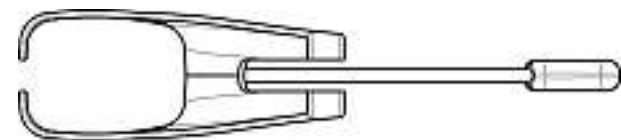
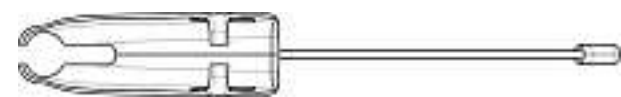
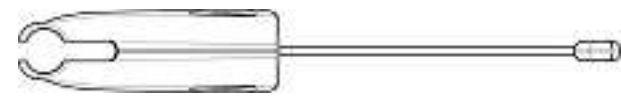

5

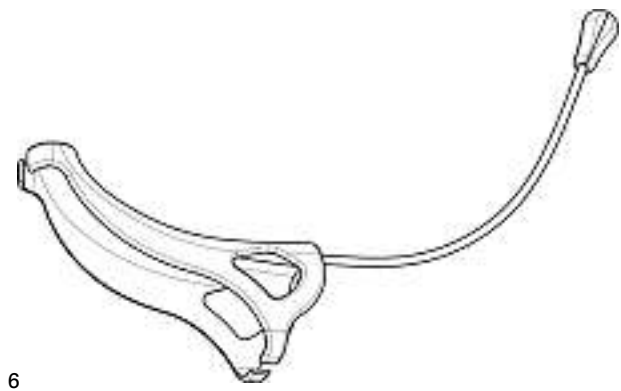
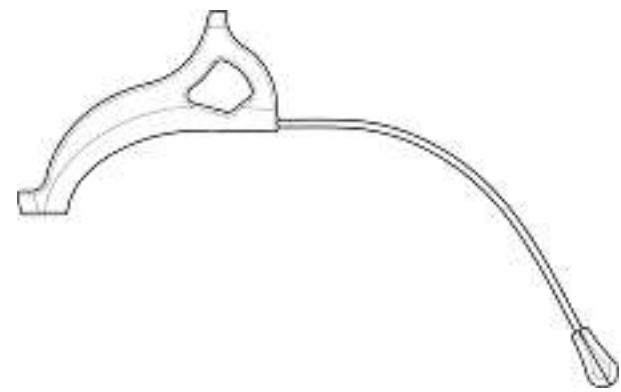
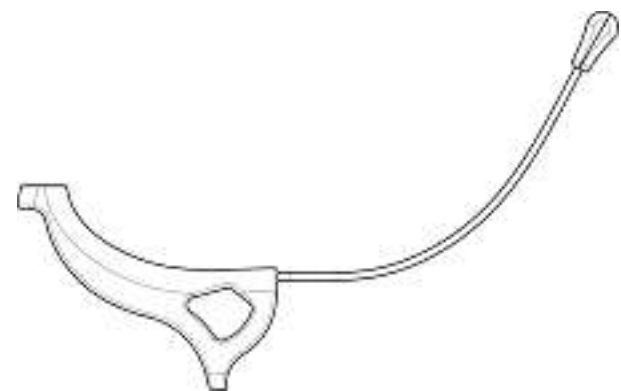
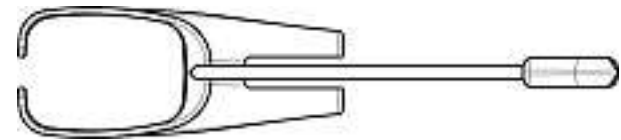
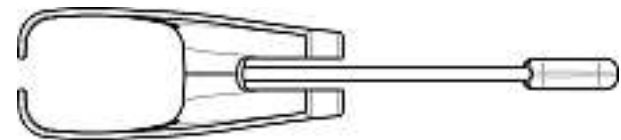
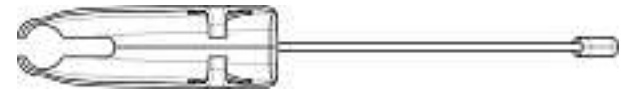
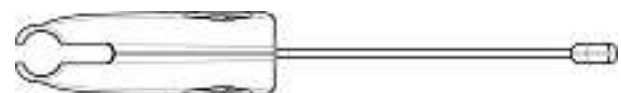

6

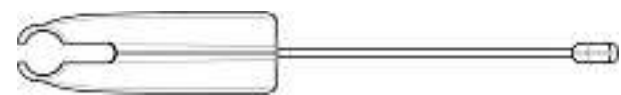

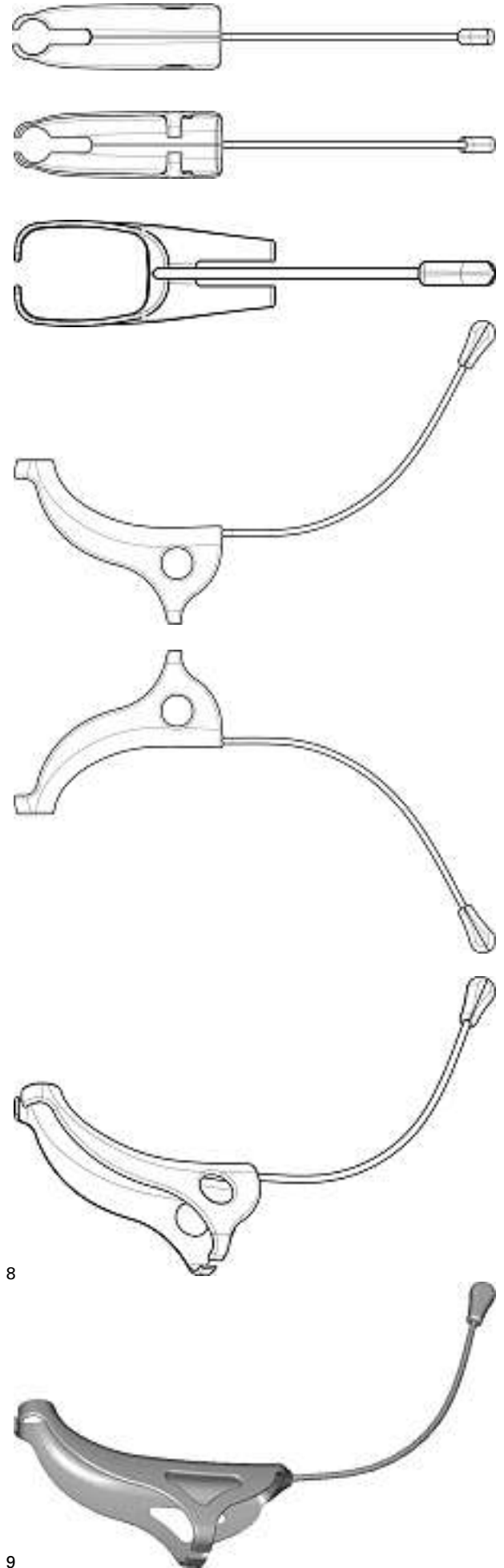
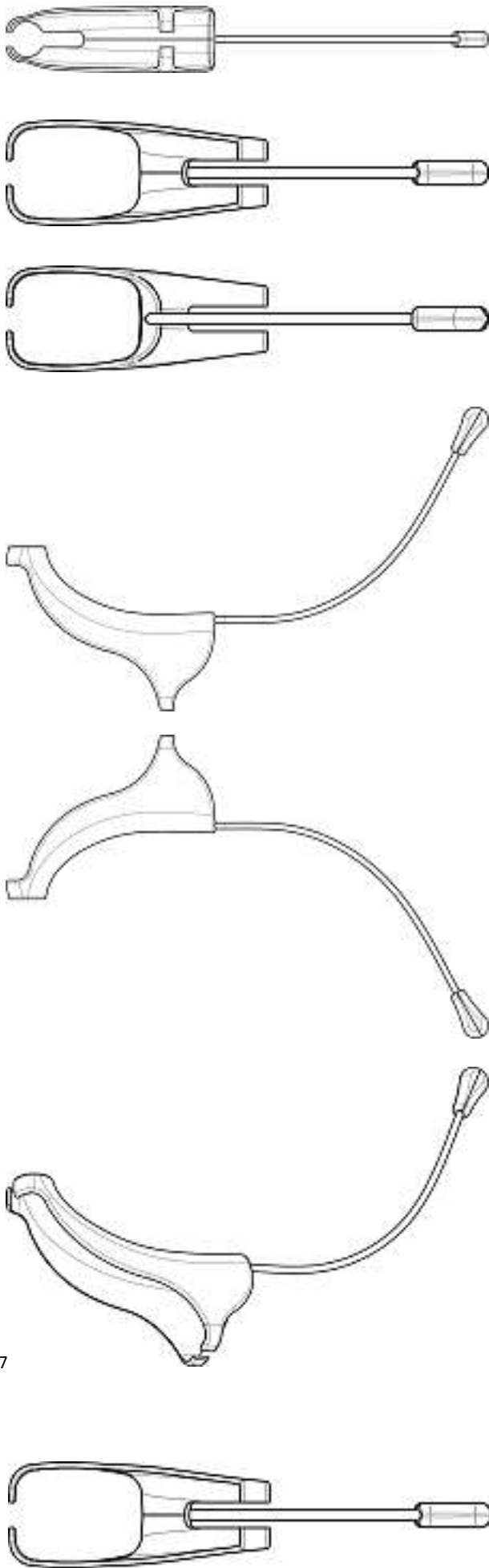

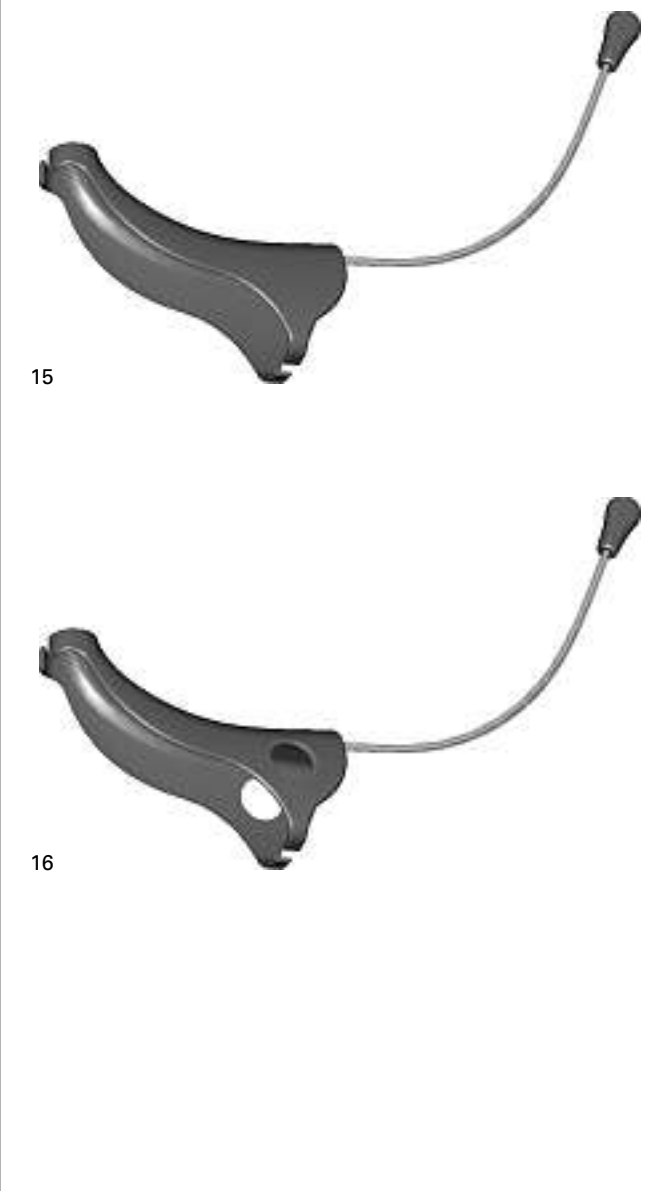
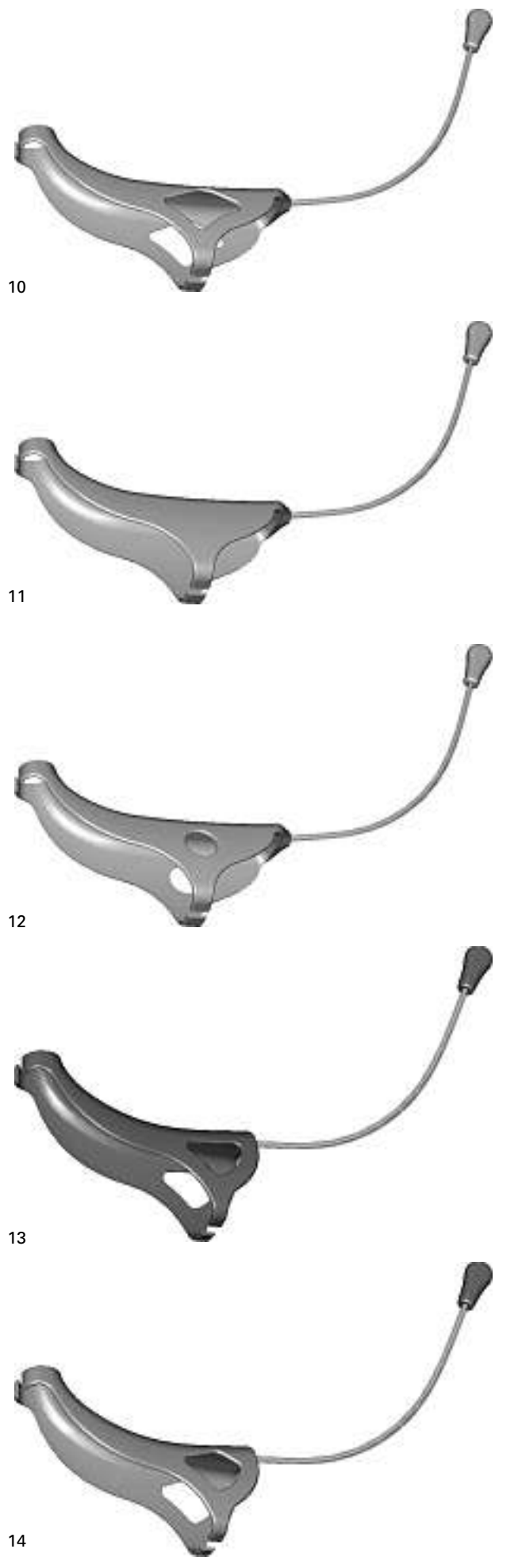

Cl. 26-05 134 471 04.10.2007
1 Design – Lampenschirm
Hinterleger: Alain Jost, Schlachthofstrasse 10, 4056 Basel

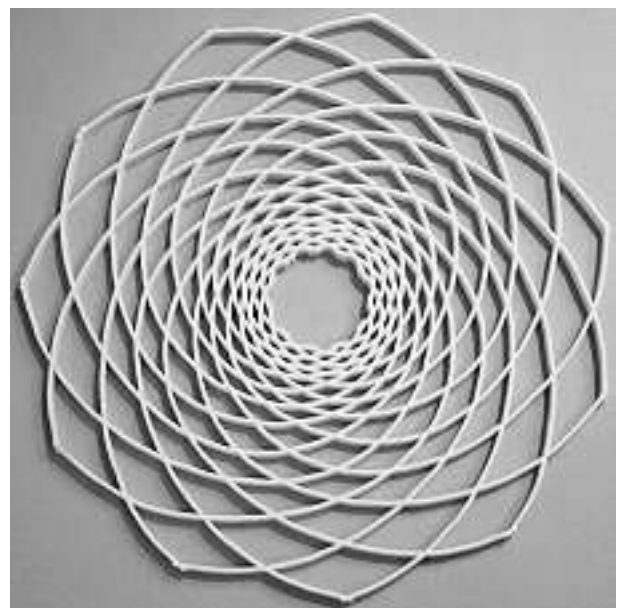

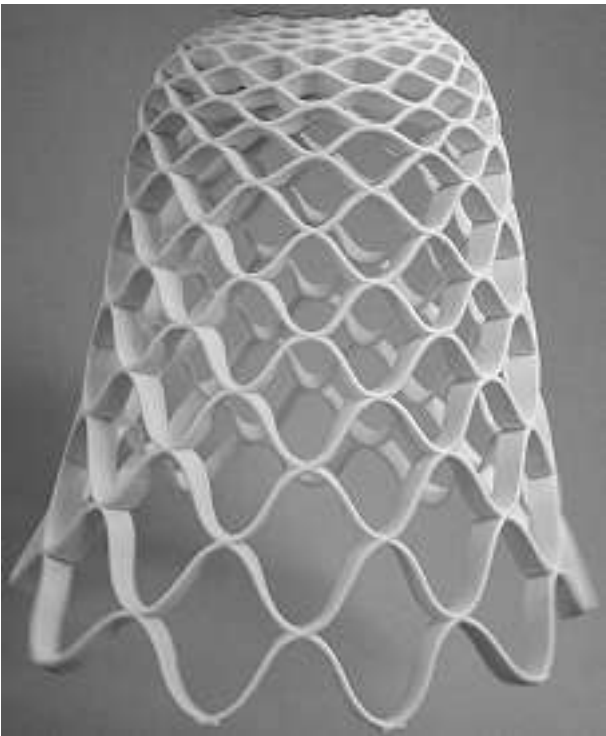

Fibolix

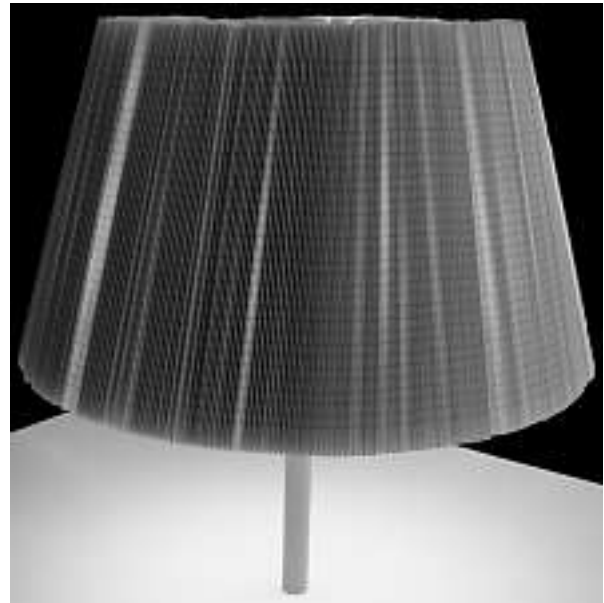

9207

Cl. 26-05 134 472 17.10.2007
 1 Design – Lampe
 Hinterleger: Designrichtung GmbH, Luisenstrasse 25,
 8005 Zürich
 Designer: Jérôme Gessaga, Zürich; Christof Hindermann,
 Zürich

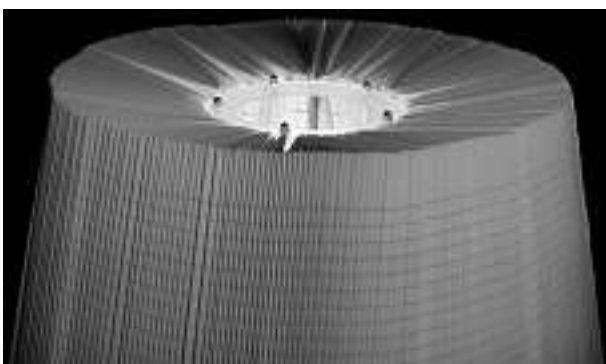
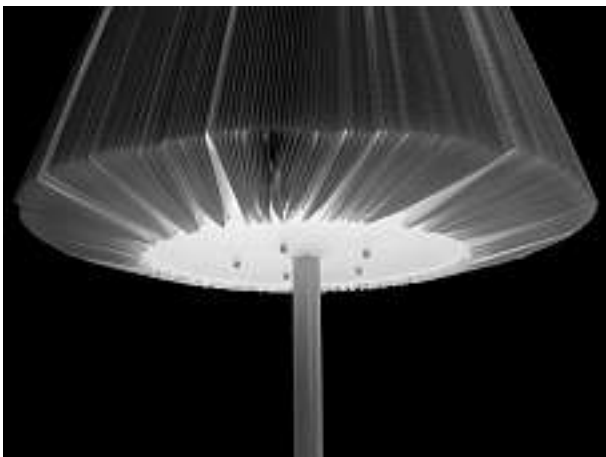

Cl. 26-05 134 473 17.10.2007
 2 Design – Leuchte
 Hinterleger: Zumtobel Lighting GmbH & Co. KG,
 Grevenmarschstrasse 74-78, Lemgo, DE
 Designer: James Irvine, Milano
 Vertreter: A. Braun, Braun, Héritier, Eschmann AG,
 Patentanwälte, 4051 Basel
 Priorität: EM, 17.04.2007

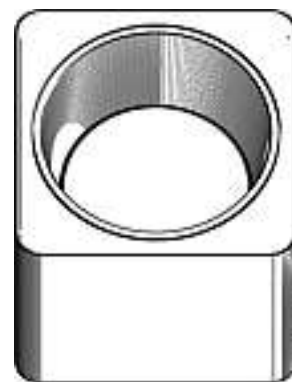



1

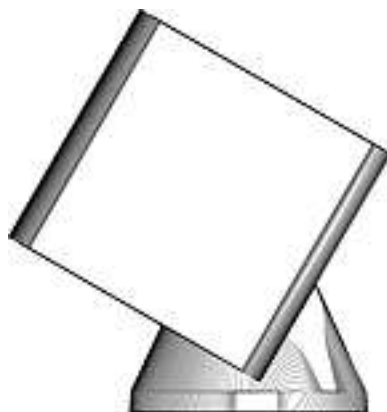
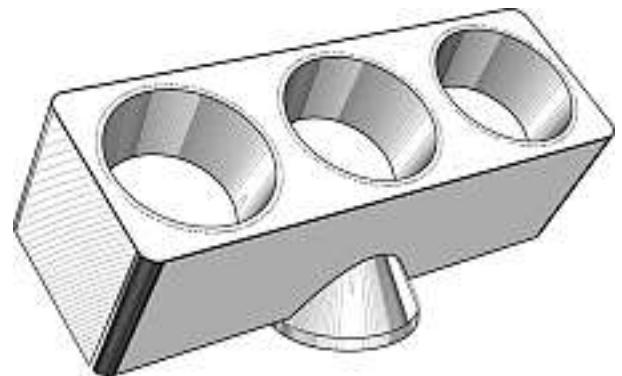
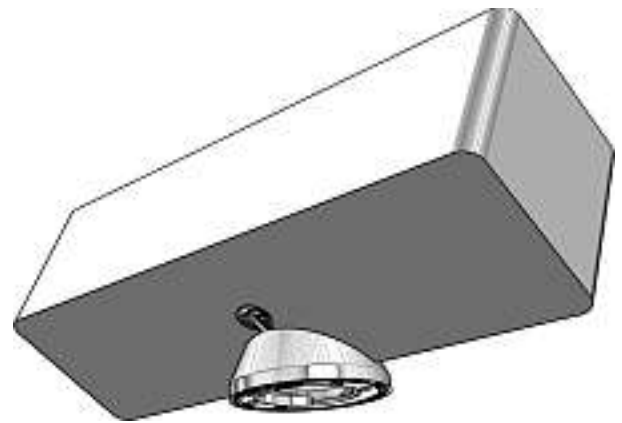
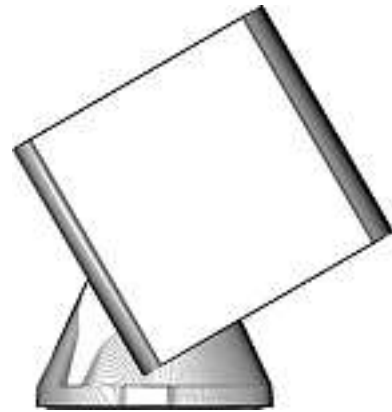

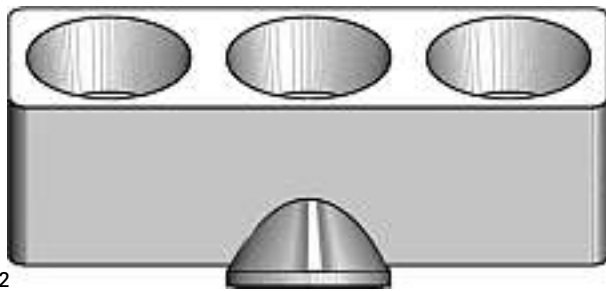
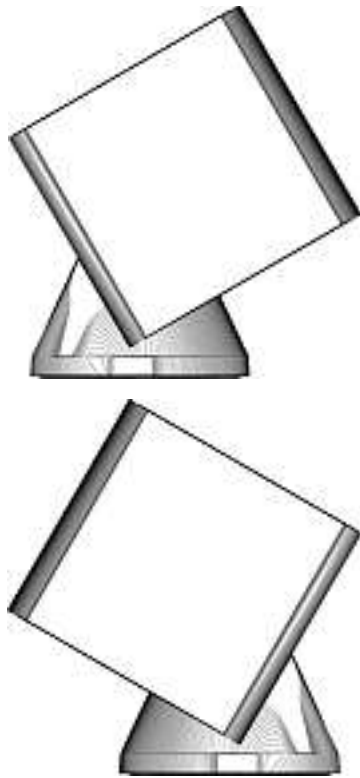

2

Cl. 28-03 **134 474** 03.10.2007
 4 design – dispositif pour le soin des ongles et ses parties
 constitutives
 Déposant: LRC Products Limited, 35 New Bridge Street,
 London EC4V 6BW, GB
 Designer: Craig Wightman, Bristol; Rachel Armstrong, Bristol
 Mandataire: Kirker & Cie S.A., Ingénieurs-Conseils,
 1226 Genève - Thônex
 Priorité: EM, 05.04.2007



1



2





3

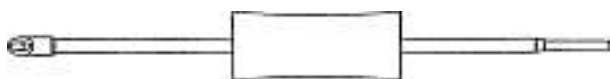
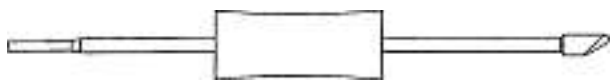

4



Cl. 30-99 134 475 26.09.2007
1 design – ramasse-crotte
Déposant: Lucia Bender, Av. de la Gare 38, 1920 Martigny
Designer: Jacques Pierroz, Martigny



CROBARI

Cl. 31-00 134 476 06.11.2007
1 design – distributeur automatique de boissons
Déposant: Société des Produits Nestlé SA, 1800 Vevey
Designer: John Ashbridge, Leicester
Mandataire: Nestec S.A., 1800 Vevey

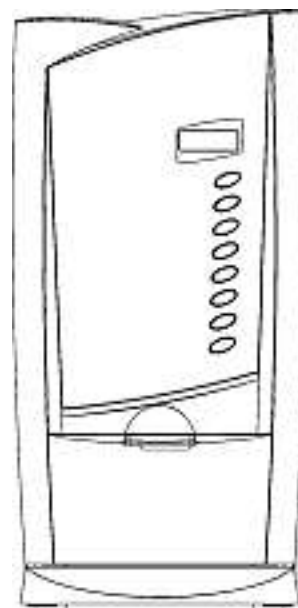
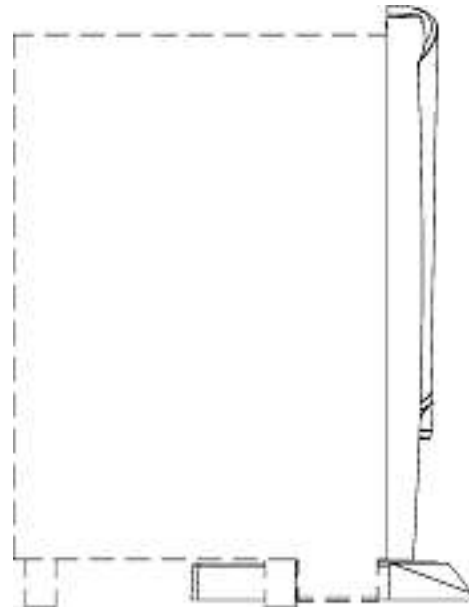
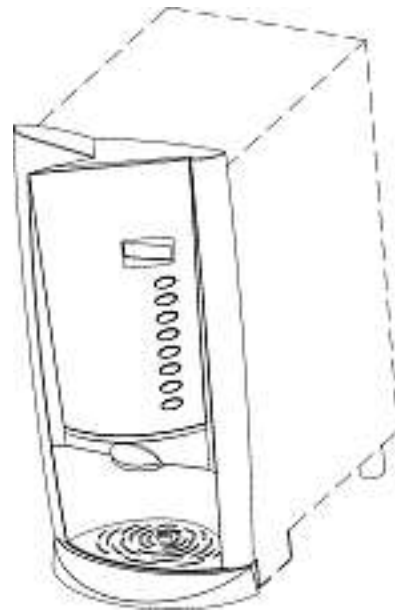

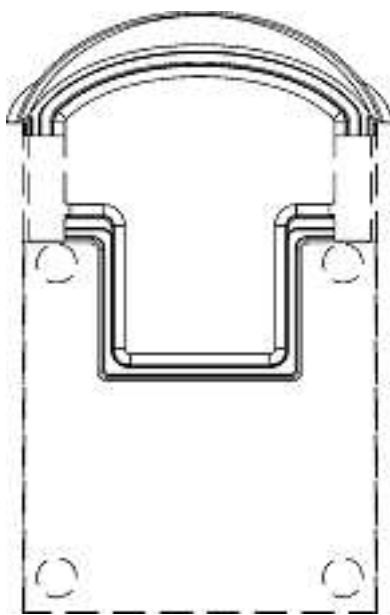
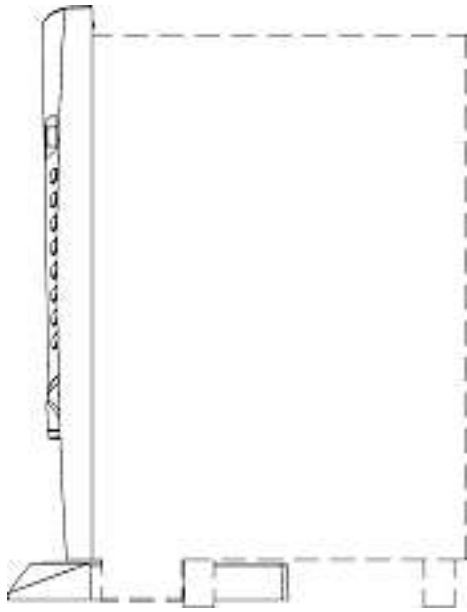

Verlängerungen Prolongations Prolongazioni

| | | | |
|---------|-----|-------|----------|
| 116 379 | Cl. | 09-05 | 1 design |
| 116 388 | Cl. | 13-03 | 2 Design |
| 116 511 | Cl. | 25-02 | 1 Design |
| 120 046 | Cl. | 06-01 | 1 Design |



5

| | | | |
|---------|-----|-------|-----------|
| 124 336 | Cl. | 09-01 | 1 Design |
| 124 337 | Cl. | 09-01 | 1 Design |
| 124 338 | Cl. | 09-01 | 1 Design |
| 124 352 | Cl. | 24-01 | 1 Design |
| 124 353 | Cl. | 24-01 | 1 Design |
| 124 354 | Cl. | 24-01 | 1 Design |
| 124 355 | Cl. | 24-01 | 1 Design |
| 124 356 | Cl. | 24-01 | 1 Design |
| 124 690 | Cl. | 24-02 | 1 Design |
| 124 691 | Cl. | 24-02 | 1 Design |
| 124 754 | Cl. | 14-99 | 2 Design |
| 128 893 | Cl. | 04-02 | 1 Design |
| 129 176 | Cl. | 14-02 | 1 Design |
| 129 180 | Cl. | 16-03 | 1 Design |
| 129 201 | Cl. | 11-01 | 1 design |
| 129 226 | Cl. | 09-01 | 1 Design |
| 129 235 | Cl. | 11-01 | 12 design |
| 129 236 | Cl. | 11-01 | 24 design |
| 129 240 | Cl. | 14-02 | 2 Design |

| | | | |
|---------|-----|-------|----------|
| 129 241 | Cl. | 14-02 | 1 Design |
| 129 242 | Cl. | 14-02 | 1 Design |
| 129 257 | Cl. | 08-08 | 2 Design |
| 129 262 | Cl. | 11-02 | 2 Design |
| 129 265 | Cl. | 14-01 | 1 Design |
| 129 315 | Cl. | 07-04 | 9 Design |
| 129 325 | Cl. | 11-01 | 2 design |
| 129 402 | Cl. | 23-01 | 2 Design |
| 129 412 | Cl. | 02-03 | 1 design |
| 129 455 | Cl. | 06-01 | 5 Design |
| 129 520 | Cl. | 23-01 | 1 Design |
| 129 535 | Cl. | 02-07 | 2 Design |
| 129 542 | Cl. | 06-01 | 3 design |
| 129 547 | Cl. | 06-03 | 1 Design |
| 129 588 | Cl. | 31-00 | 1 Design |

Mutationen Modifications Modificazioni

126 355

Neuer Vertreter
Vertreter: Staiger, Schwald & Partner AG, 8027 Zürich

130 102

Neuer Vertreter
Vertreter: Zimmerli, Wagner & Partner AG, 8001 Zürich

130 676

Transmission
Déposant: Mermod Frères S.A., Rue des Rasses 26a,
1450 Sainte-Croix
Mandataire: Griffes Consulting S.A., 1206 Genève

132 422

Neuer Vertreter
Vertreter: Patentanwalt Dipl.-Ing. (Uni) Wolfgang Heisel,
8570 Weinfelden

132 904

Übertragung
Hinterleger: Setpoint International AG, Industriestrasse,
9475 Sevelen
Vertreter: Rottmann, Zimmermann + Partner AG, 8052 Zürich

134 093

Namensänderung
Hinterleger: nexx.tv Holding GmbH, Westerbachstrasse 32,
61476 Kronberg, DE

134 143

Übertragung
Hinterleger: Associated British Foods plc, Weston Centre,
10 Grosvenor Street, London, W1K 4QY, GB
Vertreter: Niklaus Gadiant, 3001 Bern

Löschungen Radiations Radiazioni

| | | | | |
|---------|-----|-------|----|--------|
| 119 660 | Cl. | 06-01 | 11 | Design |
| 119 669 | Cl. | 09-01 | 2 | Design |
| 124 118 | Cl. | 02-07 | 1 | Design |
| 124 119 | Cl. | 05-03 | 1 | Design |
| 124 132 | Cl. | 09-01 | 4 | Design |
| 124 174 | Cl. | 10-02 | 3 | design |
| 124 176 | Cl. | 10-07 | 2 | design |
| 128 738 | Cl. | 25-03 | 1 | Design |
| 128 744 | Cl. | 06-01 | 1 | Design |
| 128 748 | Cl. | 06-04 | 3 | Design |
| 128 749 | Cl. | 06-04 | 1 | Design |
| 128 751 | Cl. | 07-01 | 1 | Design |
| 128 758 | Cl. | 08-08 | 1 | design |
| 128 759 | Cl. | 09-03 | 16 | Design |
| 128 761 | Cl. | 09-07 | 1 | Design |
| 128 763 | Cl. | 10-02 | 2 | design |
| 128 766 | Cl. | 11-02 | 1 | Design |
| 128 769 | Cl. | 15-03 | 1 | Design |
| 128 776 | Cl. | 26-05 | 4 | design |
| 128 777 | Cl. | 27-05 | 1 | Design |
| 128 778 | Cl. | 99-00 | 21 | Design |
| 128 808 | Cl. | 24-04 | 17 | Design |
| 128 811 | Cl. | 03-01 | 1 | design |
| 128 812 | Cl. | 03-01 | 1 | design |
| 128 840 | Cl. | 12-13 | 1 | design |
| 128 850 | Cl. | 24-04 | 2 | design |
| 128 860 | Cl. | 02-03 | 3 | Design |
| 128 868 | Cl. | 07-02 | 3 | Design |
| 128 878 | Cl. | 22-99 | 2 | Design |

Berichtigungen
Rectifications
Rettifiche

131 951
Berichtigung des Designers
Martin Iseli, Bern