

Nationale Hinterlegungen

In der folgenden Liste werden die beim Eidgenössischen Institut für Geistiges Eigentum hinterlegten Designs publiziert. Dabei sind der Reihe nach angegeben:

- internationale Klassenangaben
- Hinterlegungsnummer
- Hinterlegungsdatum
- Allenfalls Aufschub der Veröffentlichung
- Anzahl der hinterlegten Designs
- Bezeichnung
- Name und Wohnsitz des Hinterlegers oder der Hinterlegerin
- gegebenenfalls Name und Wohnsitz des Designers oder der Designerin
- Name und Geschäftssitz des allfälligen Vertreters oder der Vertreterin
- gegebenenfalls Prioritätsangaben
- gegebenenfalls Beschreibungstext
- Ordnungsnummer
- Reproduktion des Designs

Internationale Hinterlegungen

Die bei der Weltorganisation für geistiges Eigentum in Genf hinterlegten Muster und Modelle mit Benennung Schweiz geniessen den gleichen Schutz wie national hinterlegte Designs. Sie werden jeweils im Blatt «Bulletin des dessins et modèles internationaux» veröffentlicht. Dieses Publikationsorgan ist deshalb für eine vollständige Recherche unbedingt beizuziehen.

Topographien

Angaben über die vom Eidgenössischen Institut für Geistiges Eigentum eingetragenen Topographien von Halbleitererzeugnissen werden in folgender Anordnung aufgeführt:

- Eintragungsnummer
- Anmeldedatum
- Bezeichnung
- Name und Wohnsitz des Anmelders oder der Anmelderin
- gegebenenfalls Name und Wohnsitz des Herstellers oder der Herstellerin
- Name und Geschäftssitz des oder der allfälligen Bevollmächtigten
- Datum und Ort einer allfälligen ersten geschäftlichen Verbreitung der Topographie

Dépôts nationaux

Les designs déposés à l'Institut Fédéral de la Propriété Intellectuelle sont publiés dans la liste qui suit. Les indications y relatives sont mentionnées dans cet ordre:

- indications des classes internationales
- numéro de dépôt
- date de dépôt
- le cas échéant, ajournement de la publication
- nombre des designs déposés
- désignation
- nom et domicile du/de la déposant/e
- le cas échéant, nom et domicile du/de la designer
- nom et domicile de l'éventuel/le mandataire
- le cas échéant, indication de priorité
- le cas échéant, description du design
- numéro attribué à chaque design
- reproduction du design

Dépôts internationaux

Les dessins et modèles déposés à l'Organisation Mondiale de la Propriété Intellectuelle à Genève qui désignent la Suisse jouissent de la même protection que les dépôts nationaux. Ils sont chaque fois publiés dans la feuille «Bulletin des dessins et modèles internationaux». Pour une recherche complète, il est indispensable de consulter ledit organe de publication.

Topographies

Les indications concernant les topographies des produits semi-conducteurs, enregistrées par l'Institut Fédéral de la Propriété Intellectuelle, sont énumérées dans l'ordre suivant:

- numéro d'enregistrement
- date de dépôt
- désignation
- nom et domicile du/de la déposant/e
- le cas échéant, nom et domicile du/de la producteur/trice
- nom et domicile de l'éventuel/le mandataire
- date et lieu d'une éventuelle première mise en circulation de la topographie

Depositi nazionali

Nella lista seguente vengono pubblicati i design depositati presso l'Istituto Federale della Proprietà Intellettuale. Sono menzionati nel seguente ordine:

- indicazioni delle classi internazionali
- numero di deposito
- data del deposito
- se del caso, indicazione che la pubblicazione è stata differita
- numero dei design depositati
- designazione
- nome e domicilio del depositante
- se del caso, nome e domicilio del designer
- nome e sede di un eventuale mandataro
- se del caso, indicazioni di priorità
- se del caso, descrizione del design
- numero d'ordine
- riproduzione del design

Depositi internazionali

I disegni e modelli depositati presso l'Organizzazione Mondiale della Proprietà Intellettuale a Ginevra con denominazione Svizzera godono della medesima protezione del deposito nazionale. Essi vengono pubblicati ogni volta nel foglio «Bulletin des dessins et modèles internationaux». Quest'organo di pubblicazione è da consultare se si vuole effettuare una ricerca completa.

Topografie

Le indicazioni concernenti le topografie di prodotti a semiconduttori depositati presso l'Istituto Federale della Proprietà Intellettuale sono menzionate nell'ordine seguente:

- numero di registrazione
- data del deposito
- designazione
- nome e domicilio del/la richiedente
- se del caso, nome e domicilio del/la produttore/trice
- nome e sede di un eventuale mandataro
- data e luogo di un'eventuale prima messa in circolazione della topografia

**Hinterlegungen
Dépôts
Deposit**

Cl. 23-01 133 163 20.09.2006
3 Design – Armaturen
Hinterleger: KWC AG, Hauptstrasse 57, 5726 Unterkulm
Designer: Daniel Kübler, Zürich
Vertreter: Patentanwälte, Schaad, Balass, Menzl & Partner AG,
8034 Zürich
Ende aufgeschobene Publikation:



1







3

Cl. 10-07 133 342 23.11.2006
 4 design – boîtiers de montre, montre, cadran pour montre
 Déposant: Pierre-André Finazzi, 17, rue du Commerce,
 2300 La Chaux-de-Fonds
 Mandataire: Griffes Consulting S.A., 1206 Genève
 Fin de la période ajournement de la publication:

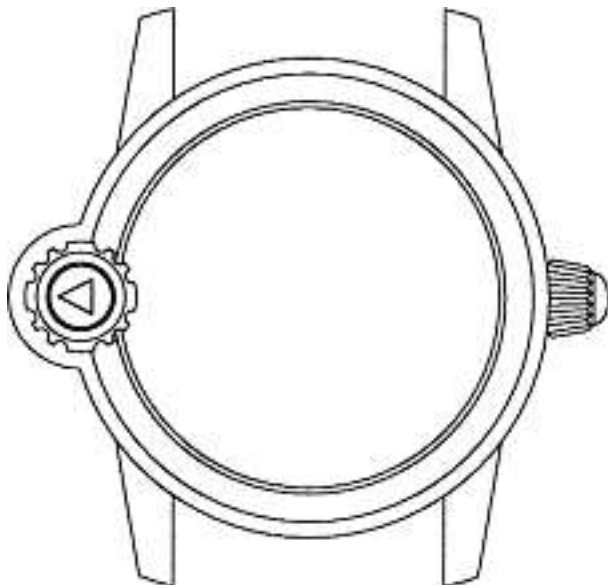

5998-MO-0002-CH-CH-01



5998-MO-0003-CH-CH-01

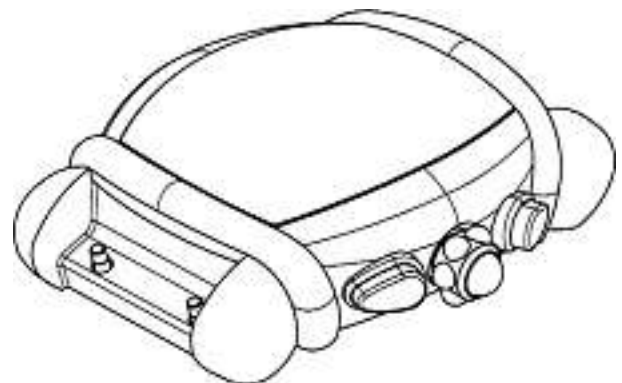
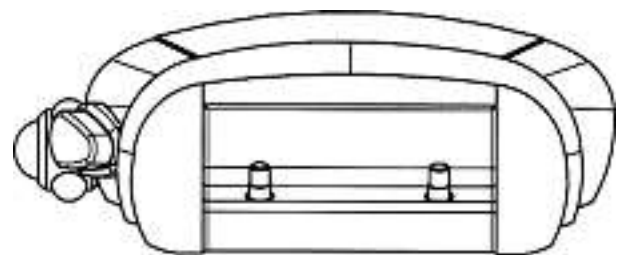
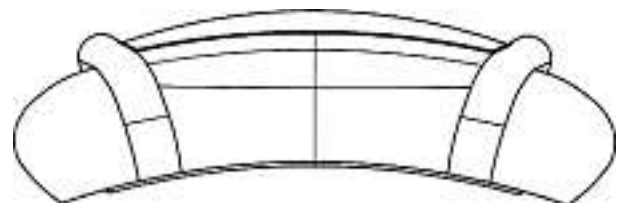
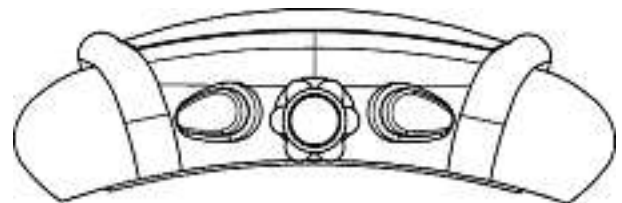

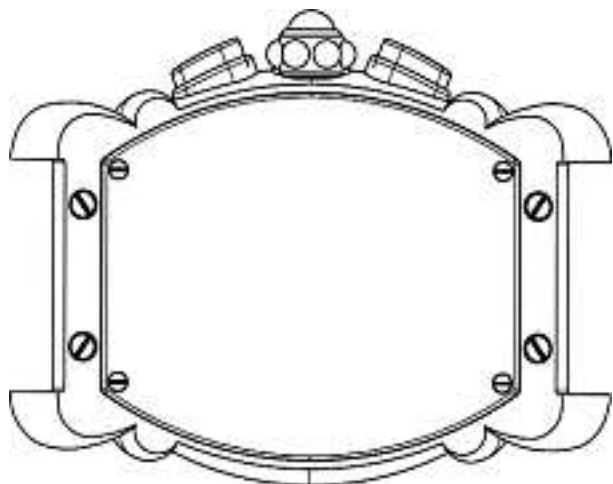
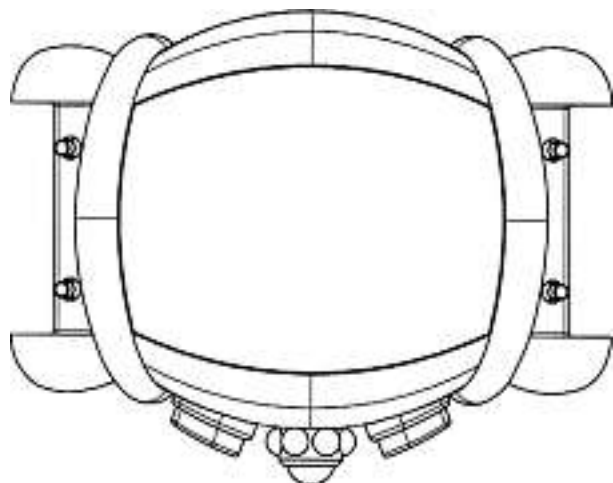
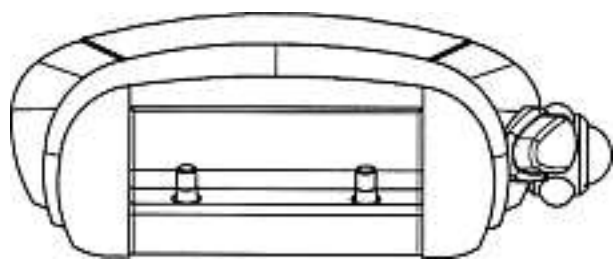

5998-MO-0004-CH-CH-01

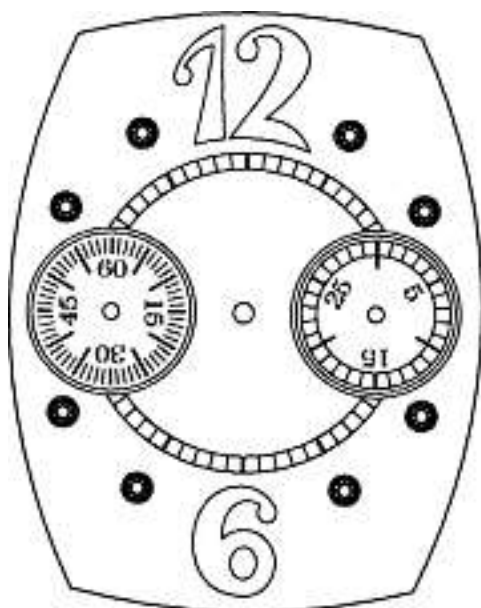

5998-MO-0005-CH-CH-01

Cl. 10-07 133 648 15.02.2007
 5 design – boîtier de montre, cadran de montre, montre,
 aiguilles pour montre
 Déposant: Pierre-André Finazzi, 17, rue du Commerce,
 2300 La Chaux-de-Fonds
 Mandataire: Griffes Consulting S.A., 1206 Genève
 Fin de la période d'ajournement de la publication:

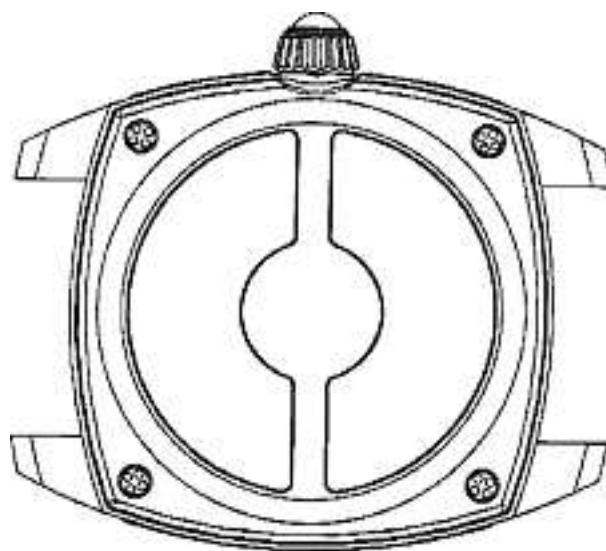
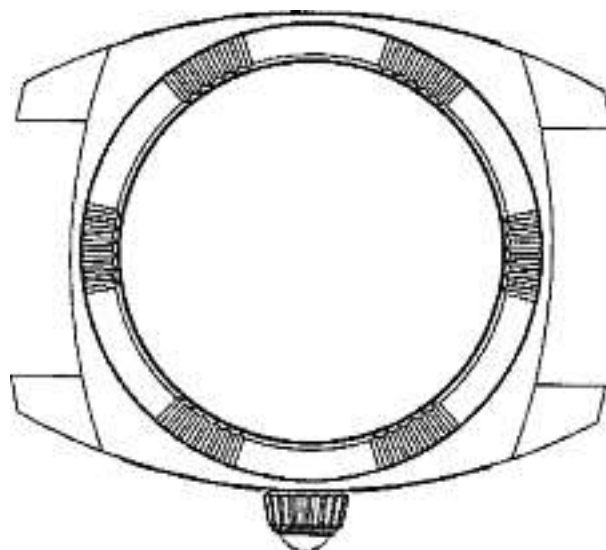
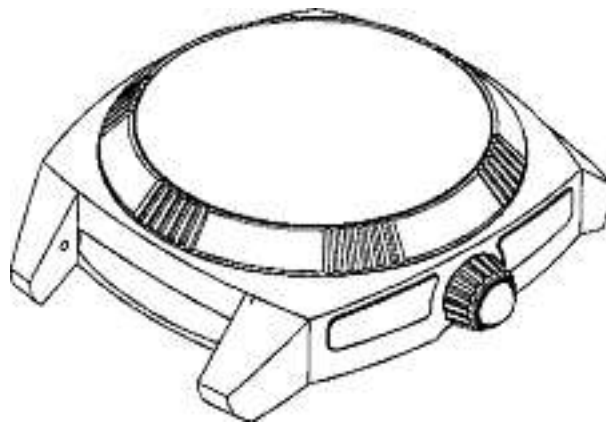

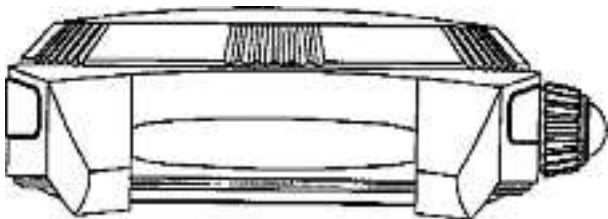
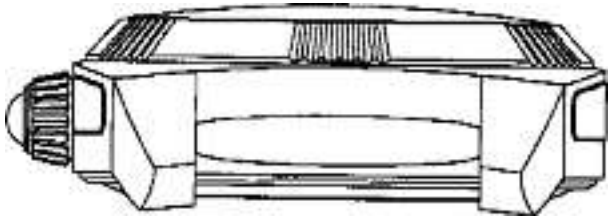
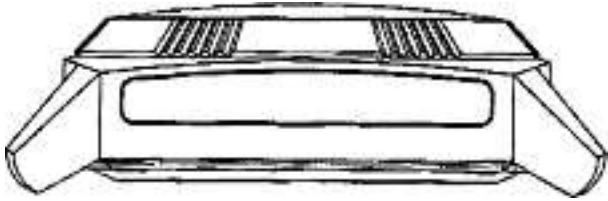
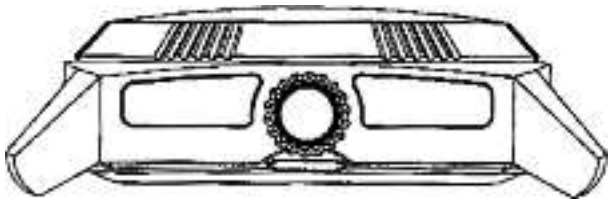

5998-MO-0007-CH-CH-01



5998-MO-0009-CH-CH-01

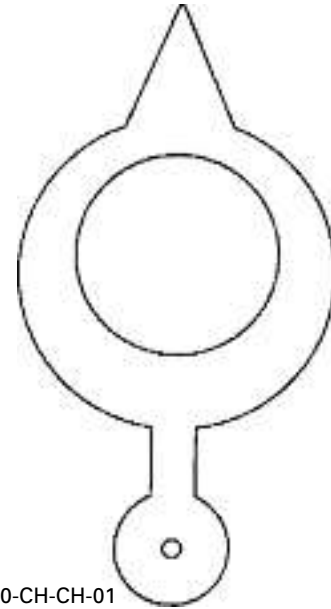

5998-MO-0010-CH-CH-01

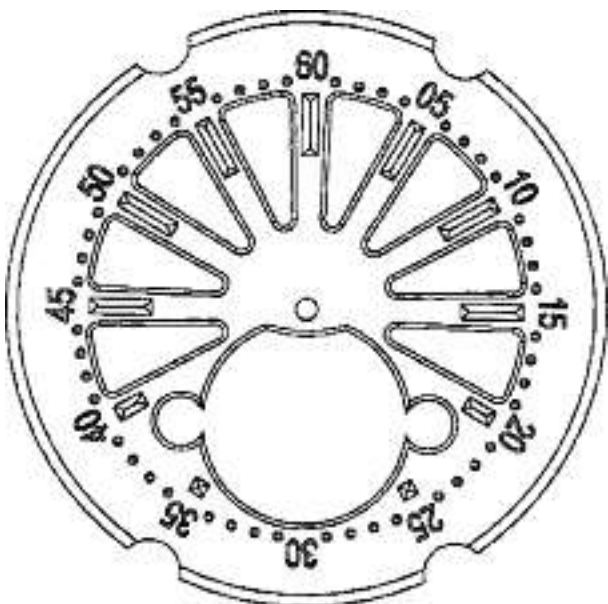

5998-MO-0008-CH-CH-01



5998-MO-0011-CH-CH-01

Cl. 23-01 133 696 23.02.2007
1 Design – Armatur
Hinterleger: KWC AG, Hauptstrasse 57, 5726 Unterkulm
Designer: Michael Lammel, Aachen; Michael Zeisel, Aachen
Vertreter: Patentanwälte, Schaad, Balass, Menzl & Partner AG,
8034 Zürich
Ende aufgeschobene Publikation:





1

Cl. 23-01 **133 697** 27.02.2007
 3 Design – Armaturen
 Hinterleger: KWC AG, Hauptstrasse 57, 5726 Unterkulm
 Designer: Michael Lammel, Aachen; Michael Zeisel, Aachen
 Vertreter: Patentanwälte, Schaad, Balass, Menzl & Partner AG, 8034 Zürich
 Ende aufgeschobene Publikation:
 1 (siehe Farbteil Heftmitte)
 2 (siehe Farbteil Heftmitte)
 3 (siehe Farbteil Heftmitte)

Cl. 02-02 **133 972** 05.06.2007
 13 Design – Sportbekleidung
 Hinterleger: Odlo International AG, Im Bösch 67, 6331 Hünenberg
 Designer: Bettina Albiez, Zug; Sarah Ginet, Bourg St. Maurice; Zoe Gilbertson, Nürnberg
 Vertreter: Frei Patentanwaltsbüro AG, 8032 Zürich
 Ende aufgeschobene Publikation:



1



2



3



4

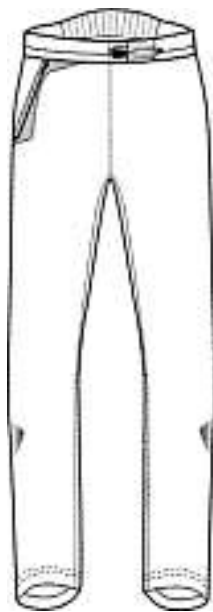

5

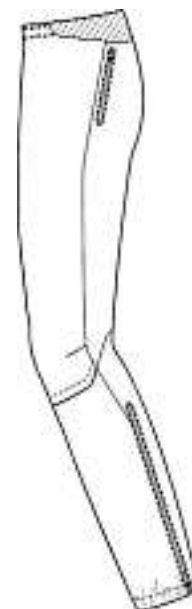
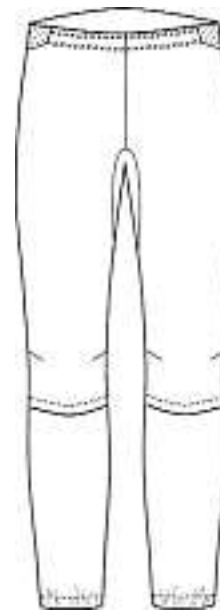

6

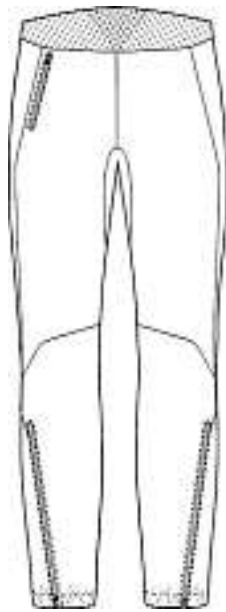

7

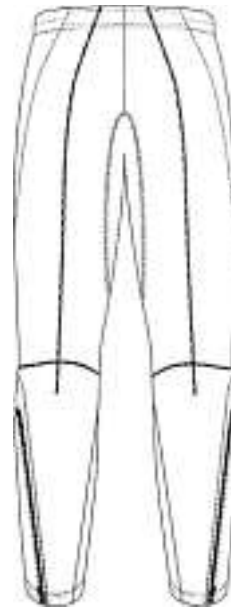

8



9



10



11



12



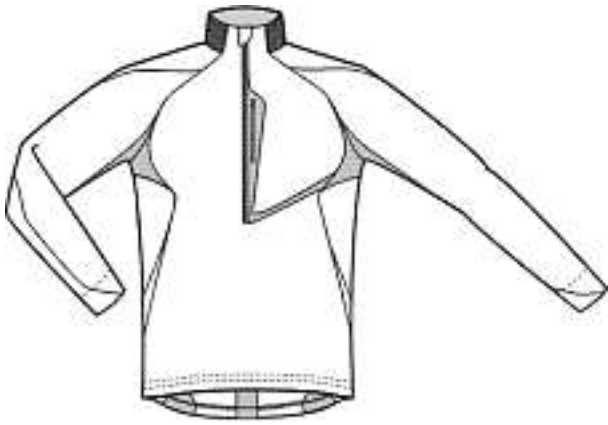

13

Cl. 03-01 134 477 17.10.2007
 1 Design – Tasche
 Hinterleger: Minka Dizdar, Länggasse 9b, 3600 Thun
 Beschreibung des Designs: Tasche mit Reissverschluss und stabilem Boden.



1

Cl. 03-01 134 478 31.10.2007
 1 Design – Spielbehälter
 Hinterleger: mako.ch Matthias Kost, Baarerstrasse 79,
 6300 Zug
 Designer: Matthias Kost, Brüttisellen





Jassbox

Cl. 06-01 134 480 25.10.2007
 1 Design – Melkstuhl
 Hinterleger: Adelrich Uhr, Fröschlezenstrasse 22,
 8340 Hinwil



Käsemelkstuhl

Cl. 06-01, 06-03 134 481 30.10.2007
 13 Design – Sofas, Tische
 Hinterleger: 1A Brands Handels GmbH, Oberdorfstrasse 38,
 4244 Röschenz
 Designer: Jan Horni, Röschenz

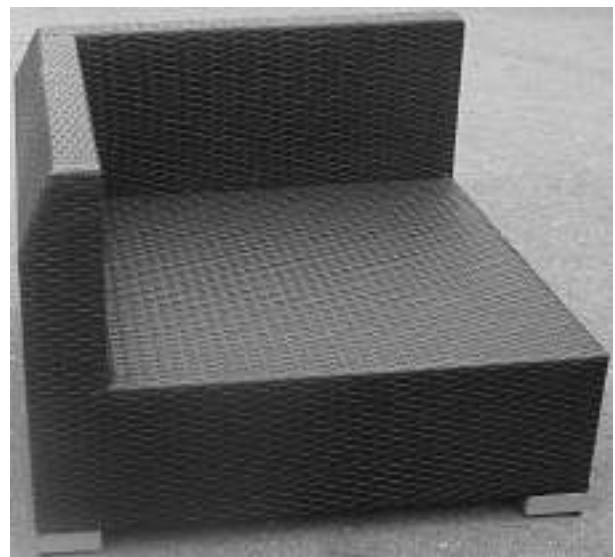
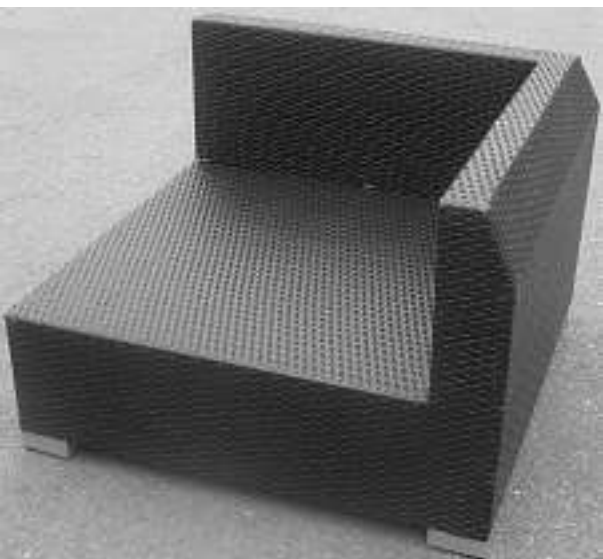

1

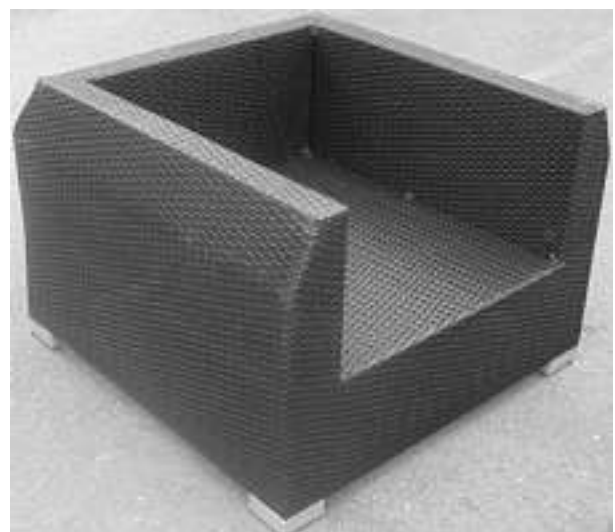
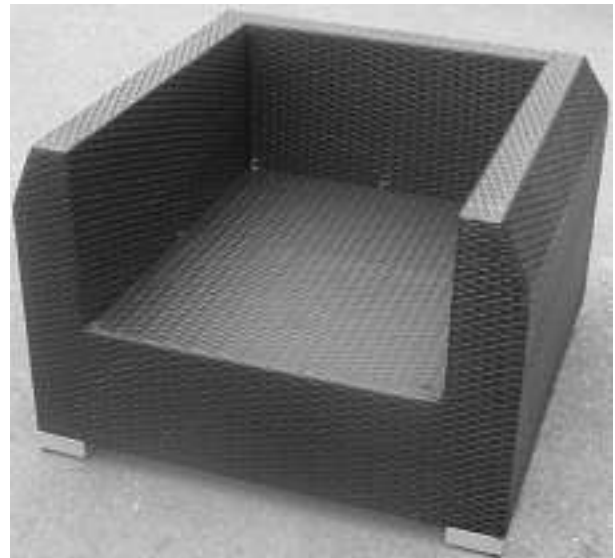

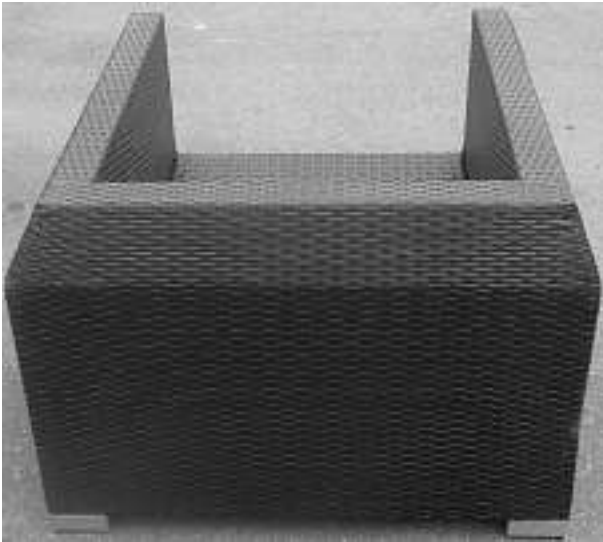

2

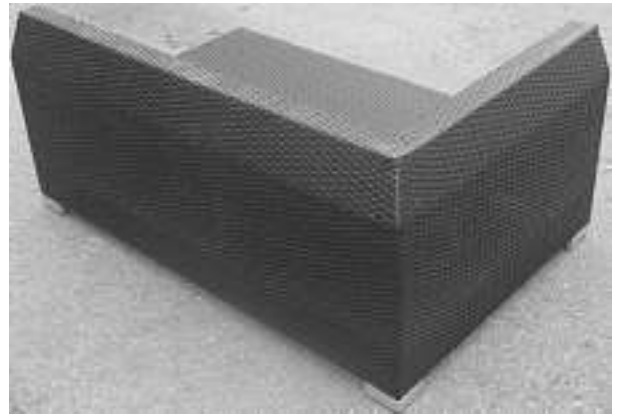

3

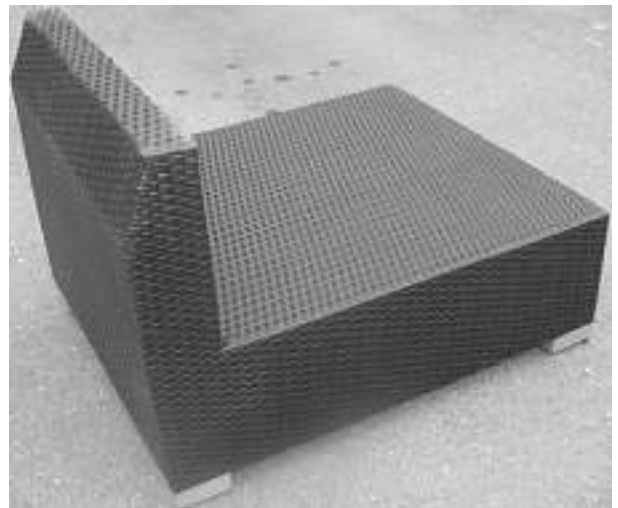
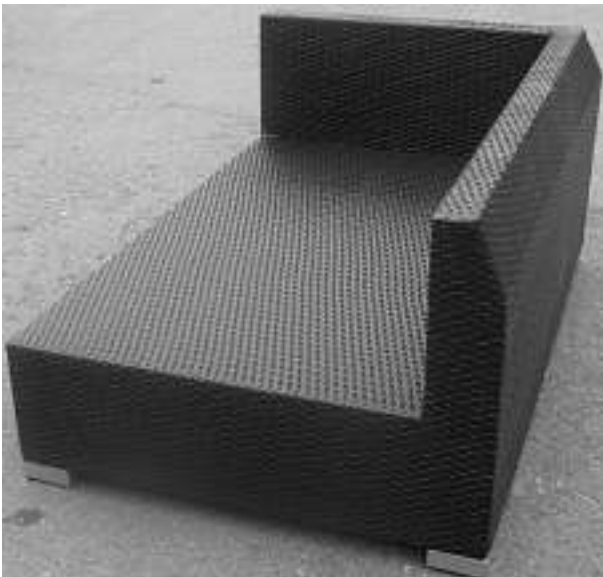
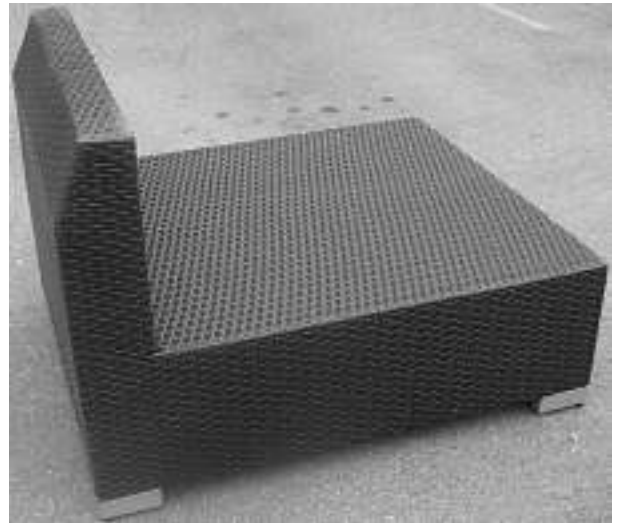
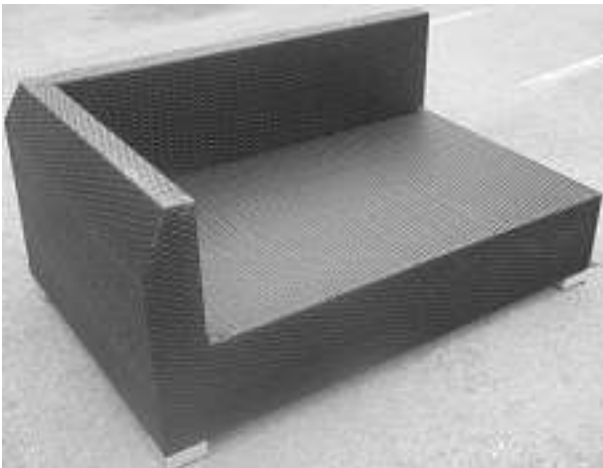

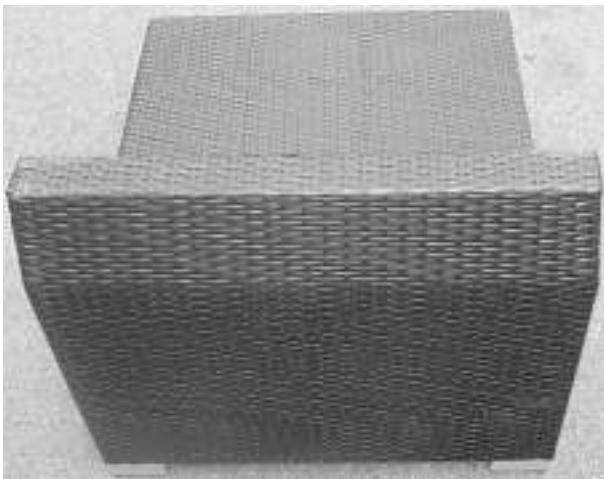

4



5



6

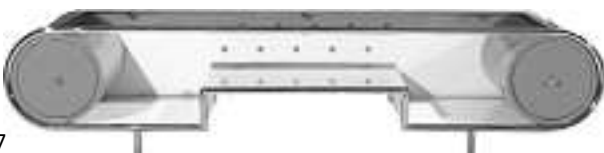

7



8



9

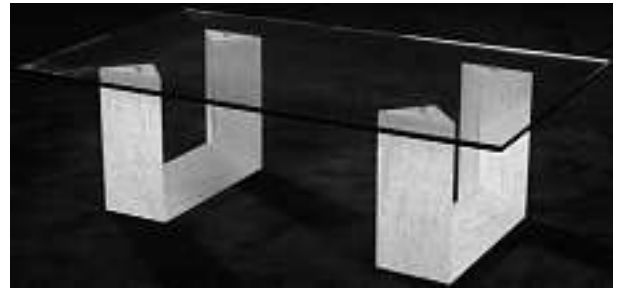

10



11



12



13

Cl. 06-01 134 482 06.11.2007

3 Design – Therapie-Liegen
 Hinterleger: Markus Stutz, Rütistrasse 7, Quartier Hasler,
 8903 Birmensdorf-Waldegg
 Vertreter: Isler & Pedrazzini AG, 8027 Zürich

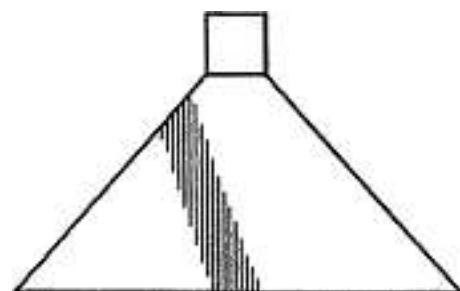

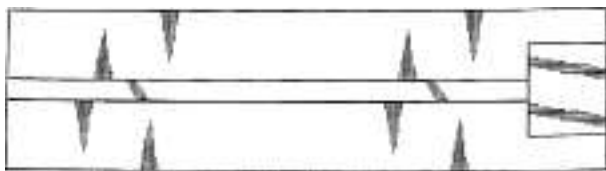
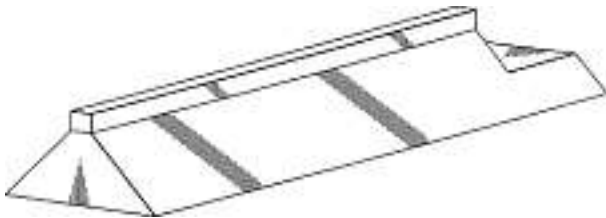
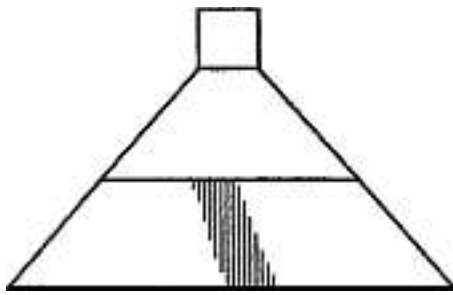

M13422-1

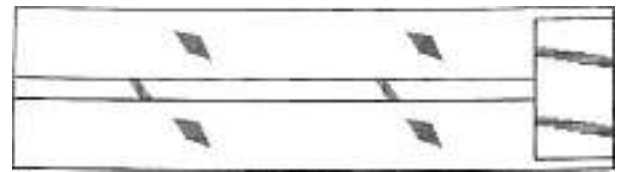
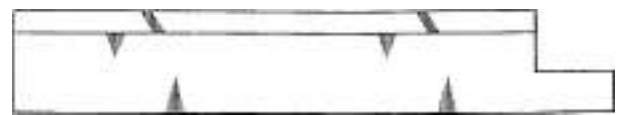
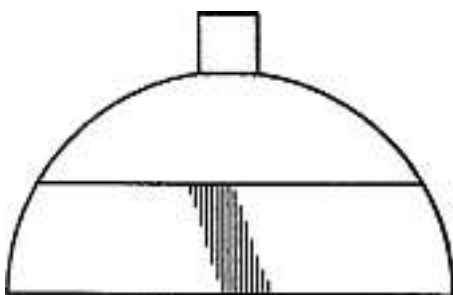
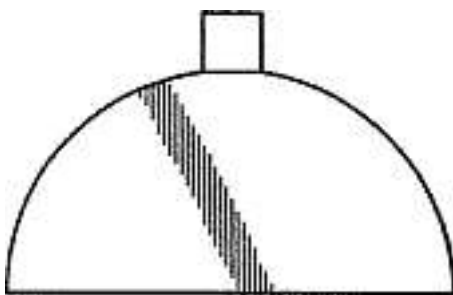
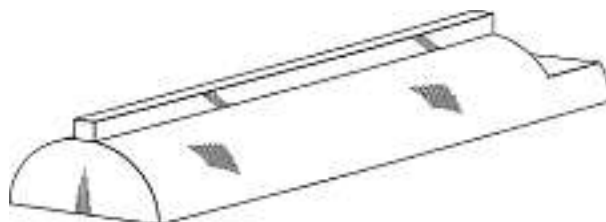

M13422-2

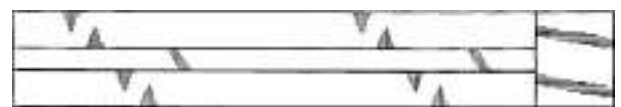
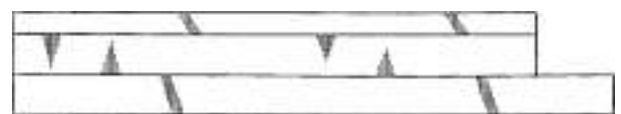
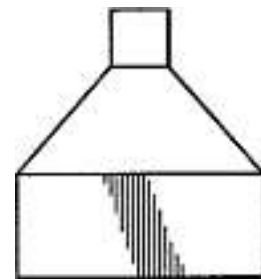
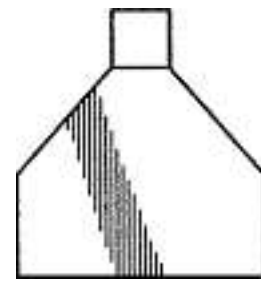
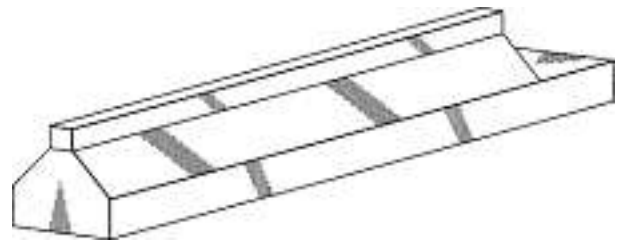

M13422-3

Cl. 06-03, 06-04 **134 483** 22.10.2007
 2 Design – Sideboard, Tisch
 Hinterleger: John Bär, Rapperswilerstrasse 20A, 8630 Rüti ZH



Board 1



Board 2

Cl. 06-03 **134 484** 25.10.2007
 1 Design – Tisch
 Hinterleger: Beat Huwyler, Elekraweg 2, 5034 Suhr



RV11

Cl. 07-01 **134 485** 23.10.2007
 2 Design – Trinkgefäße
 Hinterleger: Pi-Design AG, Kantonsstrasse 100,
 6234 Triengen
 Designer: Jørgen Bodum, Meggen
 Vertreter: Isler & Pedrazzini AG, 8027 Zürich
 Priorität: DK, 25.04.2007



M13418-1

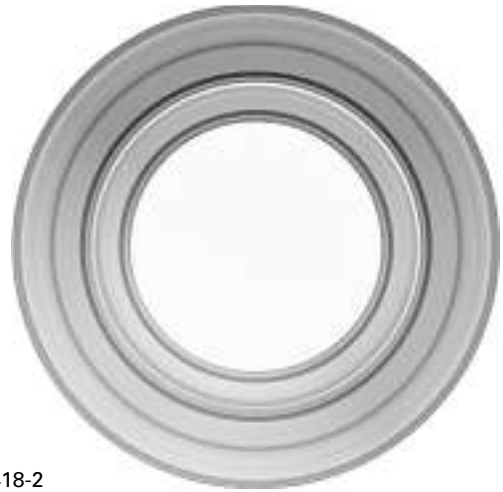

M13418-2

Cl. 07-01 **134 486** 29.10.2007
2 Design – Trinkgefäß
Hinterleger: Pi-Design AG, Kantonsstrasse 100,
6234 Triengen
Designer: Jørgen Bodum, Meggen
Vertreter: Isler & Pedrazzini AG, 8027 Zürich
Priorität: DK, 08.05.2007





M13424-1



M13424-2

Cl. 07-01 **134 487** 31.10.20072 Design – Getränkekrug
Hinterleger: Pi-Design AG, Kantonsstrasse 100,
6234 TriengenDesigner: Jørgen Bodum, Meggen
Vertreter: Isler & Pedrazzini AG, 8027 Zürich
Priorität: DK, 05.10.2007

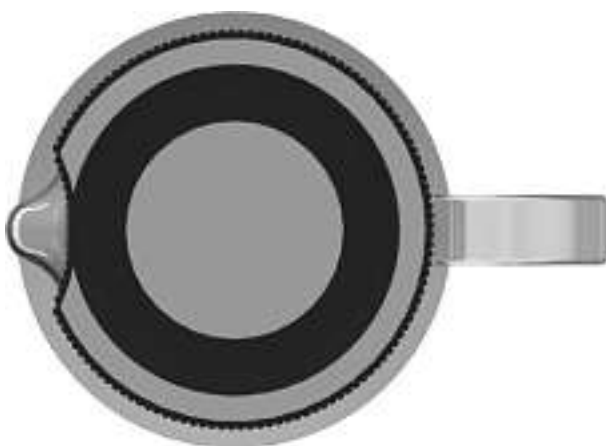

M13427-1

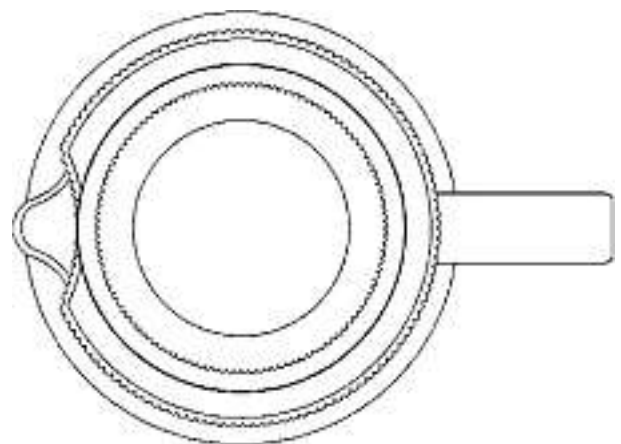
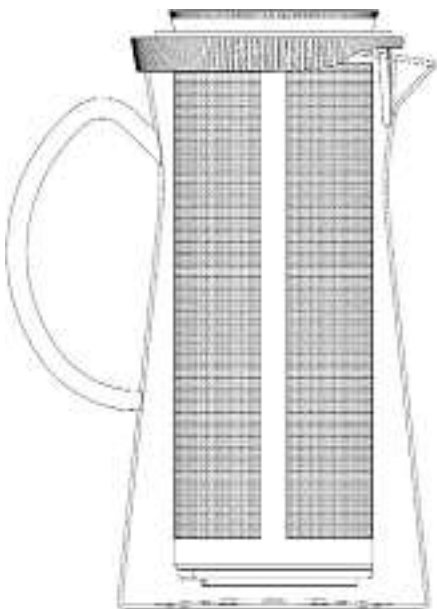
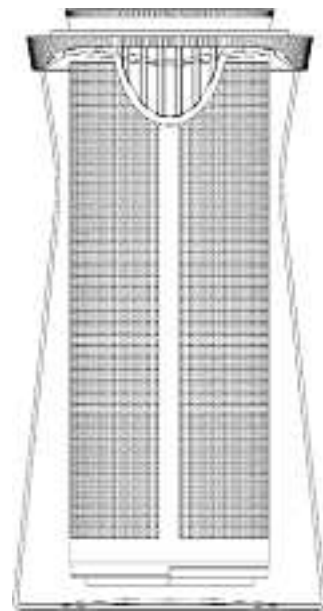
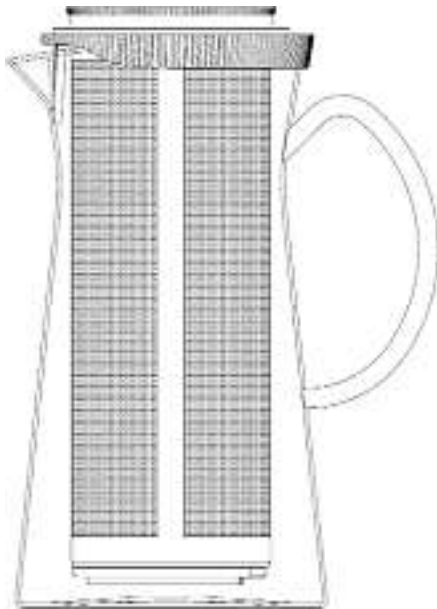
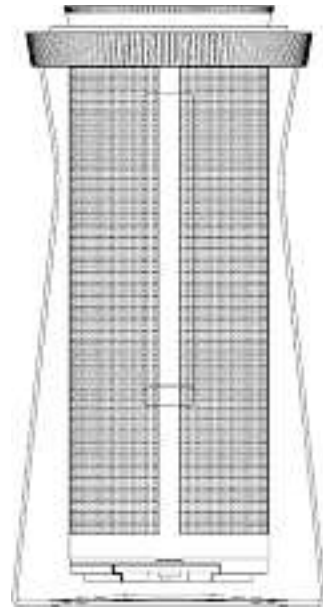
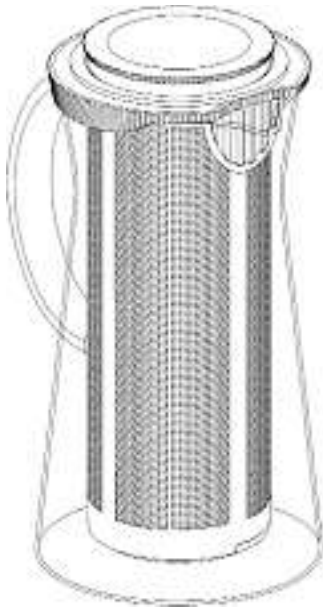

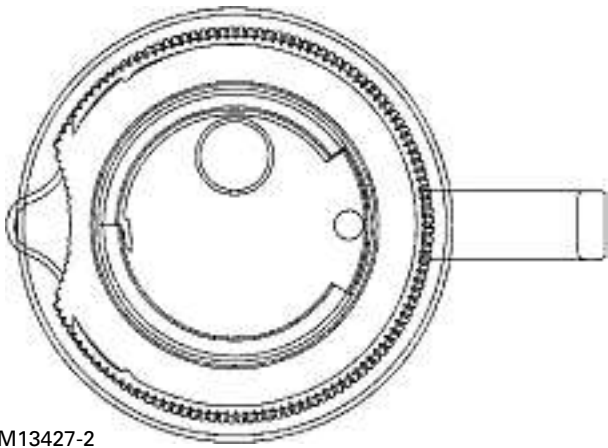

M13427-2

Cl. 07-01 134 488 02.11.2007
1 Design – Trinkgefäss
Hinterleger: Pi-Design AG, Kantonsstrasse 100,
6234 Triengen
Designer: Jørgen Bodum, Meggen
Vertreter: Isler & Pedrazzini AG, 8027 Zürich
Priorität: DK, 11.05.2007

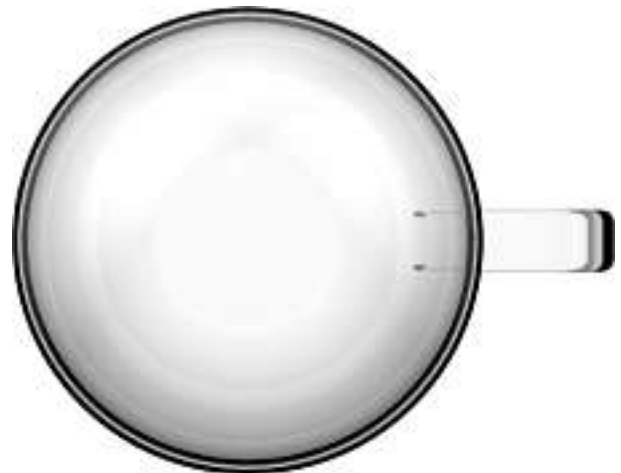



M13426

Cl. 07-02 **134 489** 23.10.2007
 1 Design – Kaffeebereiter
 Hinterleger: Pi-Design AG, Kantonsstrasse 100,
 6234 Triengen
 Designer: Jørgen Bodum, Meggen
 Vertreter: Isler & Pedrazzini AG, 8027 Zürich
 Priorität: DK, 14.05.2007





M13420

Cl. 07-02 **134 490** 02.11.2007
8 Design – Getränkebereiter
Hinterleger: Pi-Design AG, Kantonsstrasse 100,
6234 Triengen
Designer: Jørgen Bodum, Meggen
Vertreter: Isler & Pedrazzini AG, 8027 Zürich
Priorität: DK, 23.05.2007



1

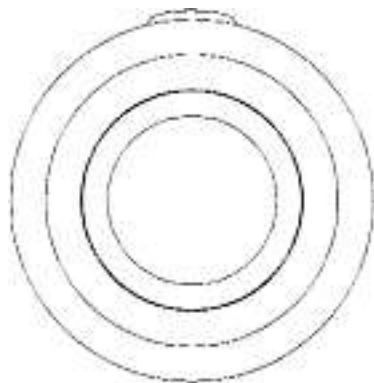

2





3

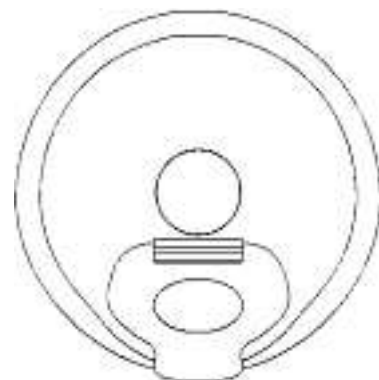

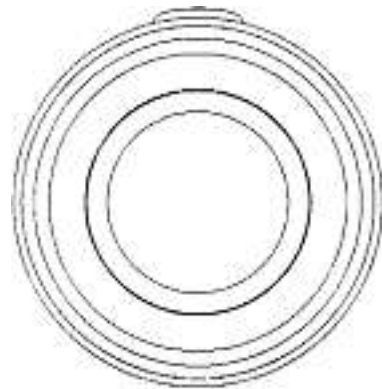
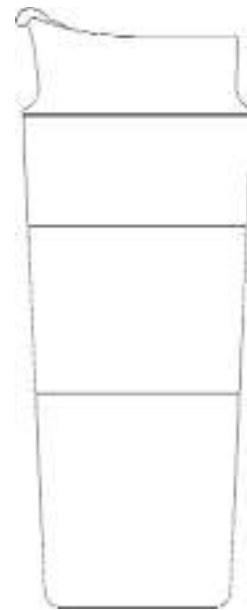
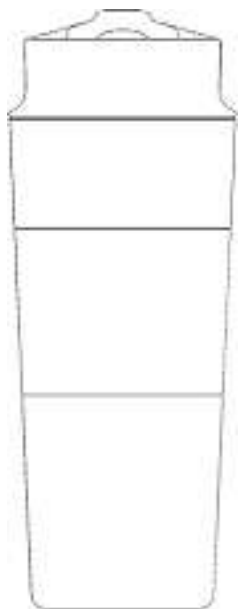
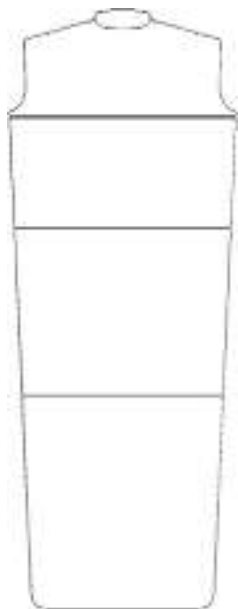

4





5

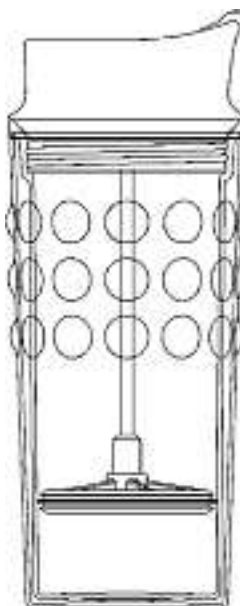

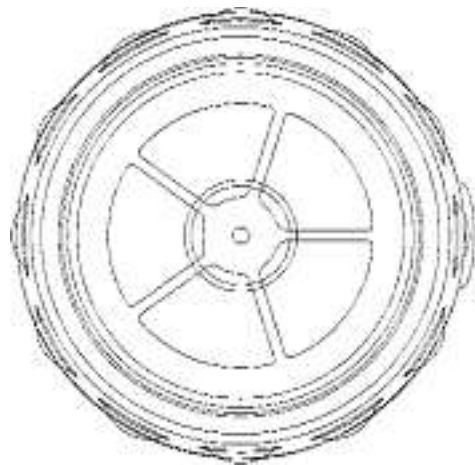
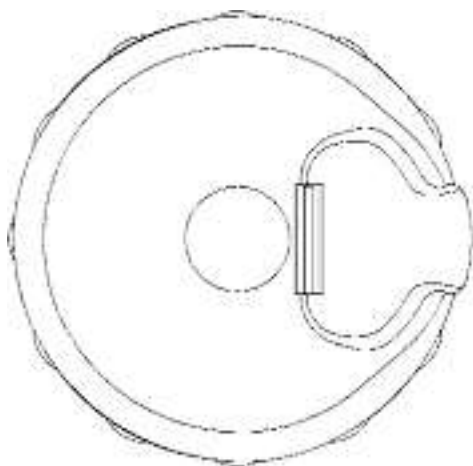
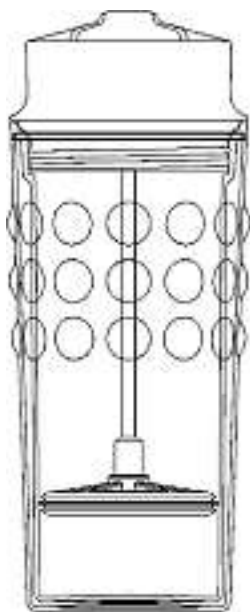
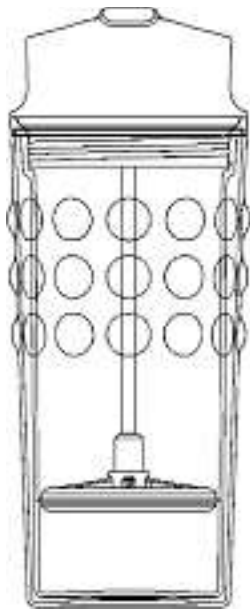

6





7

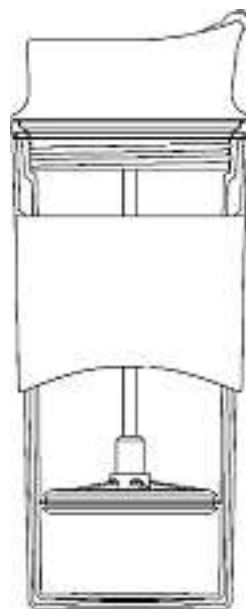
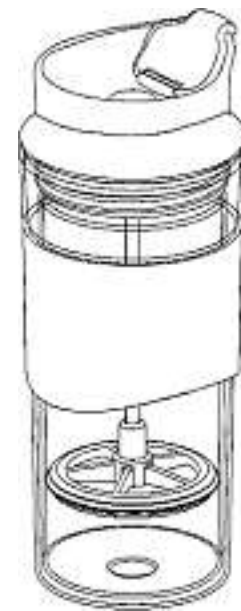

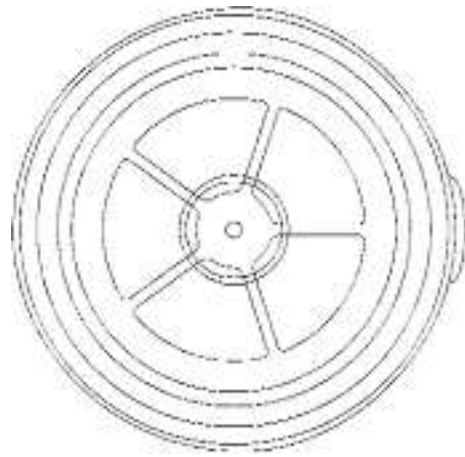
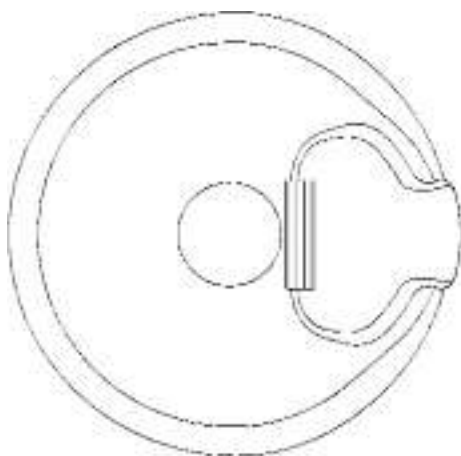
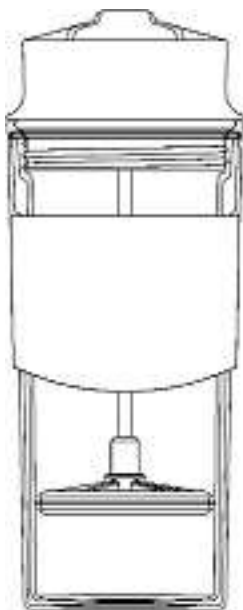
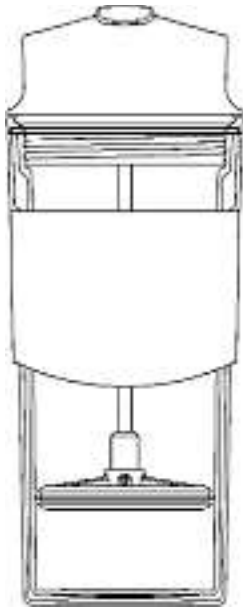

8

Cl. 07-03, 07-06 134 491 30.10.2007
 12 Design – Besteck
 Hinterleger: Migros-Genossenschafts-Bund, Limmatstrasse
 152, 8005 Zürich
 Designer: Mathew Frank, Seattle



1 Sélection Fleischgabel



2 Sélection Gemüsebesteck Gabel





3 Sélection Gemüsebesteck Löffel



4 Sélection Gemüselöffel



5 Sélection Käsehobel



6 Sélection Käsemesser



7 Sélection Reislöffel



8 Sélection Salatbesteck Gabel



9 Sélection Salatbesteck Löffel



10 Sélection Spaghettikelle



11 Sélection Suppenkelle

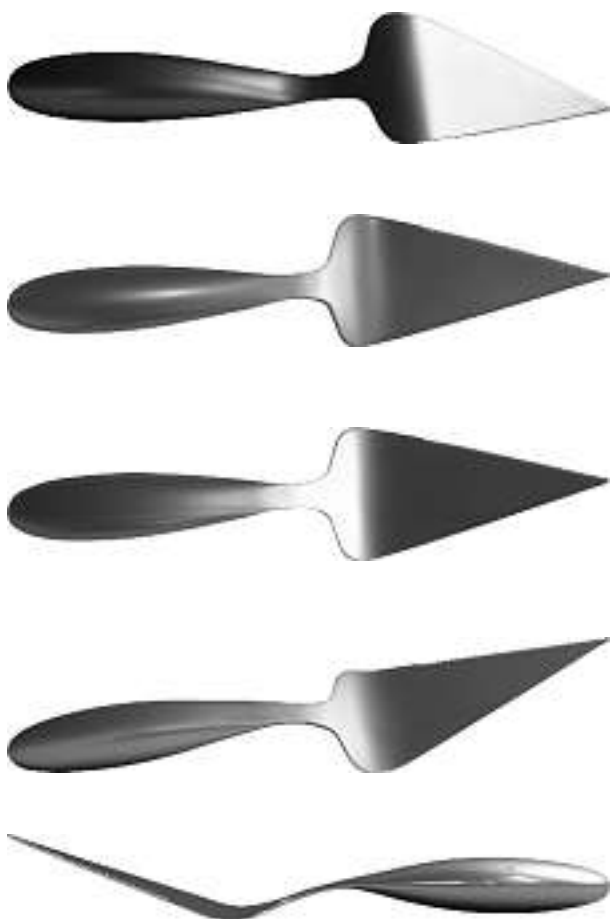

12 Sélection Tortenheber

Cl. 07-08 **134 492** 09.10.2007
 9 design – portes-bûches
 Déposant: L'Art des Choix SA, Rue du Grand-Bureau 19,
 1227 Carouge GE
 Designer: Christian Puaux, Carouge
 Mandataire: Christian Puaux, 1227 Carouge GE



1



2



3



4



7



5



8



6



9

Cl. 08-02 **134 493** 06.11.2007
 1 Design – Meisselhammer
 Hinterleger: Airtec AG, Industriestrasse 40, 4455 Zunzgen
 Designer: Hans-Rudolf Hauenstein, Zunzgen
 Vertreter: Industrieberatung Maier AG, 4450 Sissach



1

Cl. 09-01 **134 494** 25.10.2007
 1 design – flacon de parfum
 Déposant: Emilio Pucci International BV, Oude Utrechtse-
 weg 22-24, 3743 KN Baarn, NL
 Designer: Helle Damkjaer, Paris
 Mandataire: Junod, Guyet, Muhlstein & Lévy, Avocats,
 1206 Genève
 Priorité: EM, 26.04.2007
 Vivara (siehe Farbteil Heftmitte)

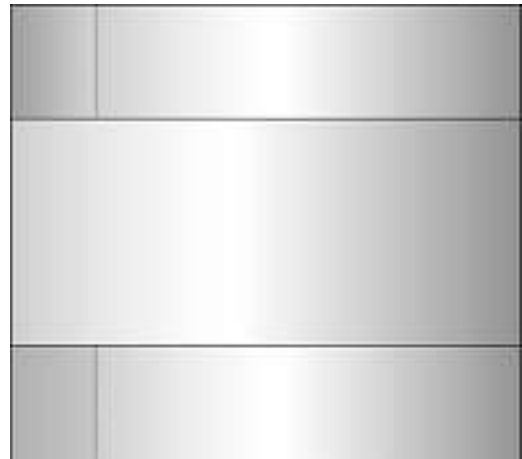

Cl. 09-03 **134 496** 17.10.2007
 1 design – boîte
 Déposant: Guignard desserts Orbe S.A., Grand-Rue 17-19,
 1350 Orbe
 Designer: Caroline Mesple Moser, Lausanne
 Mandataire: MOSER DESIGN SA, 1006 Lausanne



CleverShell



1.1

Cl. 09-03 **134 497** 22.10.2007
 1 Design – Verpackung
 Hinterleger: Imago Werbung GmbH, Gorenmattstrasse 19,
 4102 Binningen
 Designer: Fabienne Bühler, Dornach; Heinz Haudenschild,
 Füllinsdorf

Cl. 09-03 **134 498** 30.10.2007
 3 Design – Verpackung
 Hinterleger: Braun GmbH, Frankfurter Strasse 145,
 61476 Kronberg, DE
 Designer: Lucy Abigail Zimmermann, Kronberg
 Vertreter: Servopatent GmbH, 8702 Zollikon
 Priorität: US, 02.05.2007

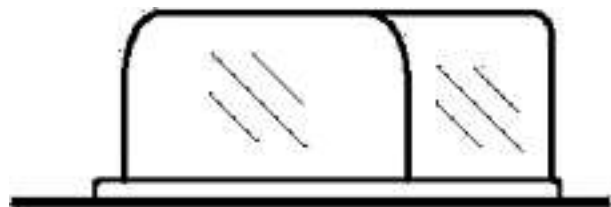

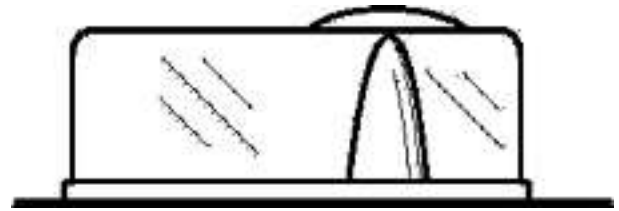
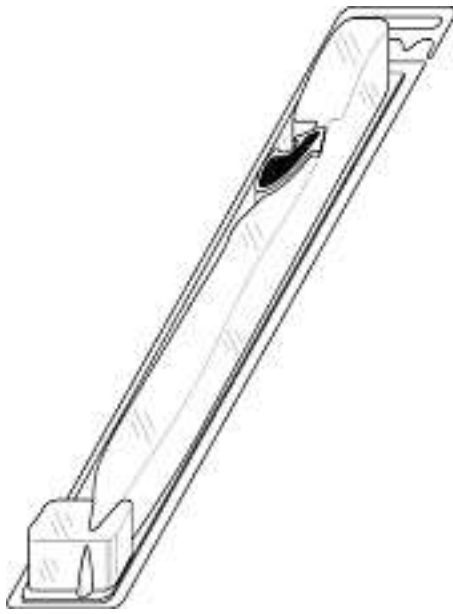

1

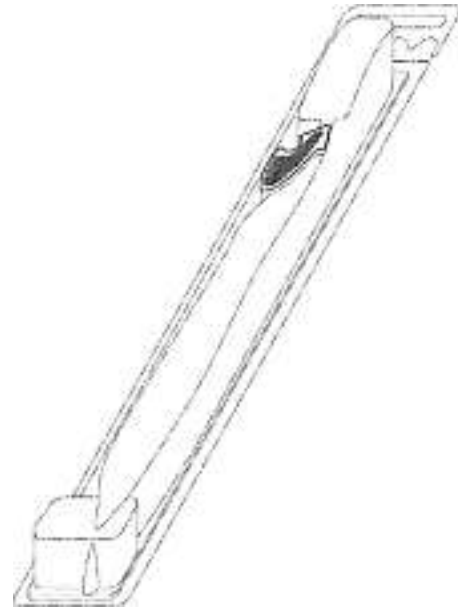

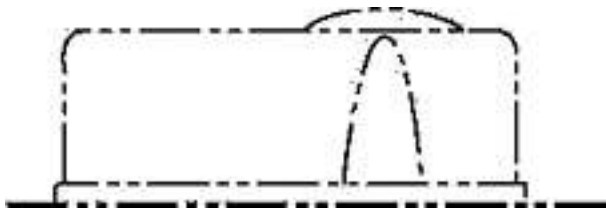

2

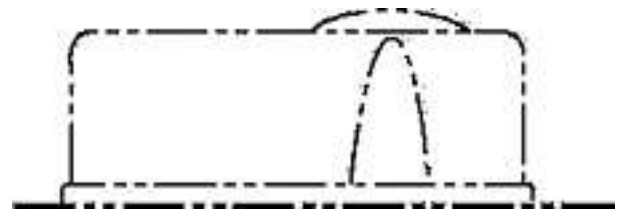

3

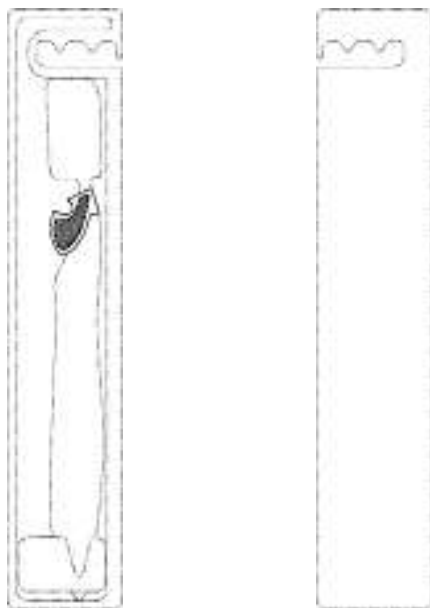
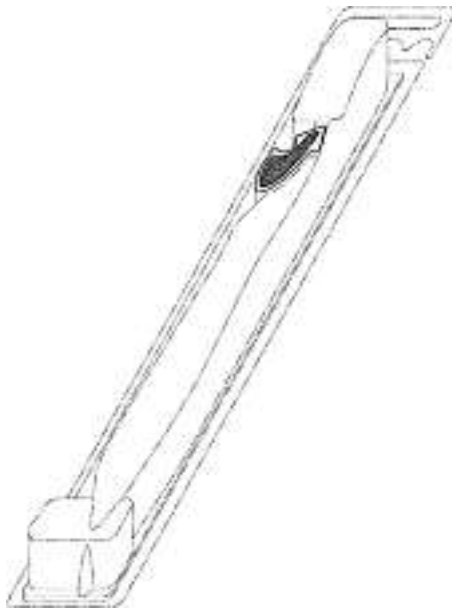

Cl. 09-03 134 499 30.10.2007
 1 Design – Schachtel
 Hinterleger: Glaxo Group Limited, Glaxo Wellcome House,
 Berkeley Avenue, Greenford/Middx, GB
 Designer: Alan John Gilbody, London; Paul N Leung,
 Parsippany; Kerry Louise O'Callaghan, Weybridge
 Vertreter: Isler & Pedrazzini AG, 8027 Zürich
 Priorität: GB, 04.05.2007

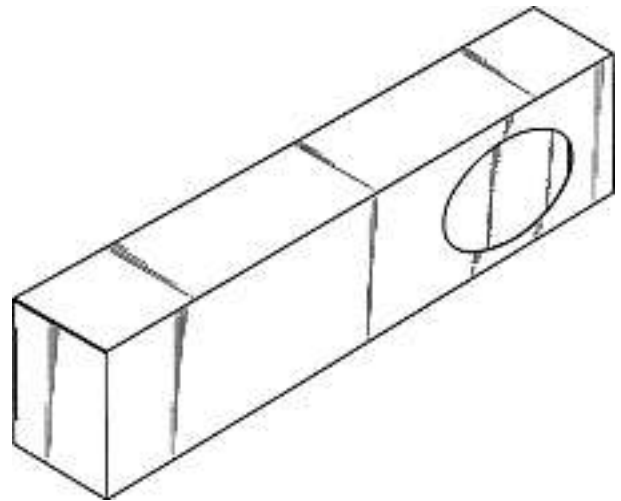

M13425

Cl. 09-03 134 500 02.11.2007
 3 Design – Dosen für Getränke
 Hinterleger: Red Bull GmbH, Am Brunnen 1, 5330 Fuschl
 am See, AT
 Designer: Peter Hüls, Kröv; Roland Concin, Stallehr
 Vertreter: Dr. Renata Kündig, 8008 Zürich
 Priorität: EM, 08.05.2007

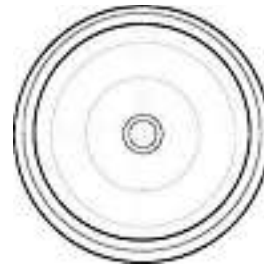

07.M38.CH/DES 0001
 Beschreibung des Designs: Das Design besteht in der abgebildeten Erscheinungsform einer Getränkedose, die sich aus der Verwendung von durchsichtigem Kunststoff, insbesondere PET, für den Dosenmantel und den Dosenboden ergibt.



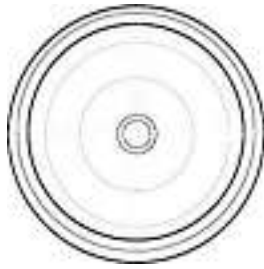

07.M38.CH/DES 0002

Beschreibung des Designs: Das Design besteht in der abgebildeten Erscheinungsform einer Getränkedose, die sich aus der Verwendung von Kunststoff, insbesondere PET, für den Dosenmantel und den Dosenboden ergibt, wobei der Kunststoff undurchsichtig ist oder einen Überzug oder eine Beschichtung trägt.

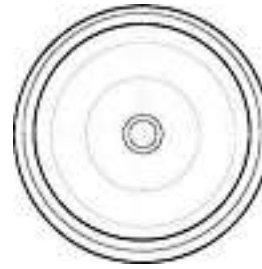

07.M38.CH/DES 0003

Beschreibung des Designs: Das Design besteht in der abgebildeten Erscheinungsform einer Getränkedose, die sich aus der Verwendung von durchsichtigem Kunststoff, insbesondere PET, für den Dosenmantel und den Dosenboden ergibt, wobei auf den Dosenmantel ein Überzug oder eine Beschichtung aufgebracht ist.

Cl. 10-02, 10-07 **134 501** 09.10.2007

2 design – montre

Déposant: Bell & Ross B.V., Boerhaavelaan 22,
2713 HX Zoetermeer, NL

Designer: Bruno Belamich, Paris

Mandataire: ANDRE ROLAND S.A., 1001 Lausanne

Priorité: EM, 10.04.2007

0019-030.D.CH-1 (siehe Farbteil Heftmitte)

0019-030.D.CH-2 (siehe Farbteil Heftmitte)

Cl. 10-02 **134 502** 24.10.2007

2 Design – Steller

Hinterleger: Bruno Messerli, Hauptstrasse 106, 4587 Aetingen

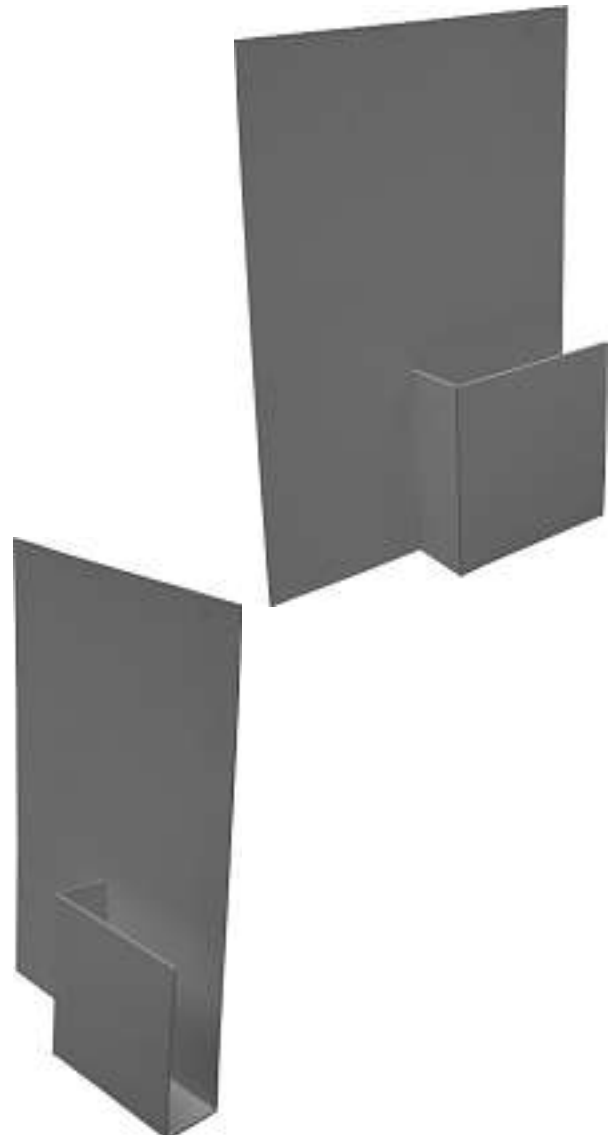



Display Bild

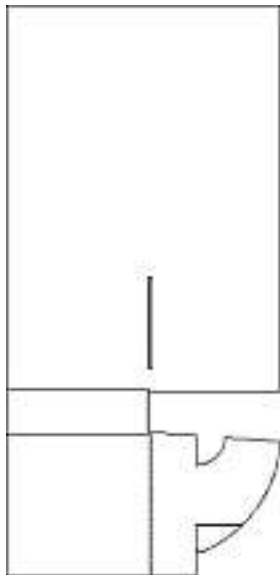

Display Riss

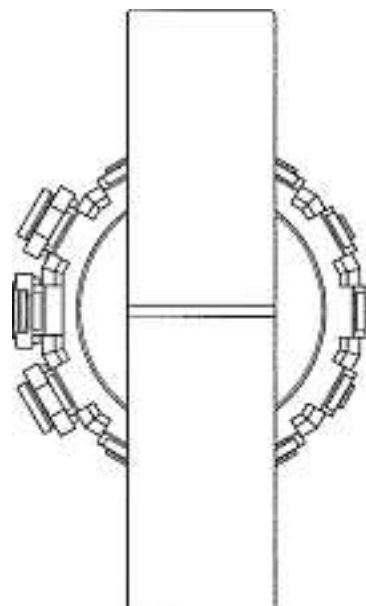
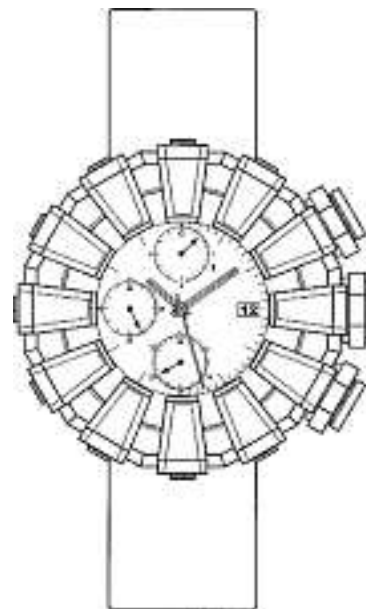
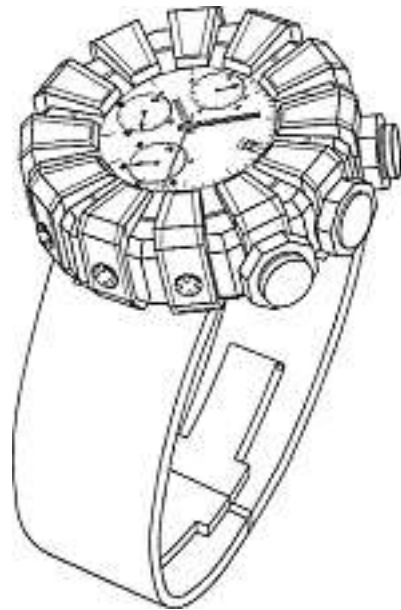

Cl. 10-02 134 503 30.10.2007

1 design – montre

Déposant: Robert Wan Luxury Ltd, Room 2410 24/F China

Resources Building, 26, Harbour Road, Wanchai, HK

Designer: Daryoush Shafa, Rueil Malmaison

Mandataire: Bovard AG, 3000 Bern 25

Priorité: EM, 07.05.2007

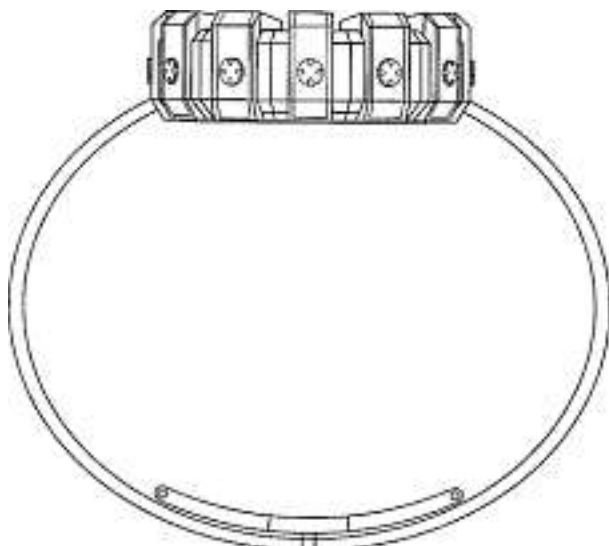

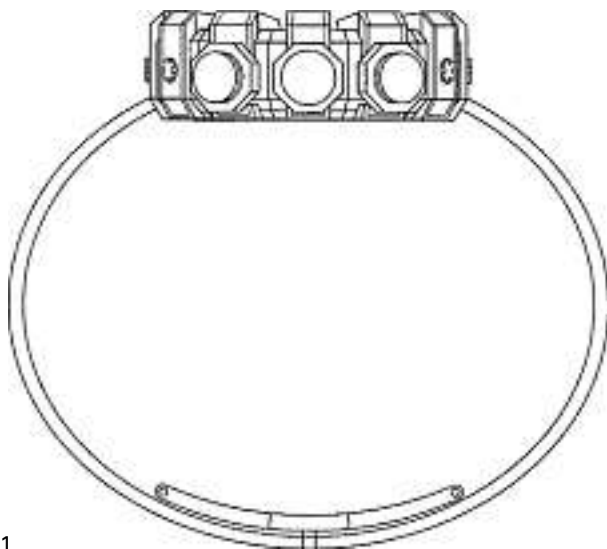
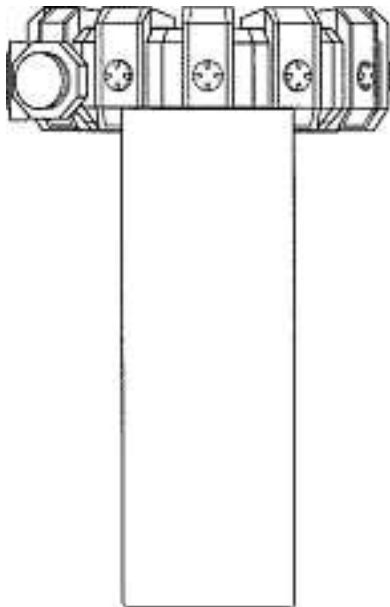
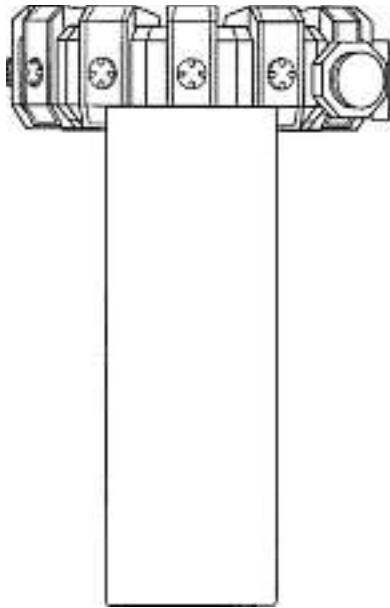

1

Cl. 10-02 134 504 16.11.2007
 11 Design – Armbanduhren
 Hinterleger: Justex Watch GmbH, Am Limmatplatz 1,
 8005 Zürich
 Designer: Christian Celik, Affoltern a.A.



1



2



3



4



7



5



8



6



9



10



11

Cl. 10-07 134 505 22.10.2007
 3 Design – Zifferblätter
 Hinterleger: Prescher Holding GmbH, Weidenweg 8,
 Postfach, 2563 Ipsach
 Designer: Thomas Prescher, Ipsach



01



02



03

Cl. 10-07 134 506 23.10.2007
 3 Design – Uhrengehäuse
 Hinterleger: Siroswiss GmbH, Im Winkel 12, 4411 Seltisberg
 Designer: Roger Metzger, Zürich; Jürg Widmer, Seltisberg



NQA 100



NRA 100



NHA 100



Cl. 11-01 **134 507** 25.10.2007
 5 Design – Ringe
 Hinterleger: Meister + Co AG, Hauptstrasse 66, 8832 Wollerau
 Designer: Fabian Meister, Altendorf; Silvio Daldini, Kilchberg ZH; Thomas Geiser, Schübelbach; Marcus Siessegger, Wald

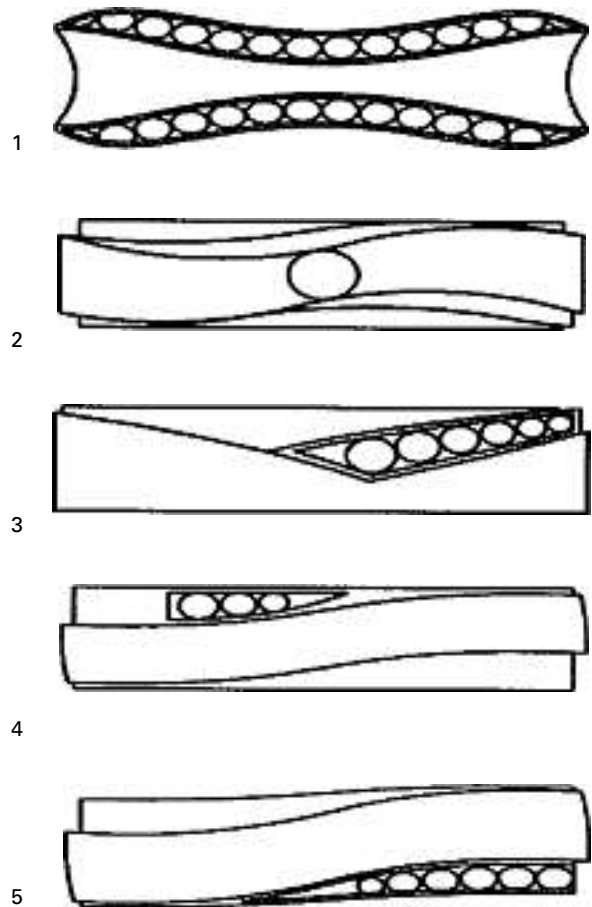

Cl. 14-99 **134 508** 05.11.2007
 2 Design – Gerätehalterungen
 Hinterleger: designtrade gmbh the innovative company,
 Scheyenholzstrasse 55, 3075 Rüfenacht BE
 Designer: Rolf Widmer, Rüfenacht

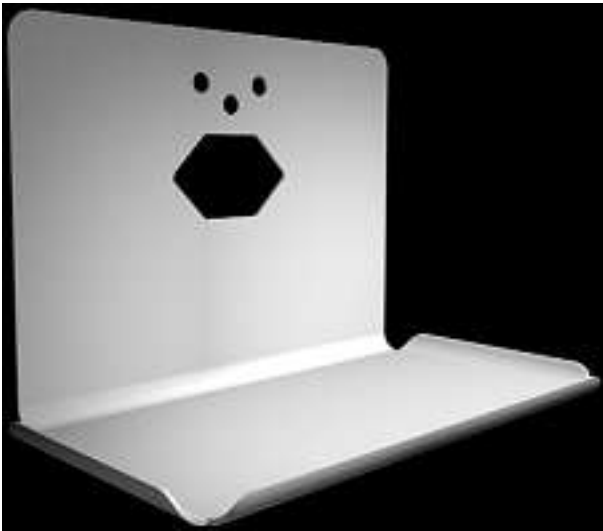

ELP001



ELM001

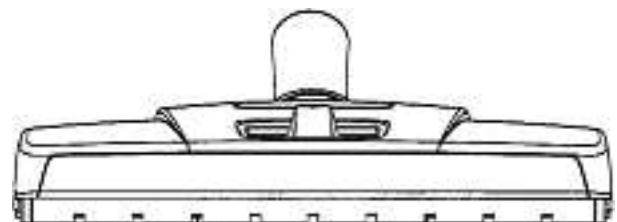
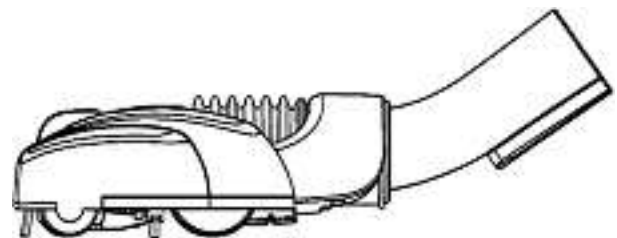
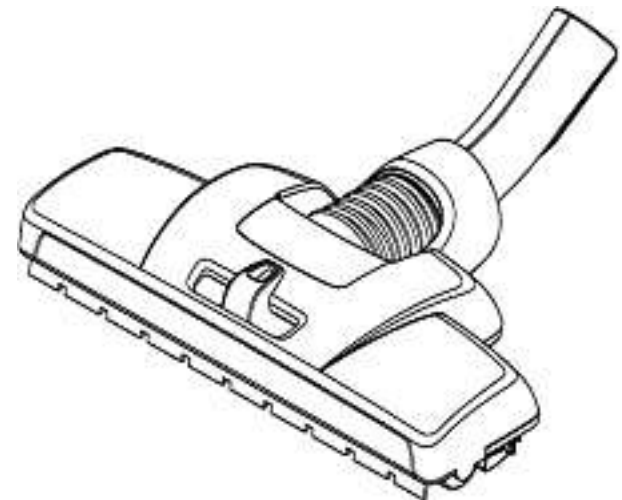
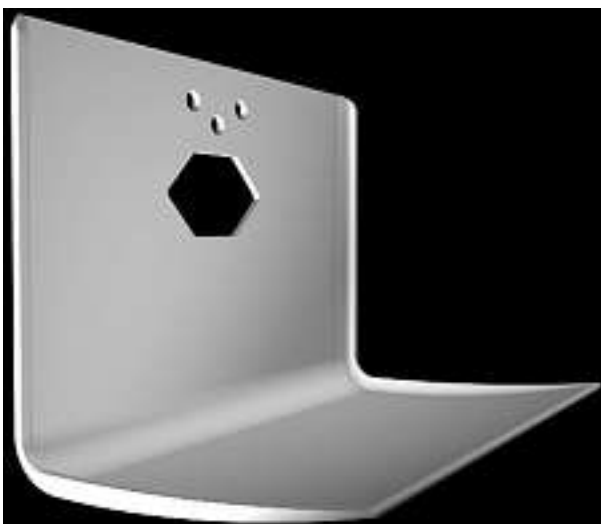

Cl. 15-05 **134 509** 31.10.2007
 1 Design – Staubsaugerdüse
 Hinterleger: Aktiebolaget Electrolux, , Stockholm, SE
 Designer: Anna-Karin Gray, Stockholm
 Vertreter: Troesch Scheidegger Werner AG, Patent- und
 Markenanwälte, 8126 Zumikon
 Priorität: SE, 11.06.2007

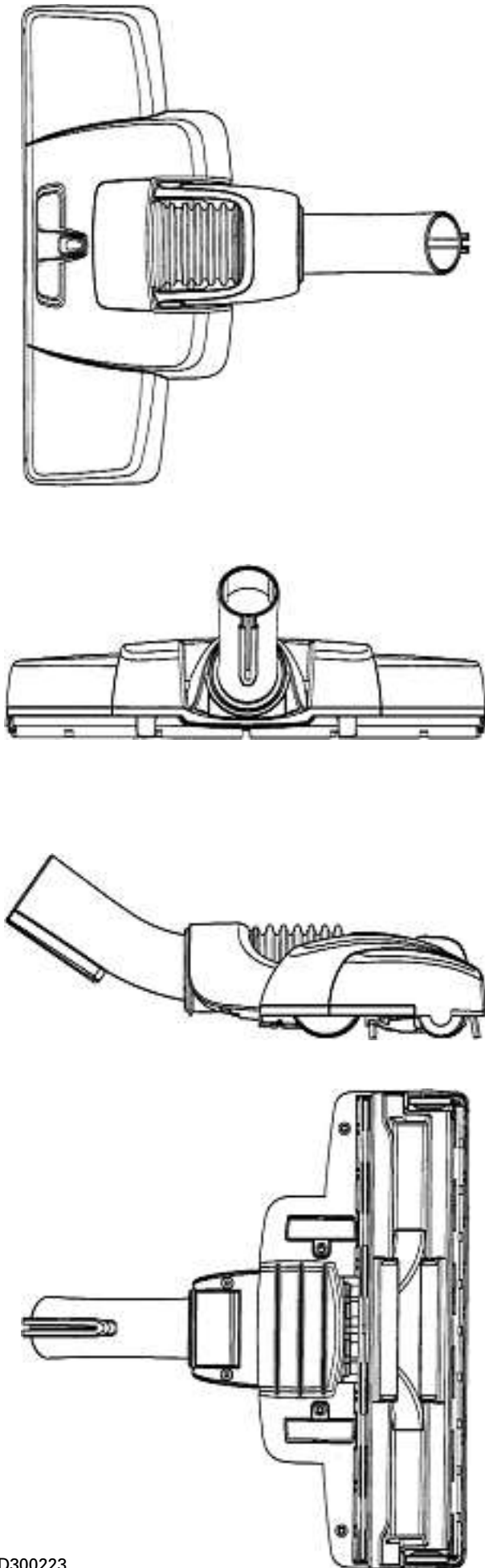

Cl. 15-99 **134 511** 01.11.2007
3 design – machine pour sécher les déchets alimentaires
Déposant: Hee Ja Lee, 110, Hyundai Villa, 61-2, Samseong-
dong, Gangnam-gu, Seoul 135-870, KR
Mandataire: Bovard AG, 3000 Bern 25
Priorité: KR, 09.05.2007; KR, 09.05.2007; KR, 09.05.2007

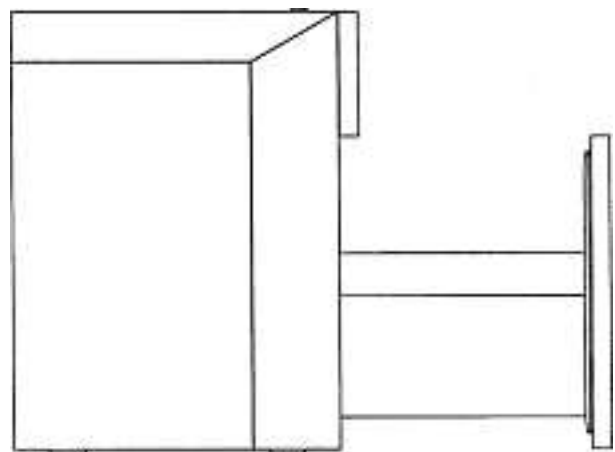
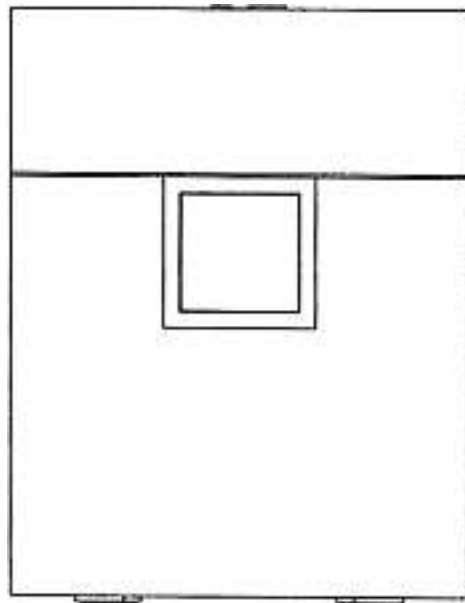
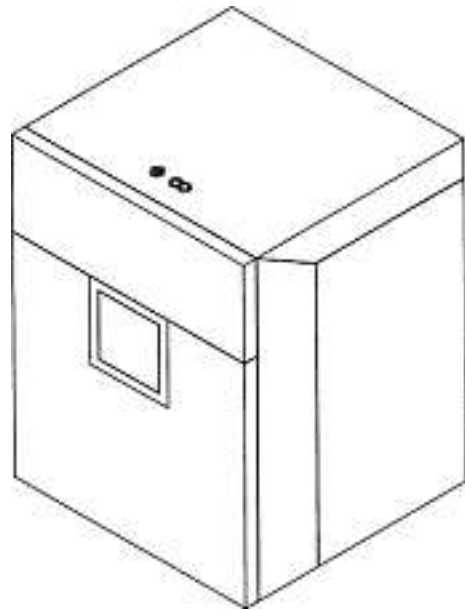

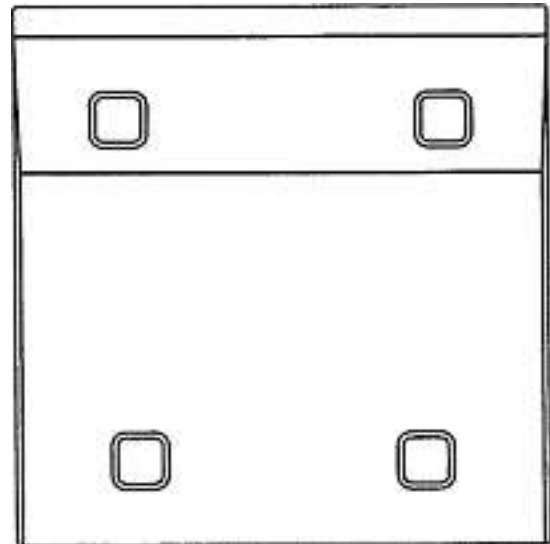
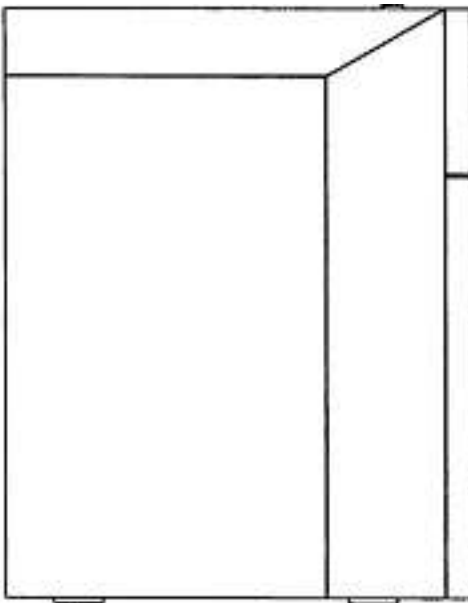
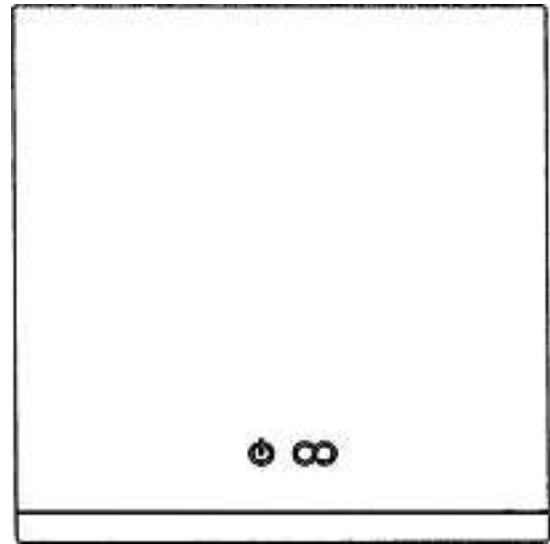
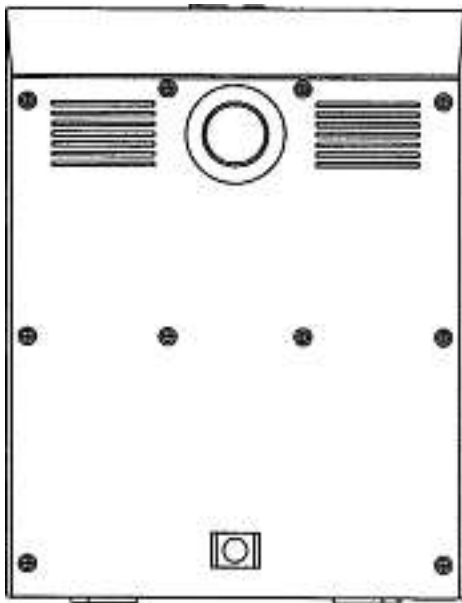

1

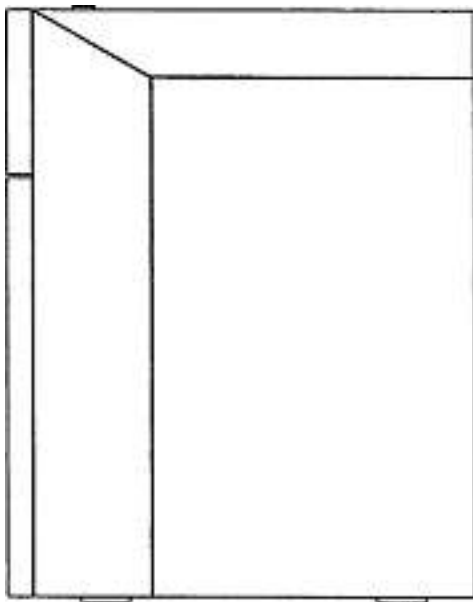

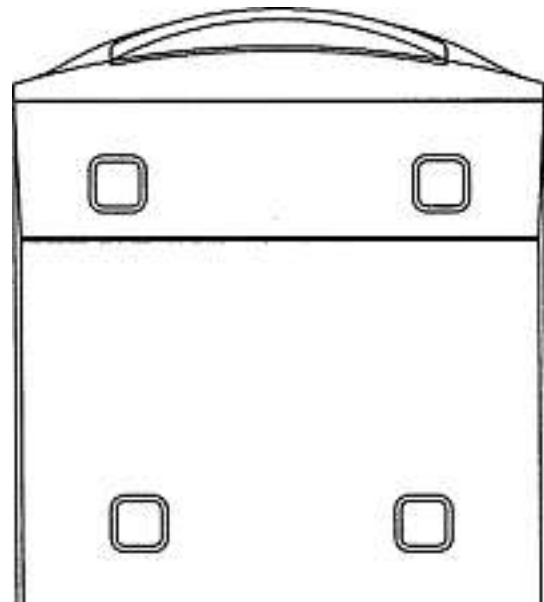
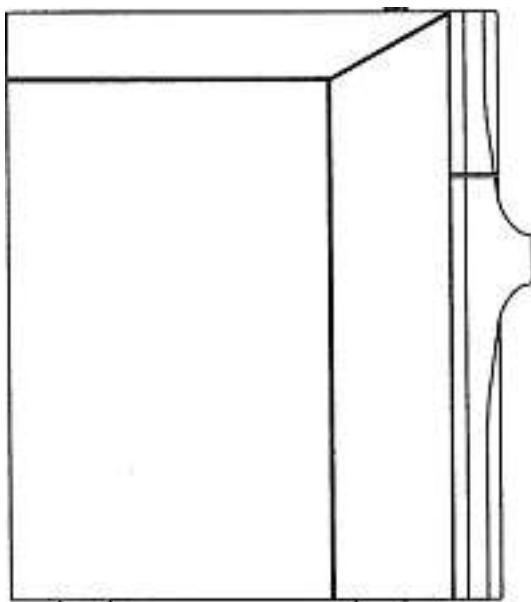
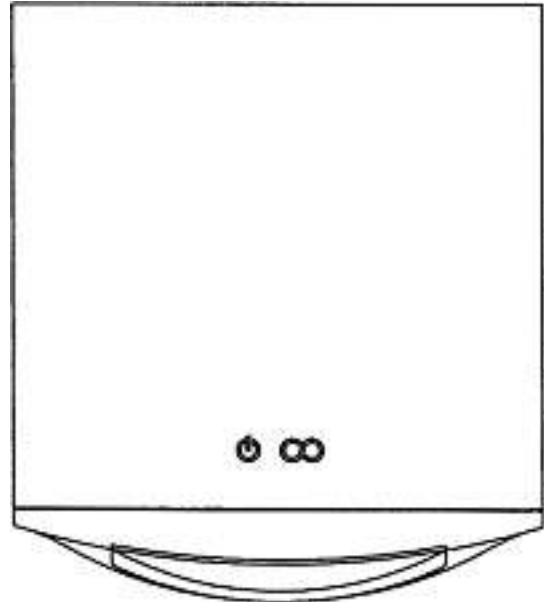
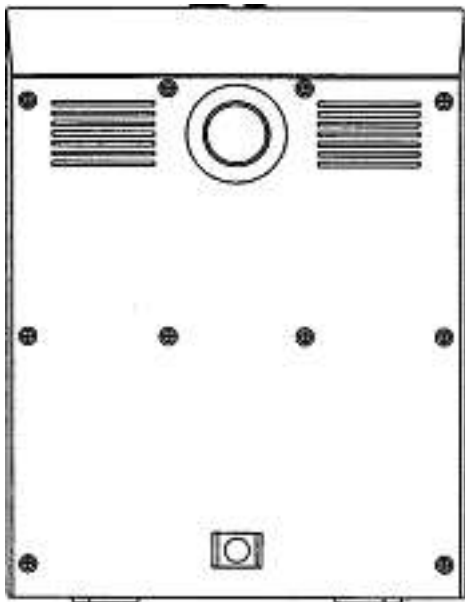
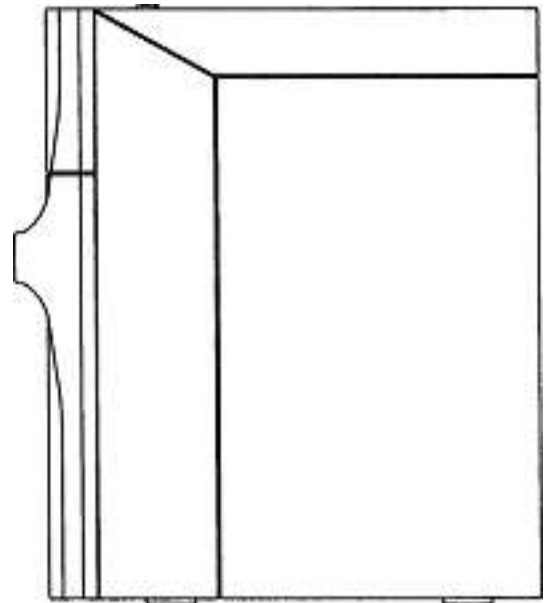
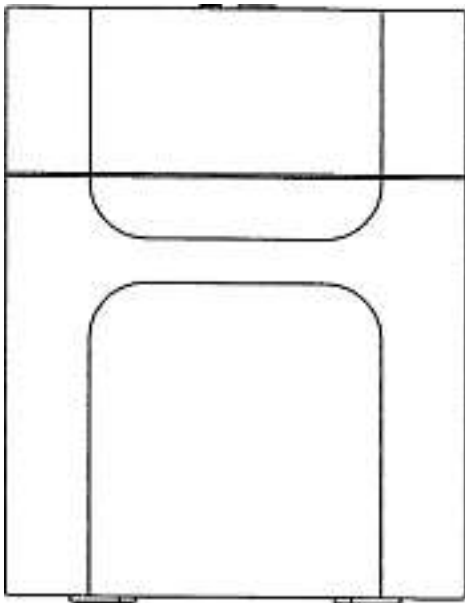

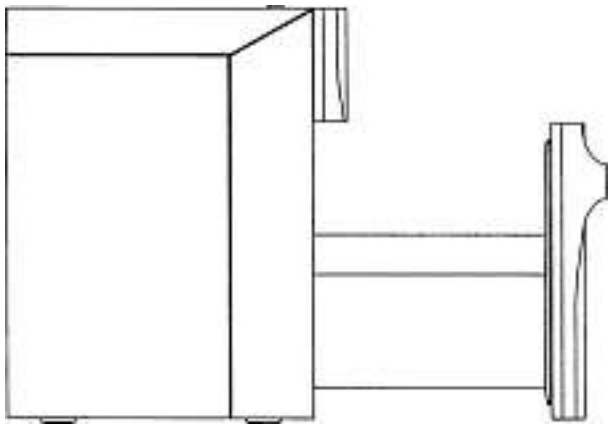

2

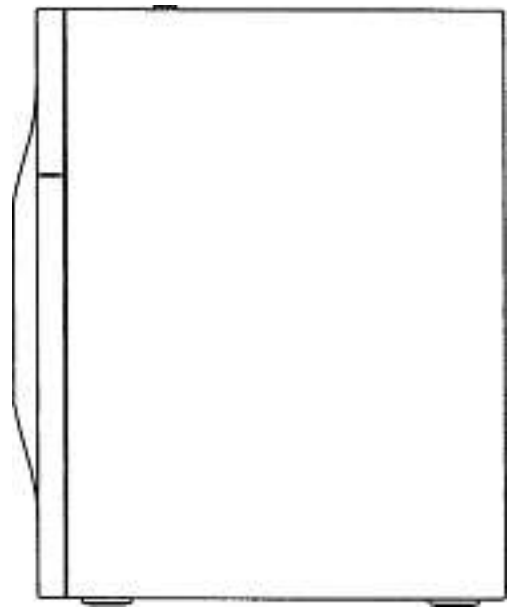
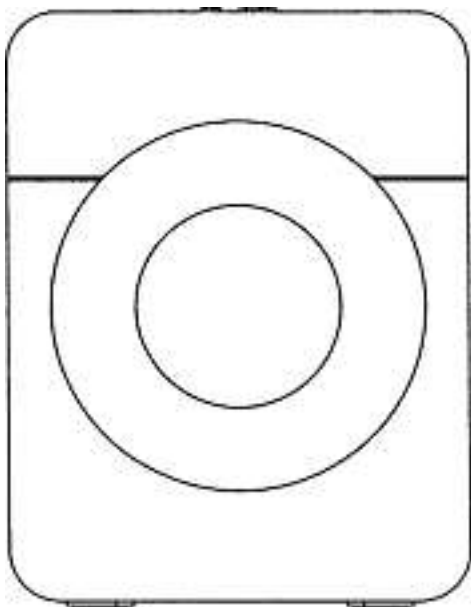
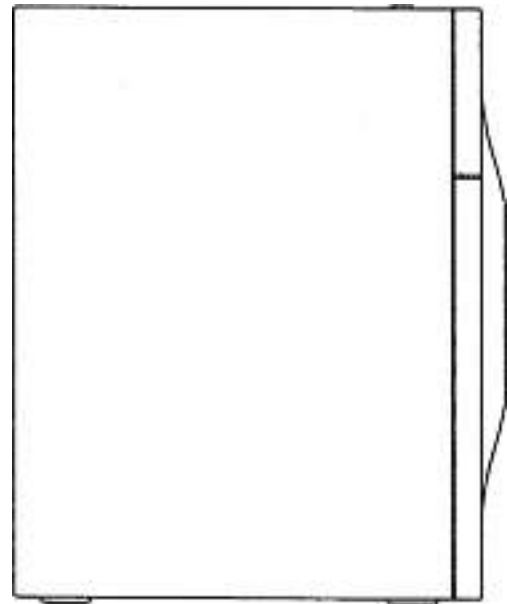
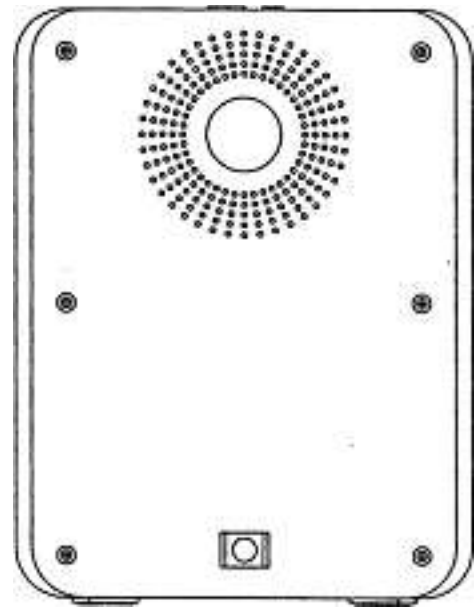

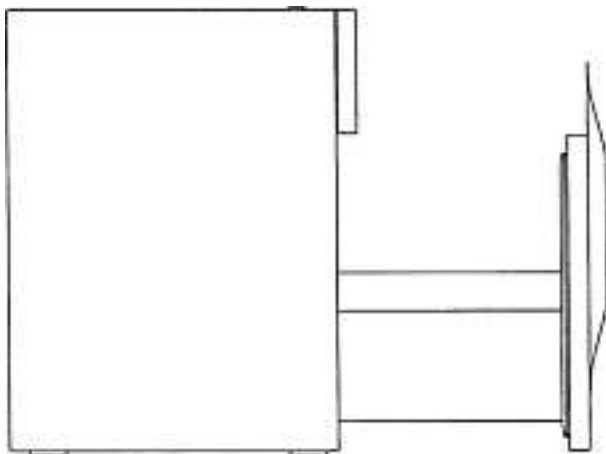
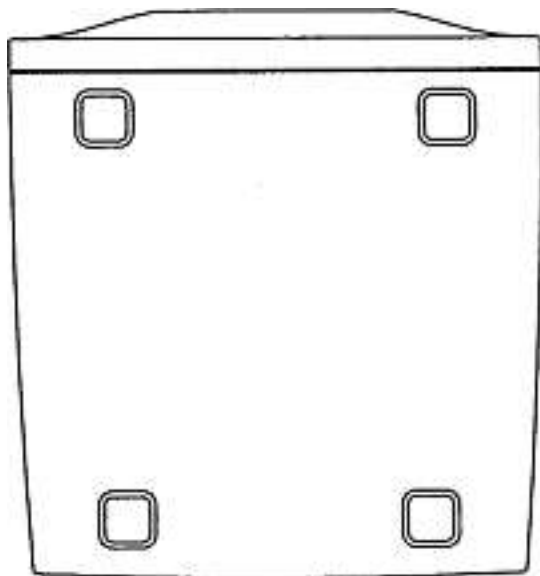
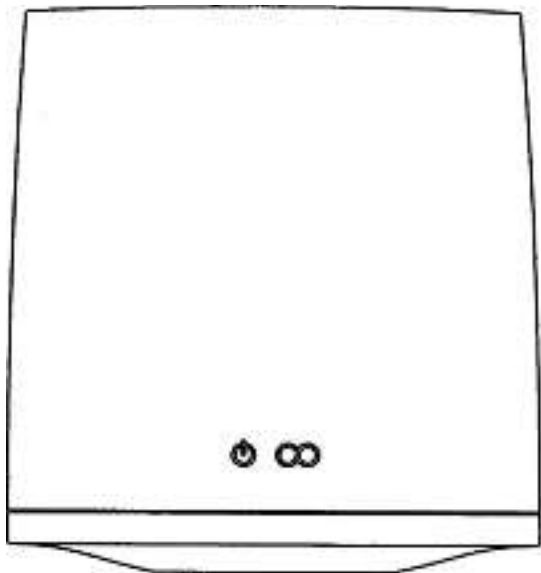

3



Cl. 17-05 **134 512** 26.10.2007
 2 Design – Spieldosen
 Hinterleger: ASW Schwarzer GmbH, Untere Donners-
 bergstrasse 52, 52222 Stolberg, DE
 Designer: Werner Schwarzer, Stolberg
 Vertreter: Pestalozzi Lachenal Patry, 8001 Zürich
 Priorität: EM, 05.07.2007



fled34/1



fled34/2

Cl. 19-02 134 513 01.11.2007
 1 Design – Korrekturbandhalter
 Hinterleger: Pentel Kabushiki Kaisha, No. 7-2, Nihonbashi,
 Koami-cho, Chuo-ku/Tokyo, JP
 Designer: Kazuhisa Shimizu, Tokyo
 Vertreter: Bovard AG, 3000 Bern 25
 Priorität: JP, 09.05.2007

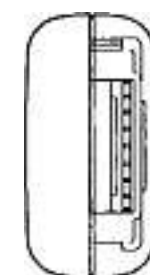
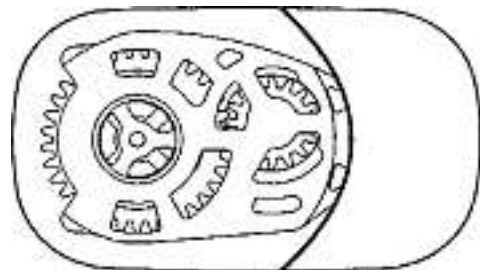
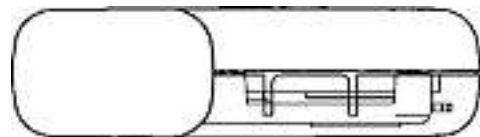
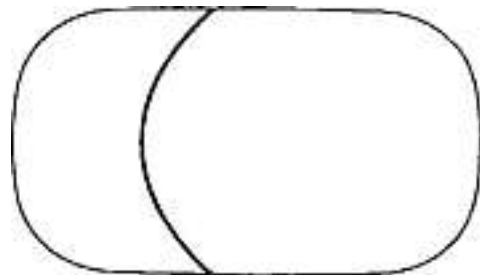
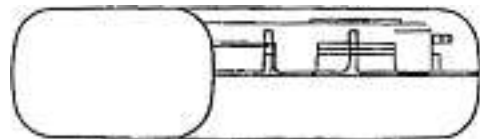
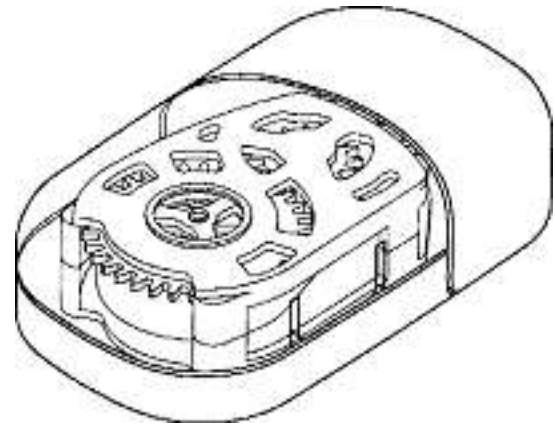

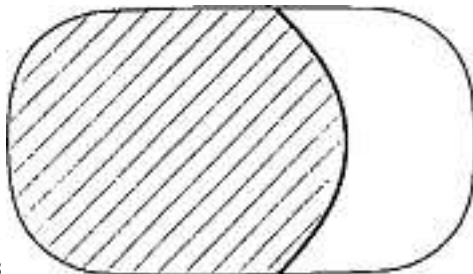
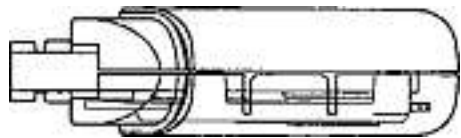
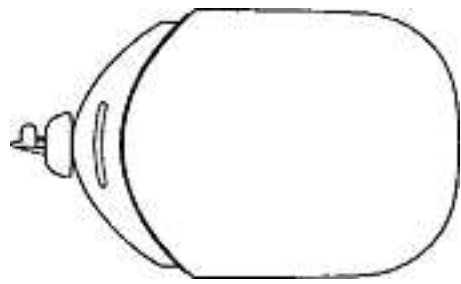

300628

Cl. 19-04 134 514 19.10.2007
1 Design – Notizbuch
Hinterleger: Prodir S.A., 6814 Cadempino
Designer: Christoph Schnug, Milano
Vertreter: Baker & McKenzie, 8034 Zürich

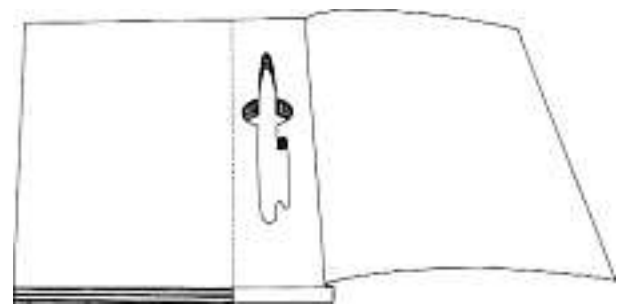
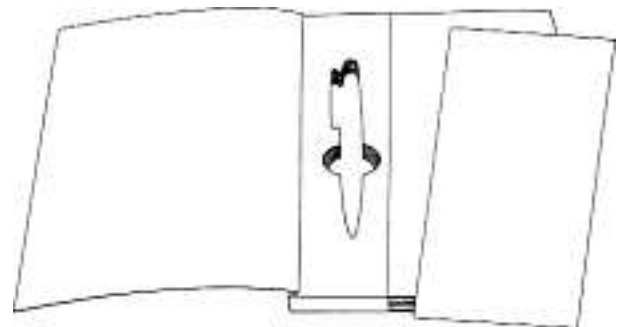
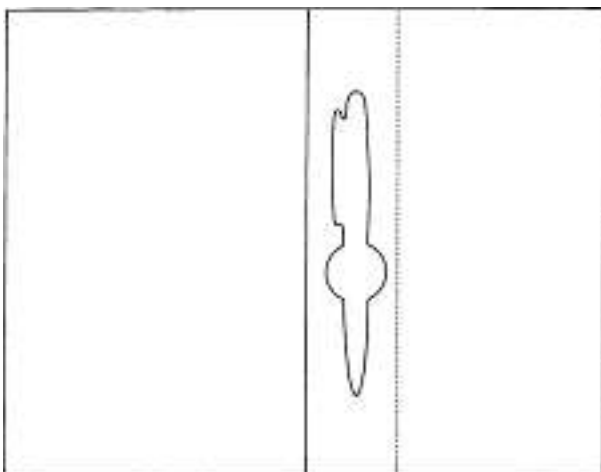



CS8

Cl. 19-06 134 515 08.10.2007

1 design – stylo pilulier

Déposant: Hip Shing Fat Co Ltd, 1829-1832, 18th Floor Star House, 3, Salisbury Road, Tsimshatsui, Kowloon, HK

Designer: Peter Lee, Kowloon

Mandataire: Cabinet Roland Nithardt, Conseils en Propriété Industrielle SA, 1400 Yverdon-les-Bains

Priorité: GB, 25.04.2007

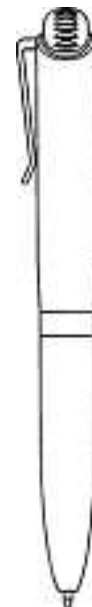
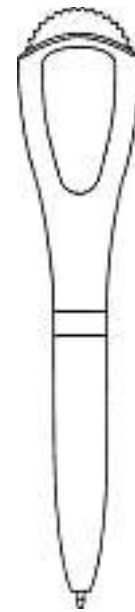
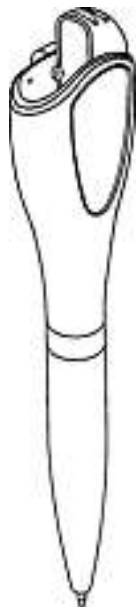
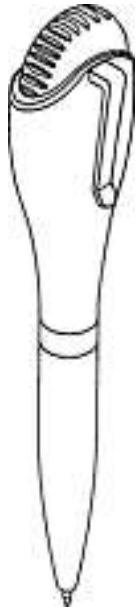

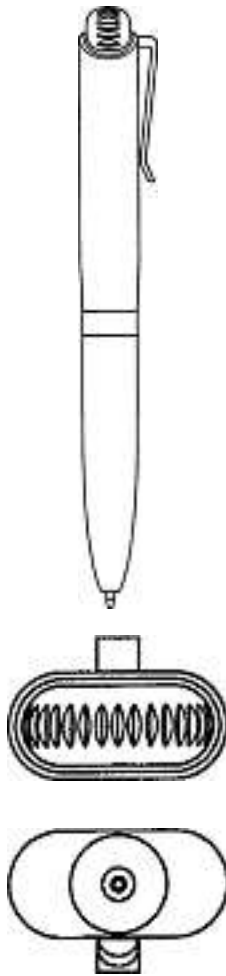

11092

Cl. 19-06 **134 516** 24.10.2007
 4 design – instrument d'écriture et son capuchon
 Déposant: Caran d'Ache SA, 19, chemin du Foron,
 1226 Thônex
 Designer: Astrid Alberto-Wikbert, Genève
 Mandataire: MICHELI & CIE SA, 1226 Thônex

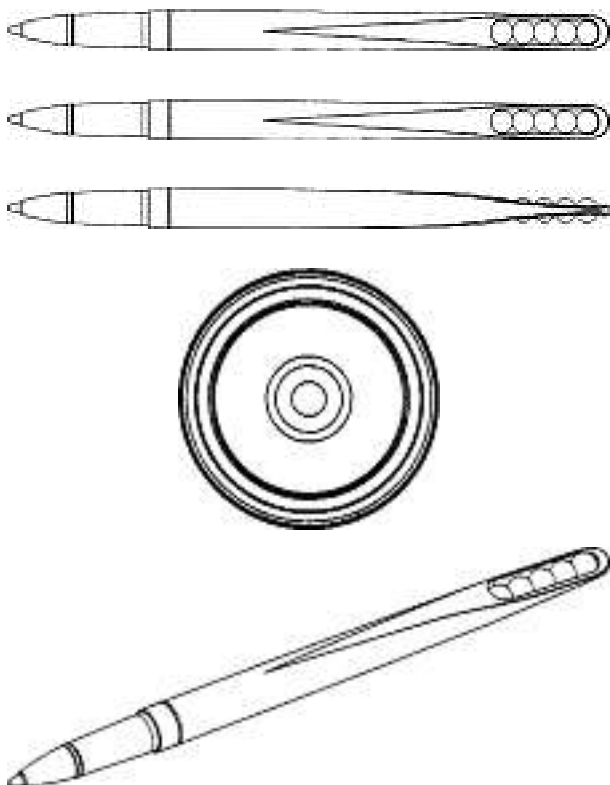

1470

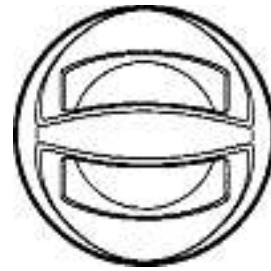

15094A

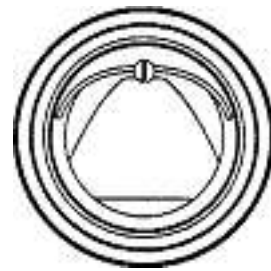
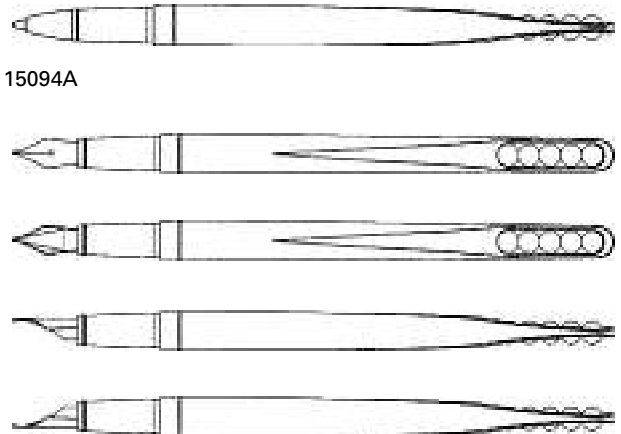

15094B

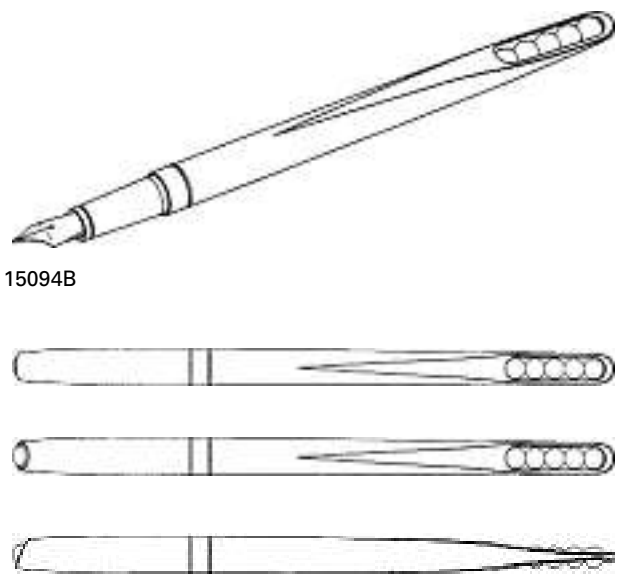

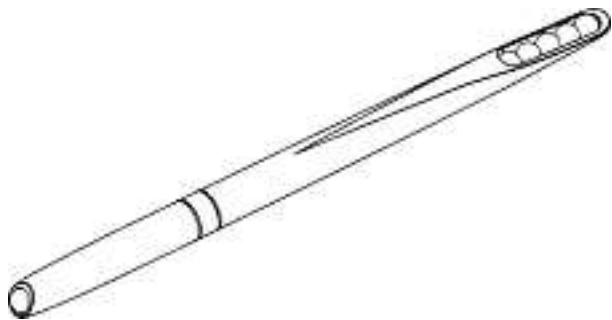
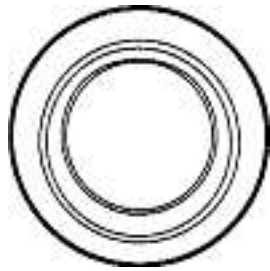

15094C

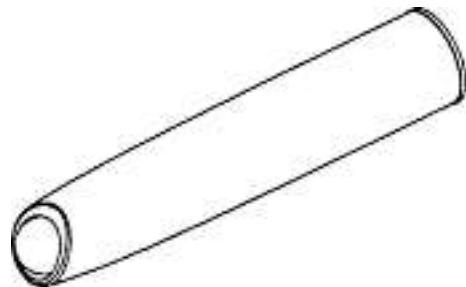
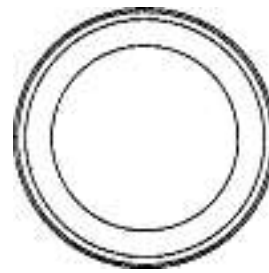
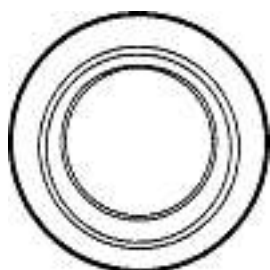

15094D

Cl. 19-06 134 517 12.11.2007
 1 Design – Schreibgerät
 Hinterleger: Prodir S.A., 6814 Cadempino
 Designer: Christoph Schnug, Milano
 Vertreter: Baker & McKenzie, 8034 Zürich





Cl. 19-08 **134 519** 03.12.2007
 8 design – imprimés
 Déposant: Société des Produits Nestlé SA, 1800 Vevey
 Designer: Virginie Beyer, Trois Epis
 Mandataire: Nestec S.A., 1800 Vevey
 1 (siehe Farbteil Heftmitte)
 2 (siehe Farbteil Heftmitte)
 3 (siehe Farbteil Heftmitte)
 4 (siehe Farbteil Heftmitte)
 5 (siehe Farbteil Heftmitte)
 6 (siehe Farbteil Heftmitte)
 7 (siehe Farbteil Heftmitte)
 8 (siehe Farbteil Heftmitte)

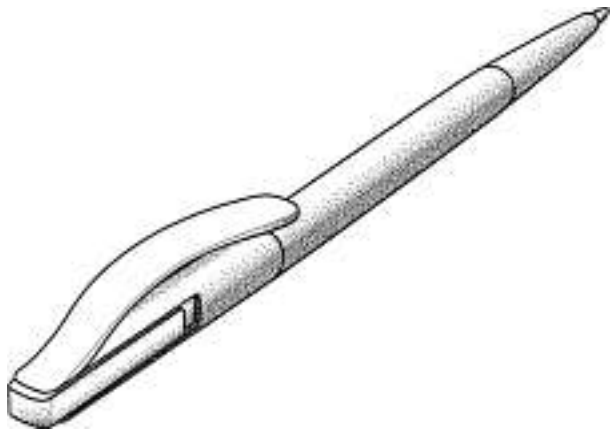

Cl. 20-03 **134 520** 25.10.2007
 4 Design – Türschilder
 Hinterleger: gröflin & partner, Wallstrasse 12, 4051 Basel
 Designer: Daniel Gröflin, Basel



1



2

DS2

Cl. 19-08 **134 518** 08.11.2007
 2 design – imprimés
 Déposant: Société des Produits Nestlé SA, 1800 Vevey
 Designer: Polly Williams, London
 Mandataire: Nestec S.A., 1800 Vevey
 FL 69223/1 (siehe Farbteil Heftmitte)
 FL 69223/2 (siehe Farbteil Heftmitte)

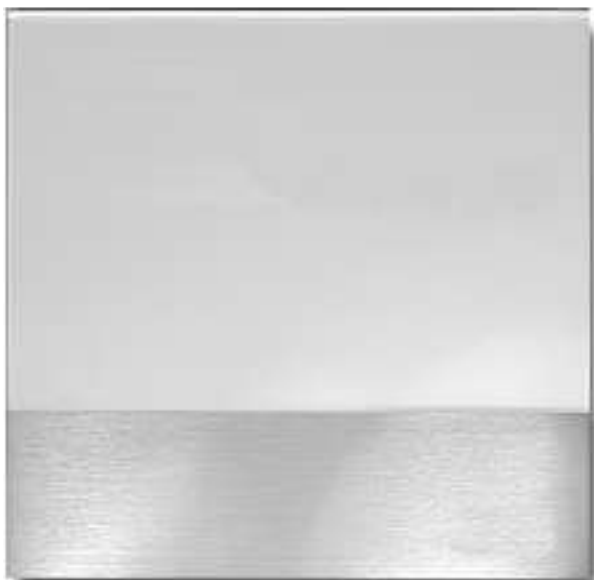

3



4

Cl. 21-02 **134 521** 06.11.2007
 3 Design – Trainingsgerät
 Hinterleger: Rudolf Frei, Am Fischerrain 8, 79199 Kirchzarten, DE
 Vertreter: Hans Rudolf Gachnang, Patentanwalt,
 8501 Frauenfeld
 Priorität: EM, 28.06.2007
 1 (siehe Farbteil Heftmitte)
 2 (siehe Farbteil Heftmitte)
 3 (siehe Farbteil Heftmitte)

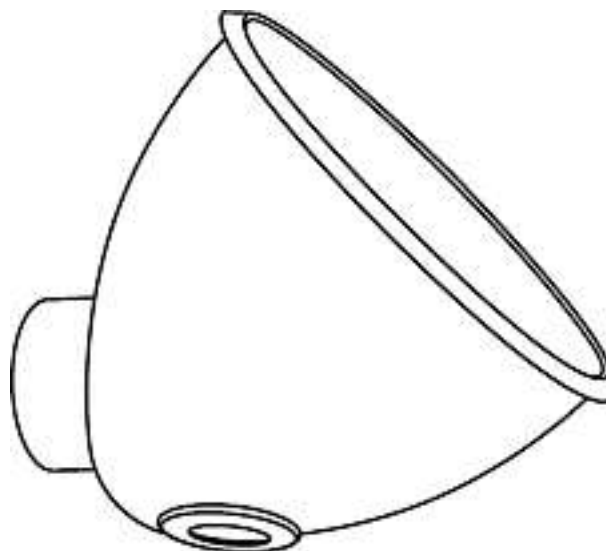
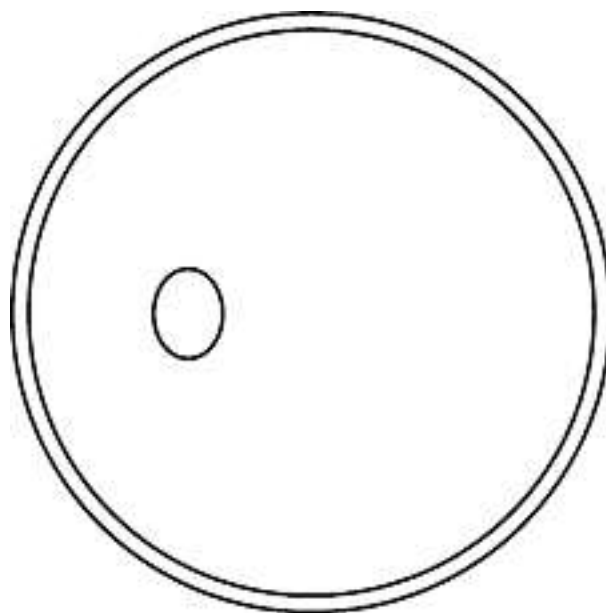

Cl. 23-02 **134 522** 07.11.2007
 1 Design – Urinal
 Hinterleger: Hans Keller, Langrütistrasse 77, 8635 Dürnten
 Vertreter: Gachnang AG Patentanwälte, 8501 Frauenfeld

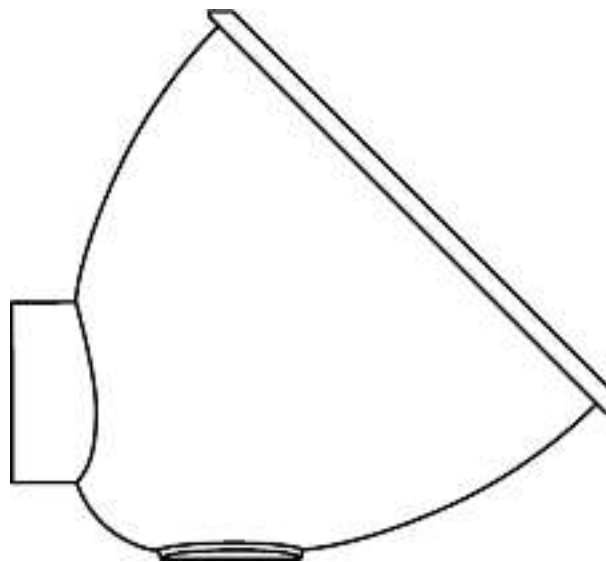
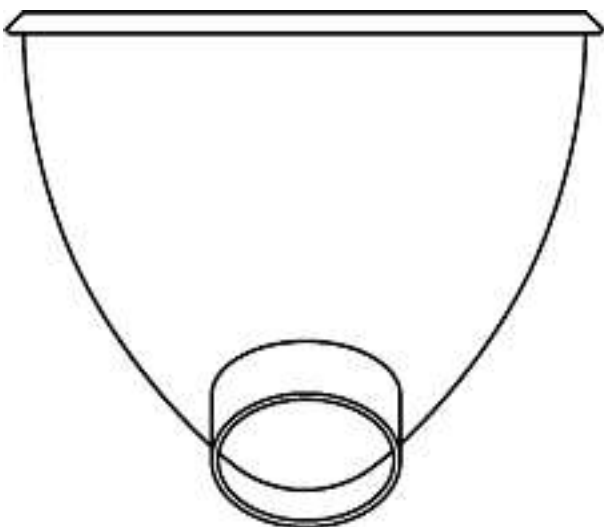

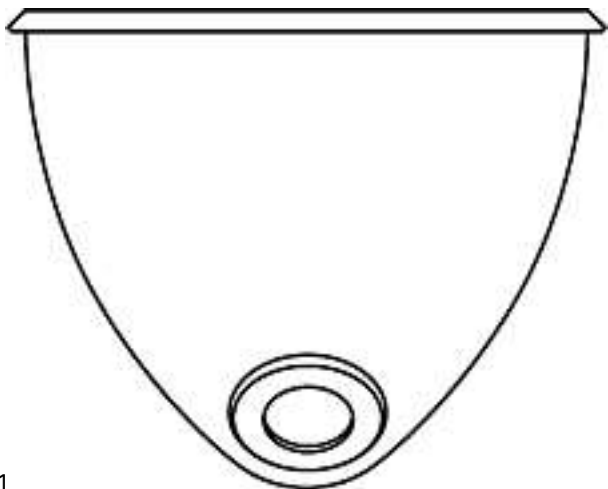
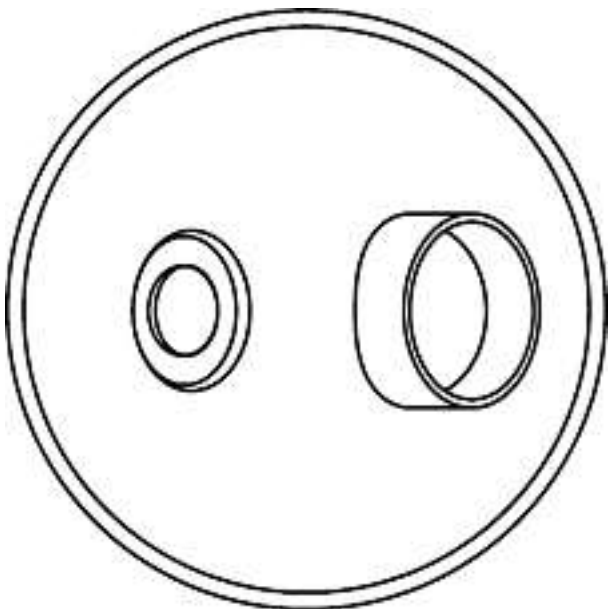
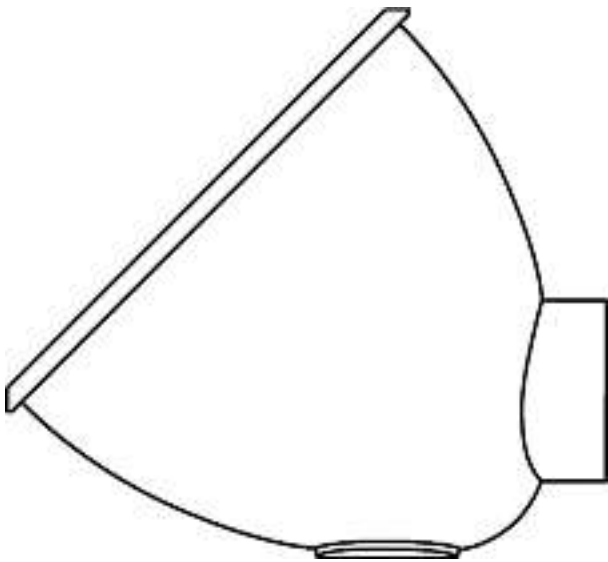

1

Cl. 23-03 **134 523** 10.10.2007
 1 Design – Feuerstelle
 Hinterleger: Eduard von Fellenberg, ch. du Champ-de-Blé 6, 1292 Chambésy

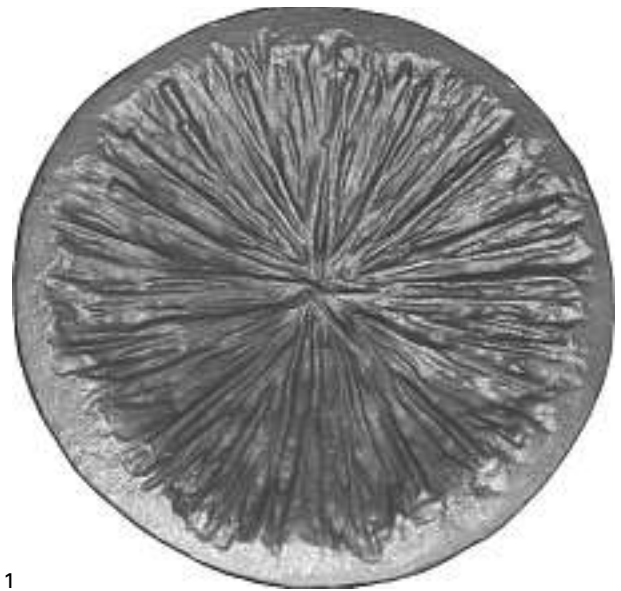

1

Cl. 24-99 **134 524** 12.11.2007
 1 Design – Zahnseidenspender
 Hinterleger: GABA International AG, Emil Frey-Strasse 100, 4142 Münchenstein
 Designer: Martin Schellert, Basel; Olaf Thomas, Münster
 Vertreter: A. Braun, Braun, Héritier, Eschmann AG, Patentanwälte, 4051 Basel
 1 (siehe Farbteil Heftmitte)

Cl. 25-02 **134 525** 09.11.2007
 1 Design – Deckenelement/Bauelement
 Hinterleger: Jan Waldmann, Hegianwandweg 99, 8045 Zürich

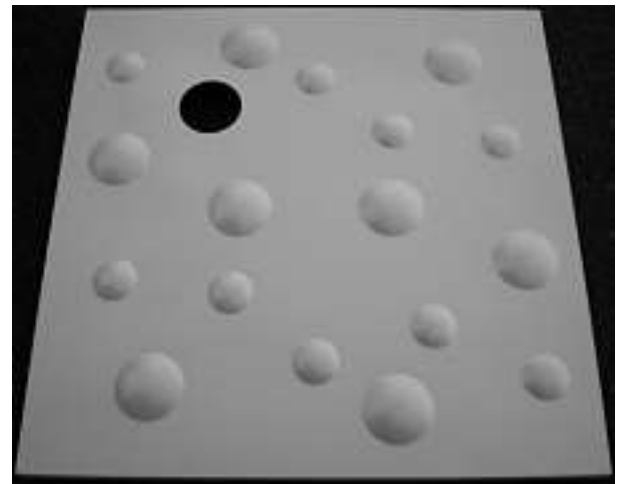

0701

Cl. 25-03 **134 526** 19.10.2007
 2 Design – Schutzunterkunft und Zubehör
 Hinterleger: Hesco Bastion Limited, Unit 37, Knowsthorpe Gate, Cross Green Industrial Estate, Leeds LS9 0NP, GB
 Designer: James Heselden, Leeds
 Vertreter: Isler & Pedrazzini AG, 8027 Zürich
 Priorität: EM, 04.05.2007

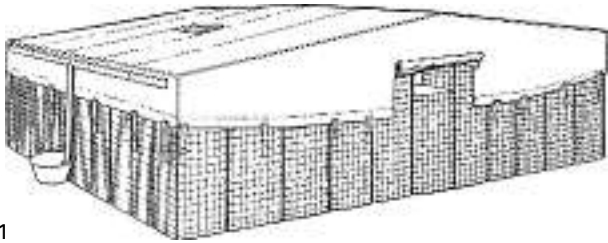
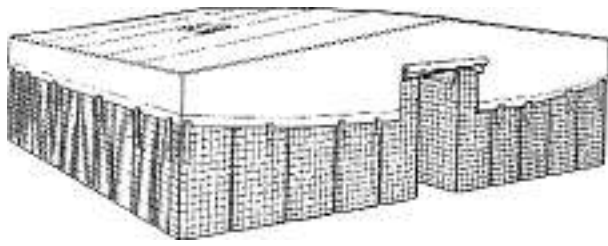

1

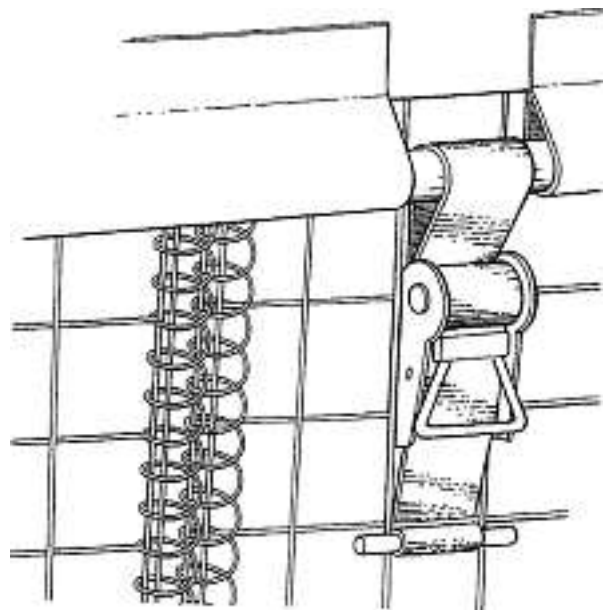

2

Cl. 26-05 **134 527** 17.10.2007
 2 Design – Hängeleuchte
 Hinterleger: Zumtobel Lighting GmbH, Schweizer Strasse 30,
 Dornbirn, AT
 Designer: Thomas Möritz, Berlin
 Vertreter: A. Braun, Braun, Héritier, Eschmann AG,
 Patentanwälte, 4051 Basel
 Priorität: EM, 17.04.2007

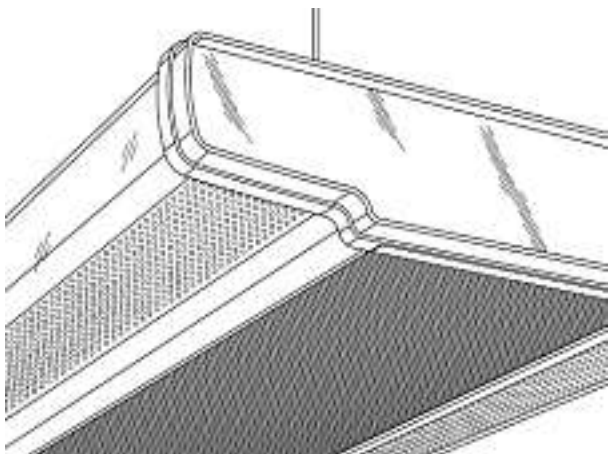
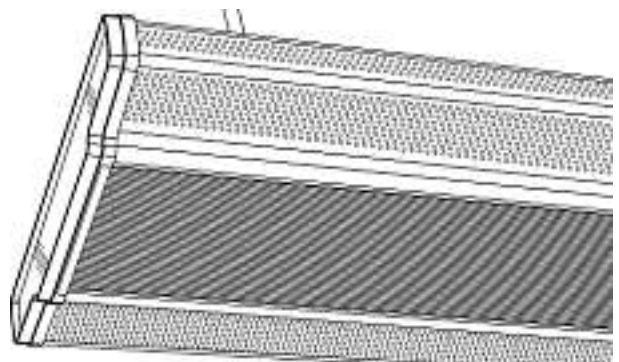
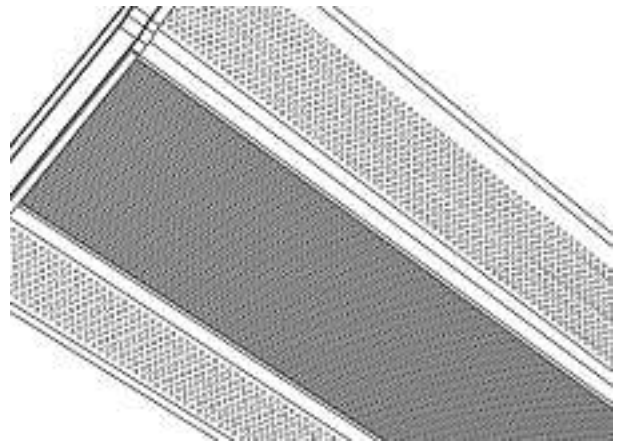
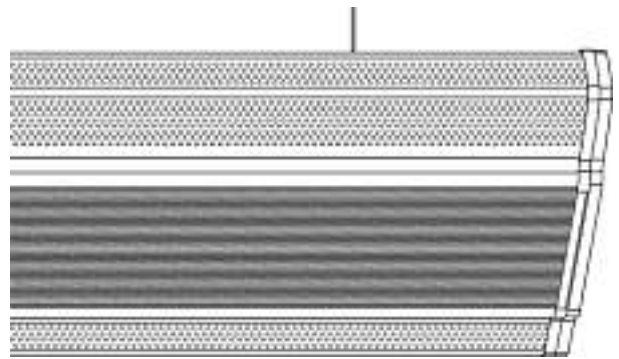
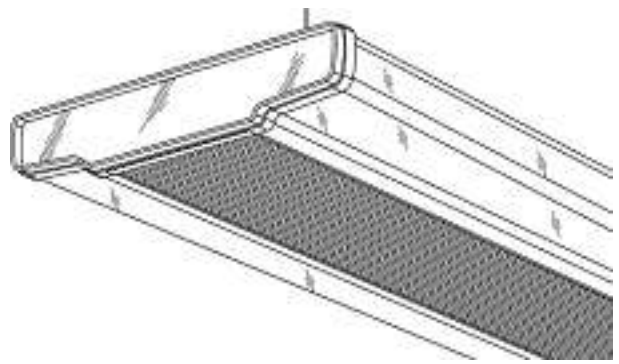

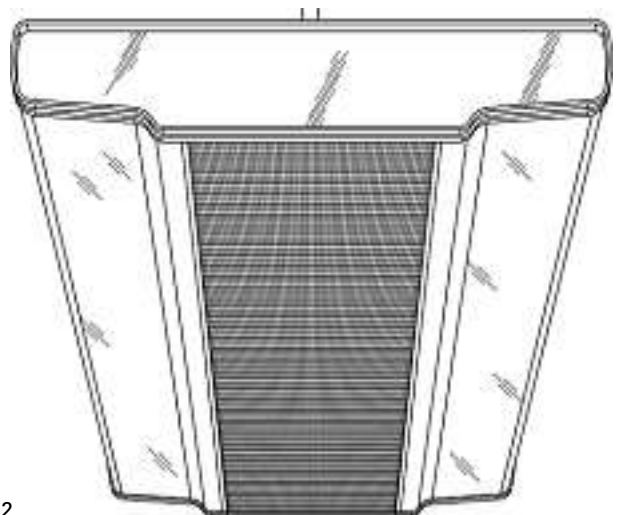
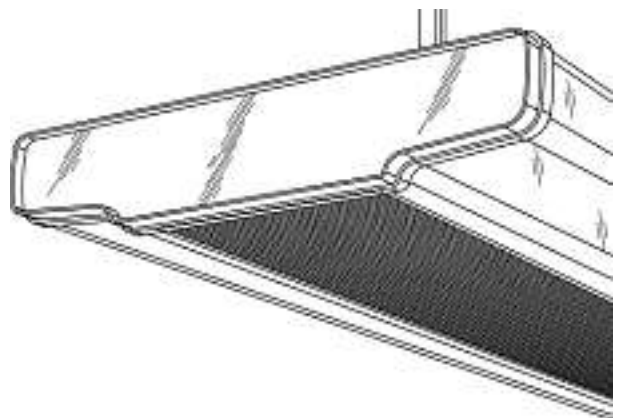
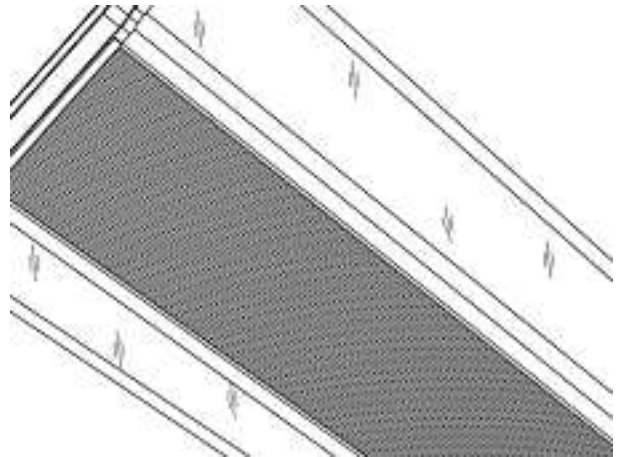
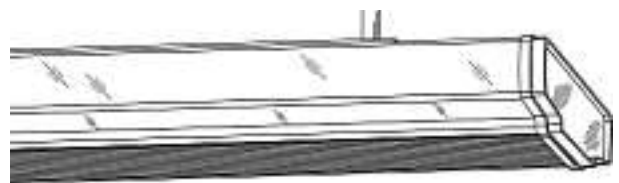
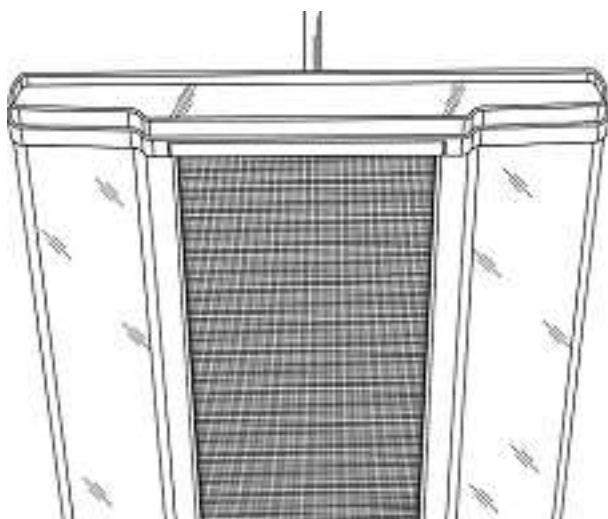
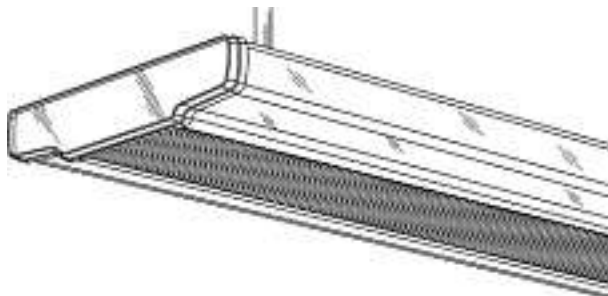
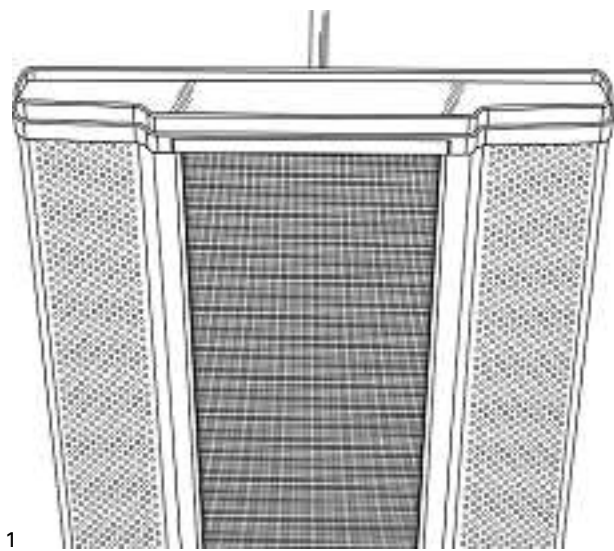

Cl. 26-05 **134 528** 17.10.2007
 3 Design – Reflektorelemente für Leuchten
 Hinterleger: Zumtobel Lighting GmbH & Co. KG,
 Grevenmarschstrasse 74-78, Lemgo, DE
 Designer: Rashid Hani, New York
 Vertreter: A. Braun, Braun, Héritier, Eschmann AG,
 Patentanwälte, 4051 Basel
 Priorität: EM, 17.04.2007

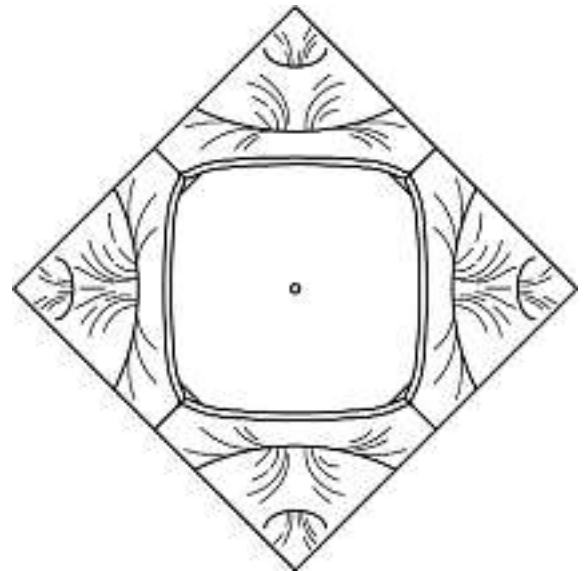
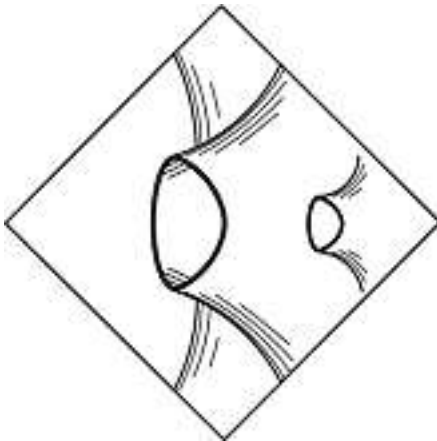
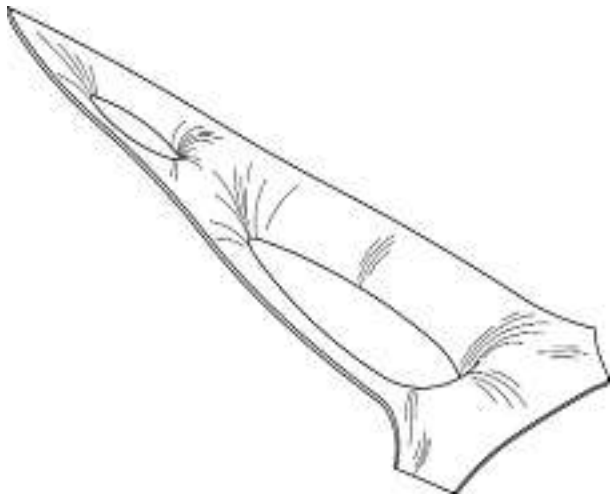

1

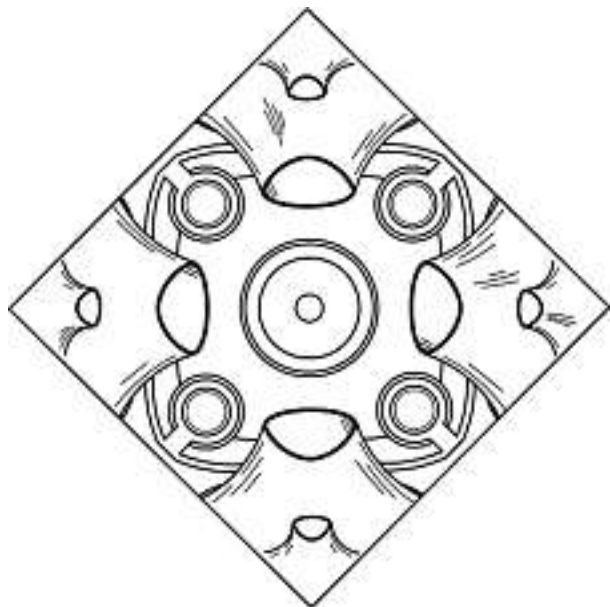

2

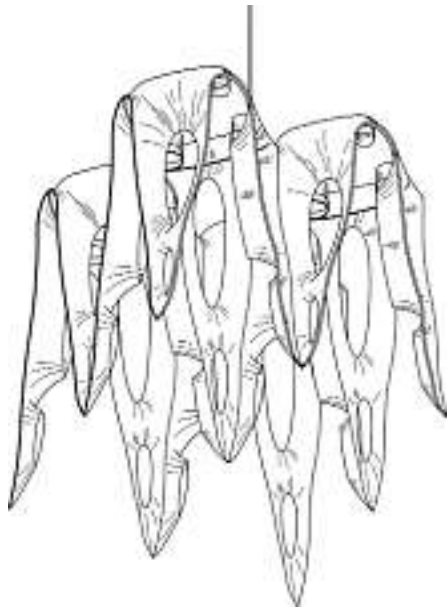

3

Cl. 31-00 **134 529** 26.11.2007
1 design – distributeur de boissons
Déposant: Société des Produits Nestlé SA, 1800 Vevey
Designer: Craig Jones, Leicester; Jonathan Ashbridge,
Leicester
Mandataire: Nestec S.A., 1800 Vevey

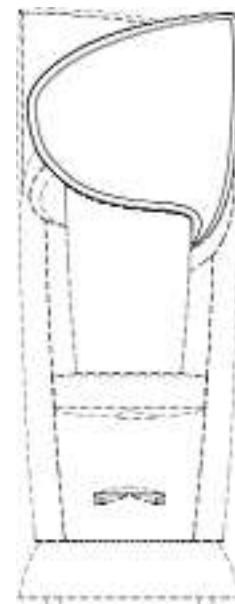
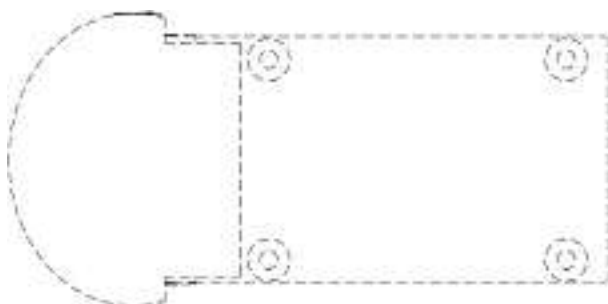
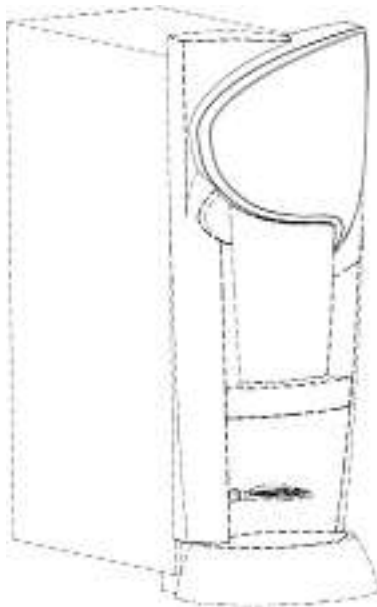
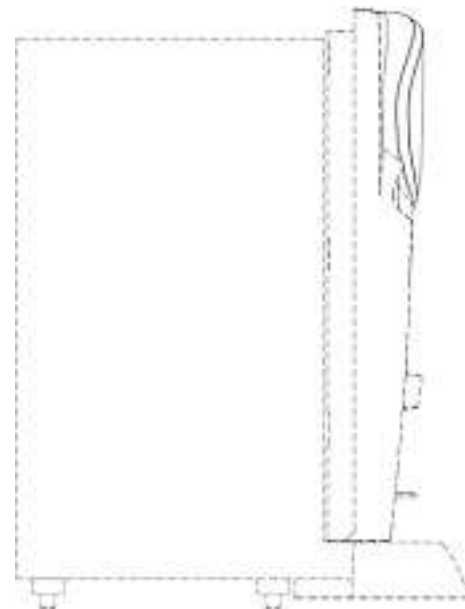
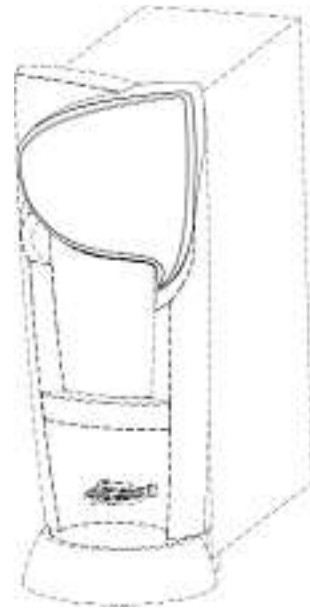

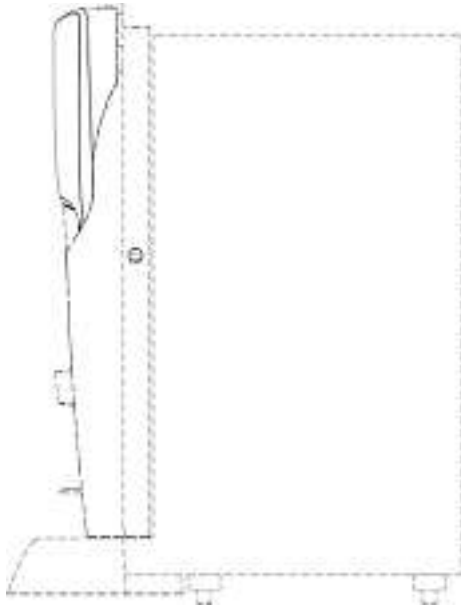

FL 69424

Verlängerungen
Prolongations
Prolongazioni

116 597 Cl. 14-03
120 076 Cl. 14-03

1 Design
1 Design

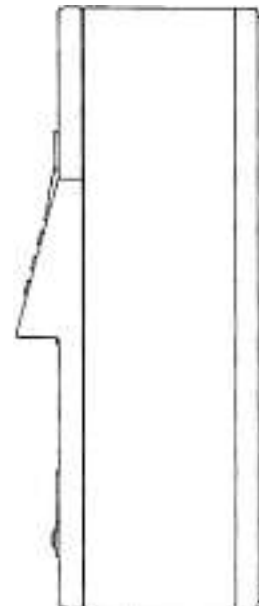
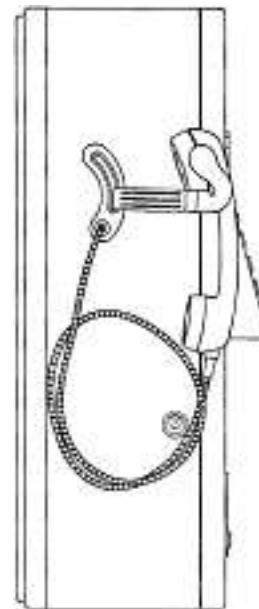
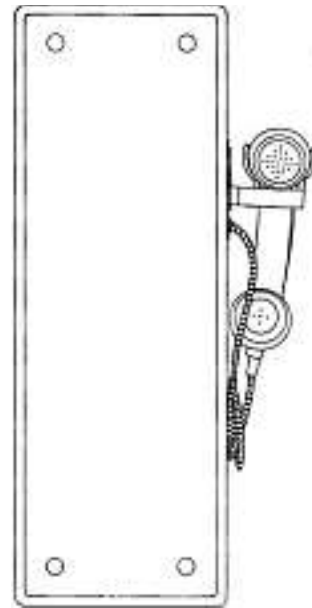
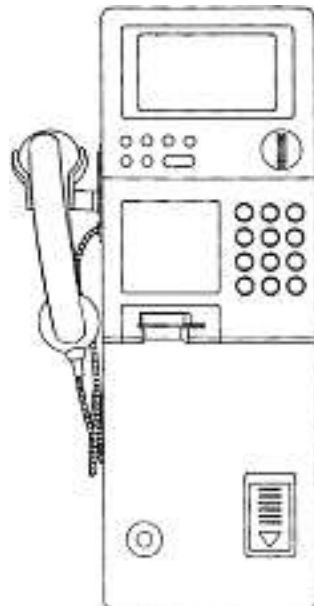

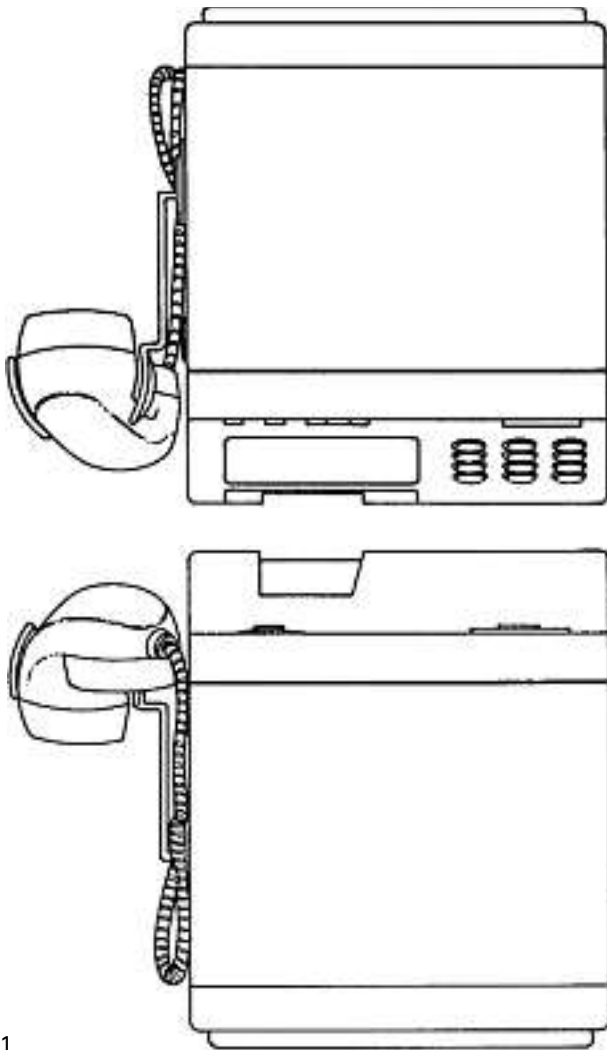

1

120 077 Cl. 14-03 1 Design

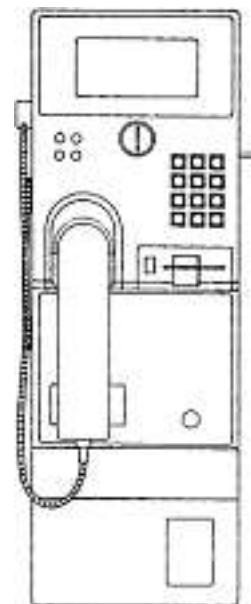
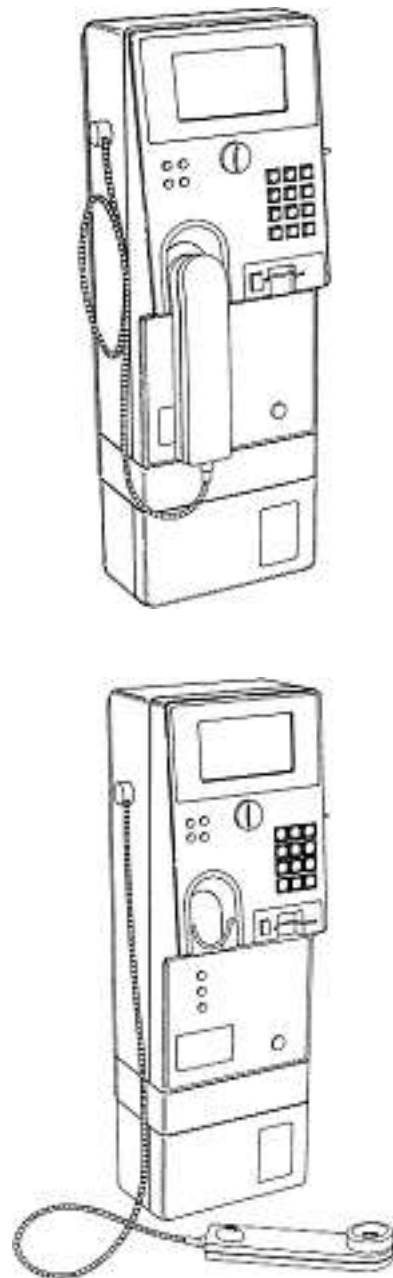
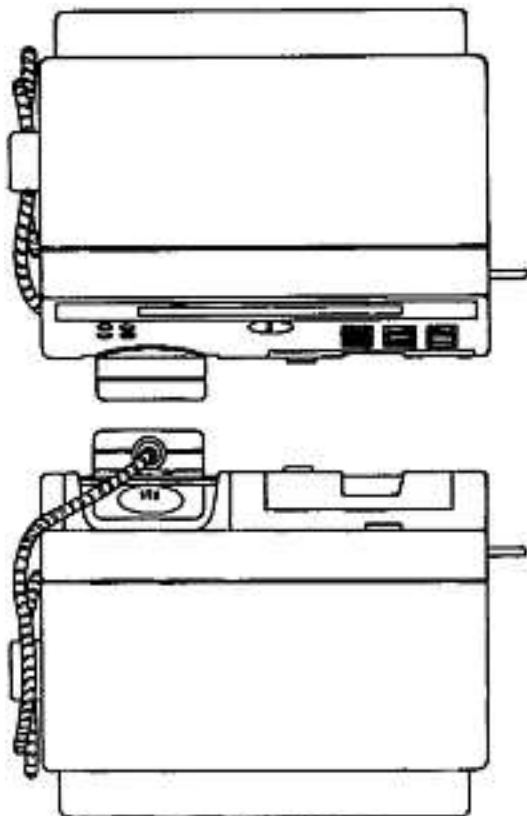

120 078 Cl. 14-03 1 Design

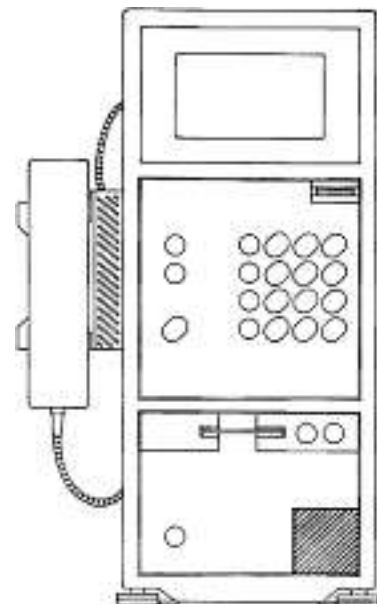
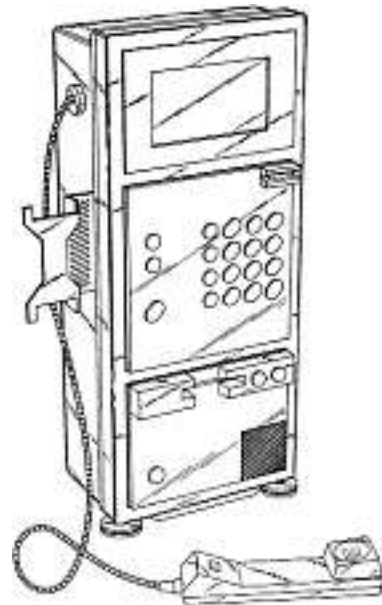
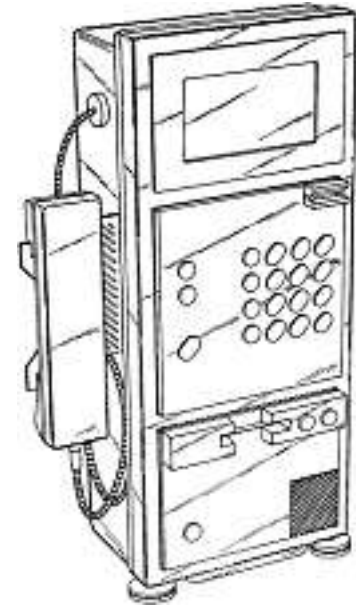
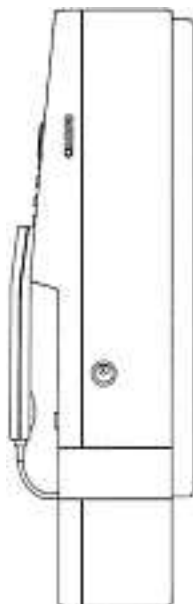
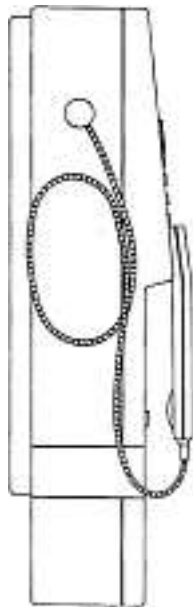

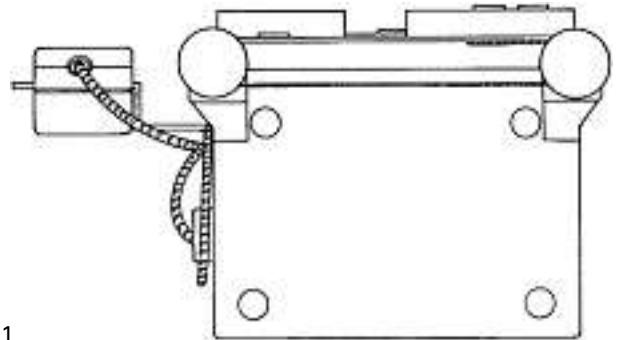
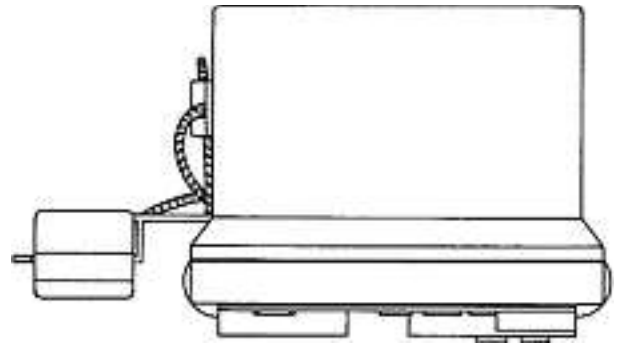
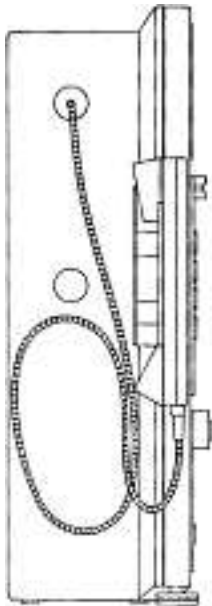
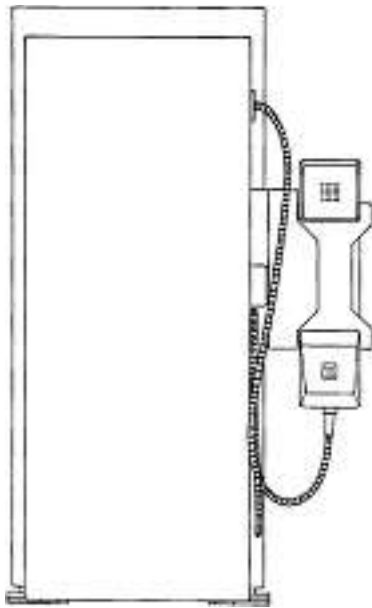

1

120 079 Cl. 14-03 1 Design

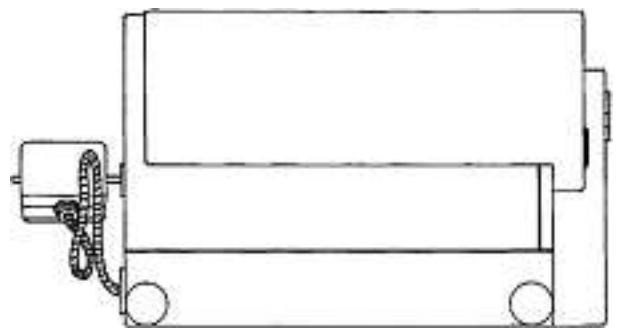

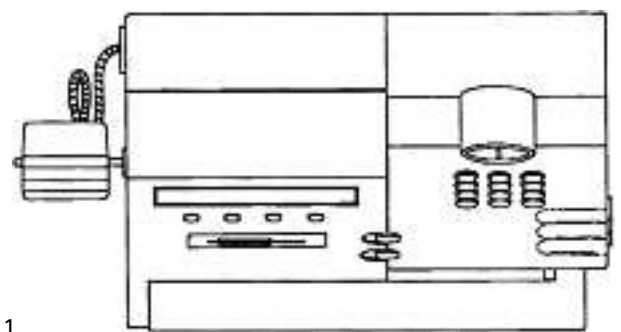
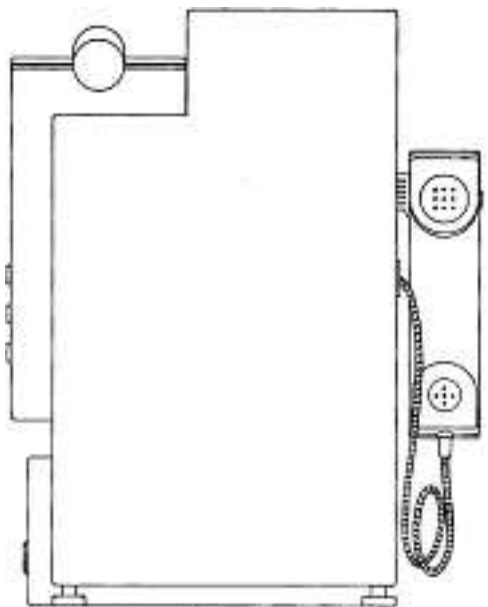
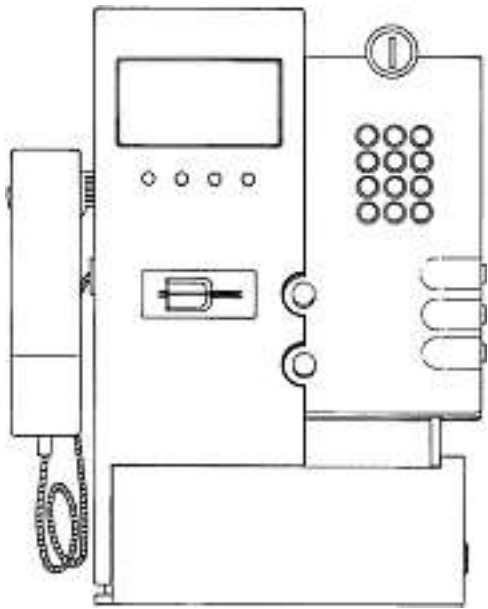
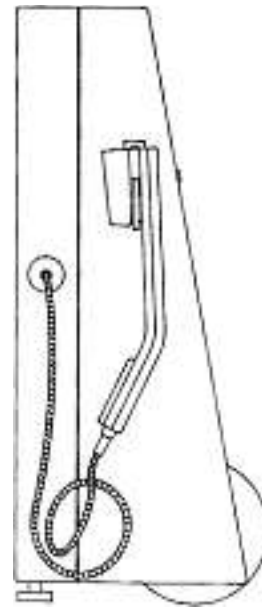

1

120 080 Cl. 14-03 1 Design

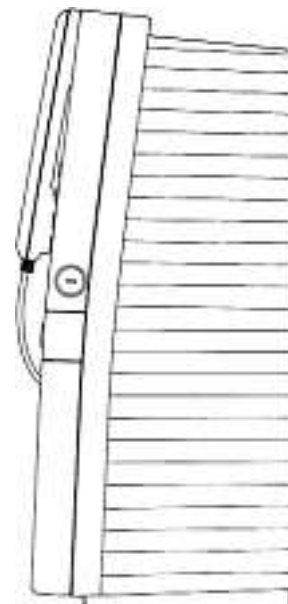
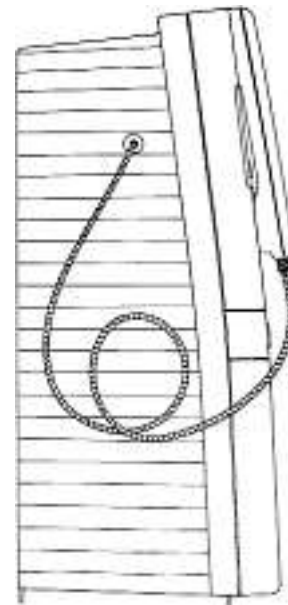
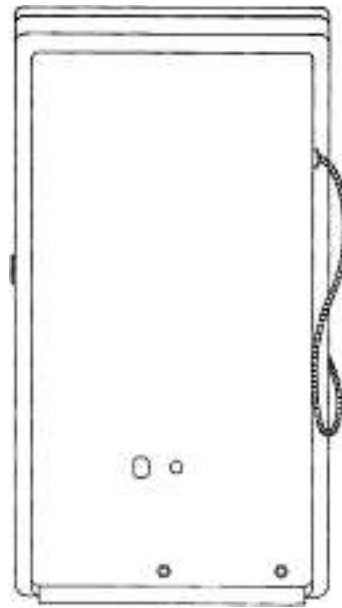
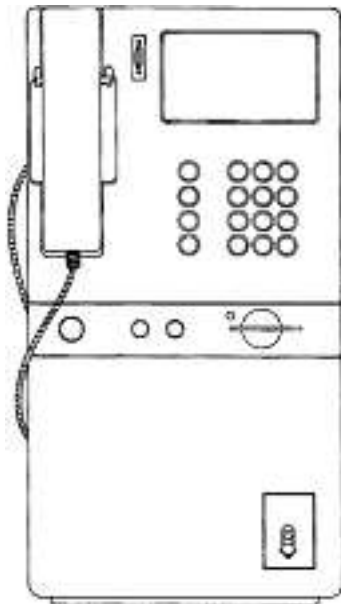
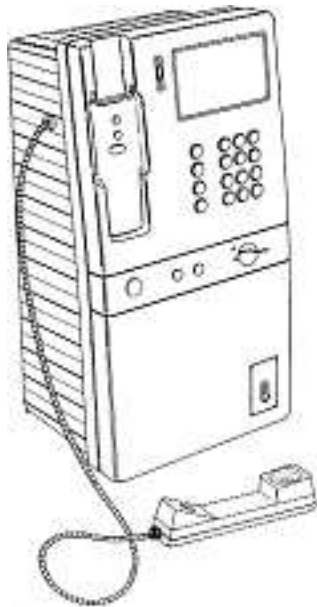
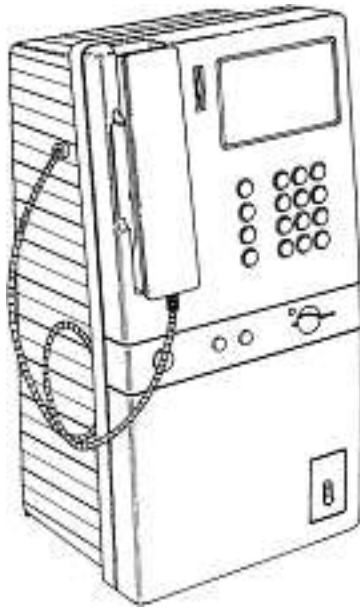

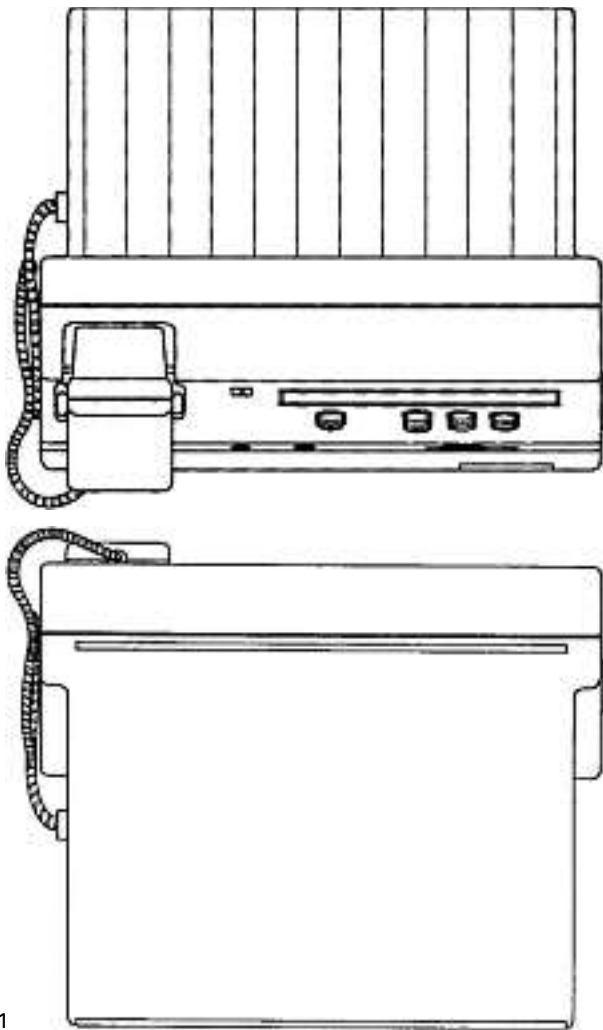

1

120 154 Cl. 16-06 2 Design

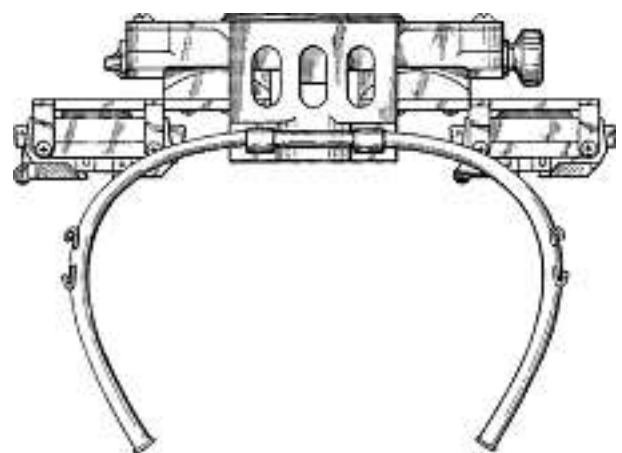
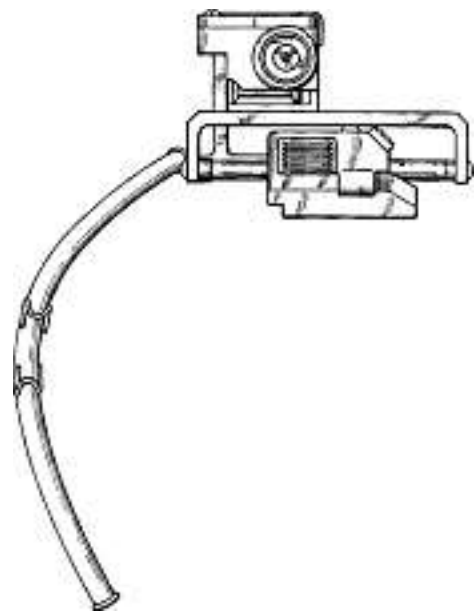
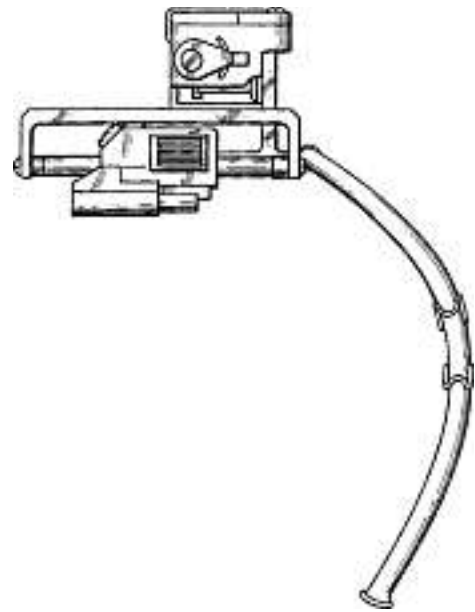
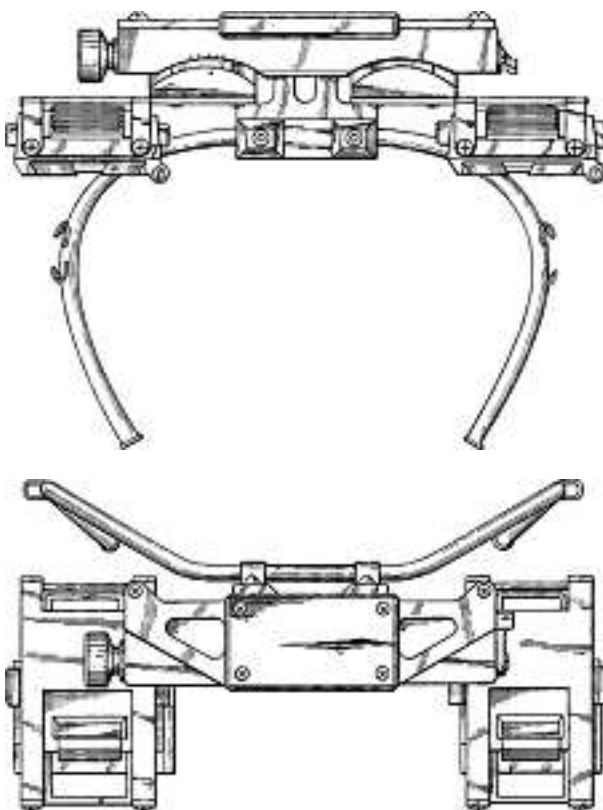

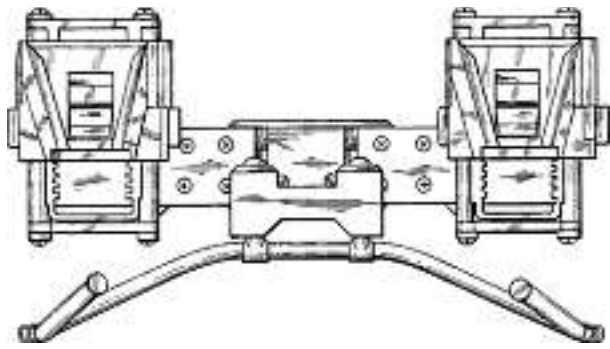

125

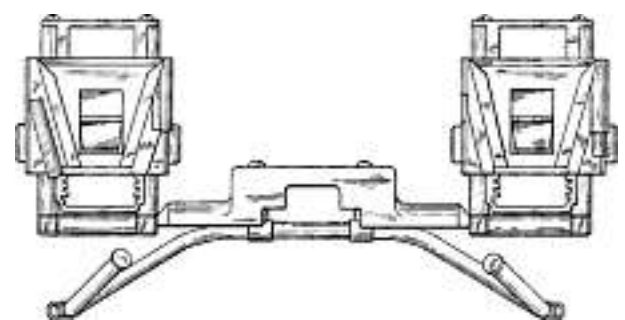
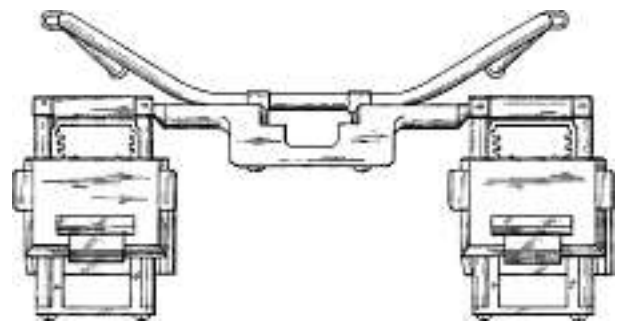
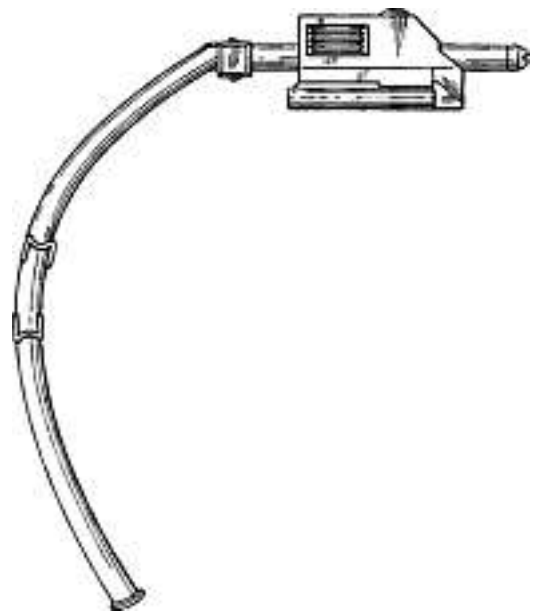
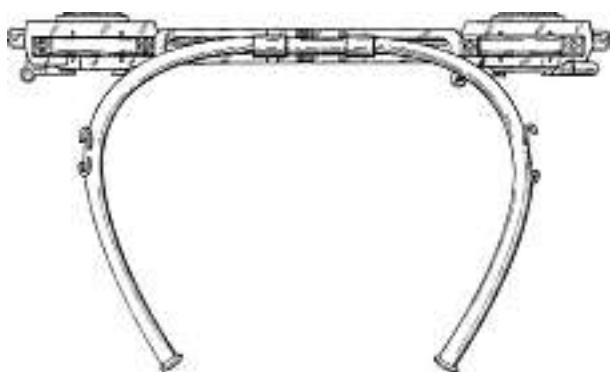
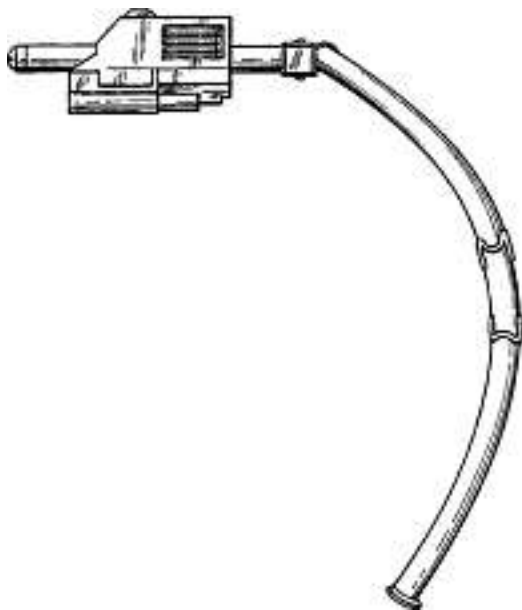

125

120 225 Cl. 14-99 2 Design

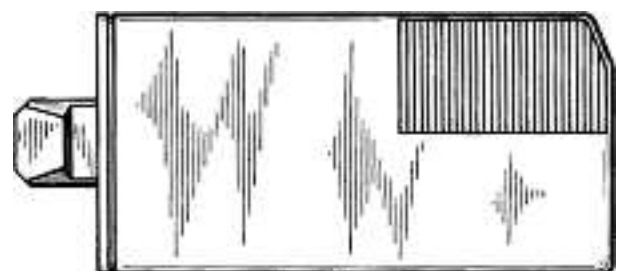

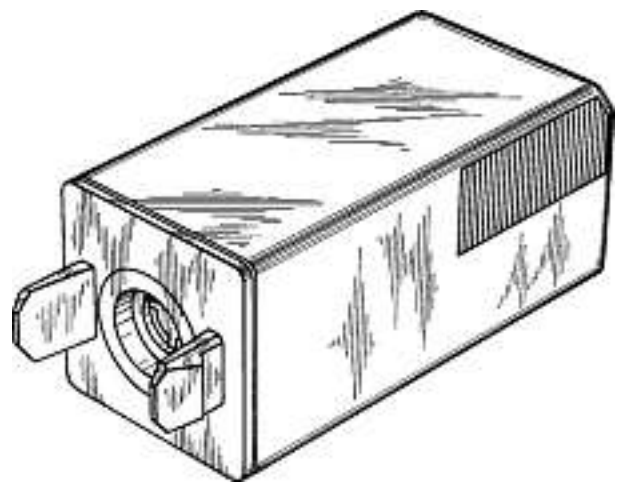
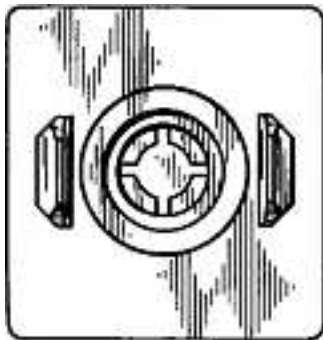
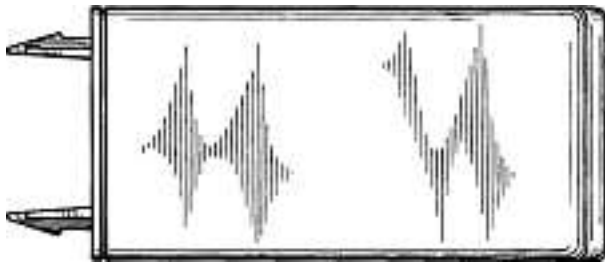

1



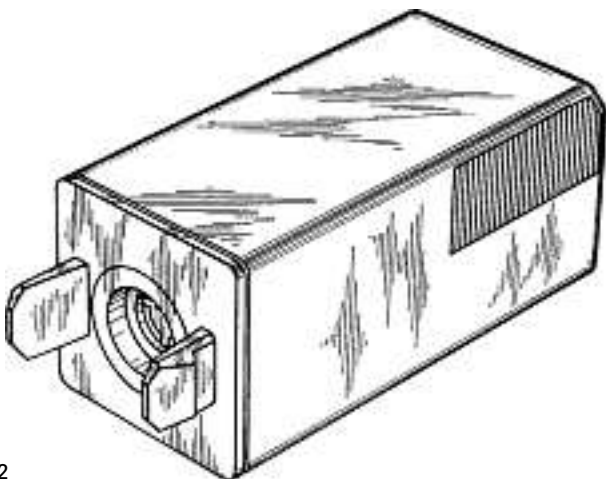
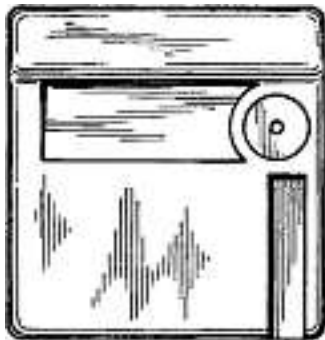
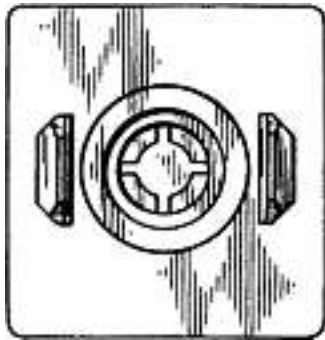

2

120 252 Cl. 11-02
1 (siehe Farbteil Heftmitte)

1 Design

120 254 Cl. 16-03 1 Design

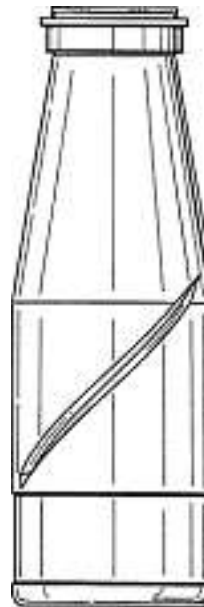

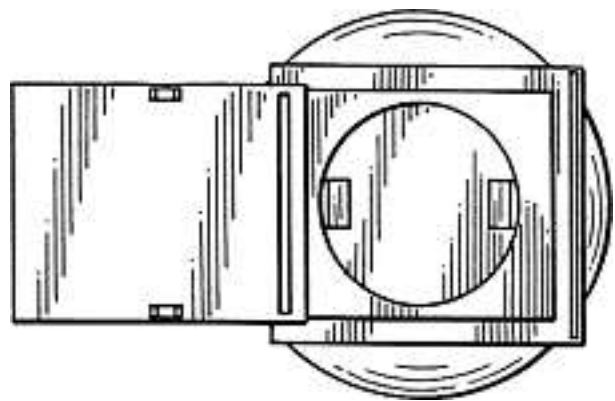
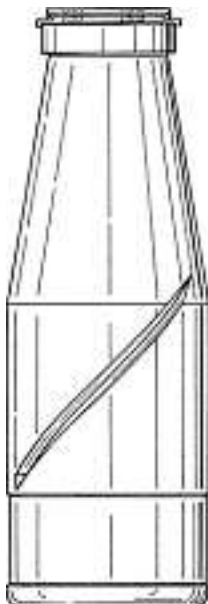
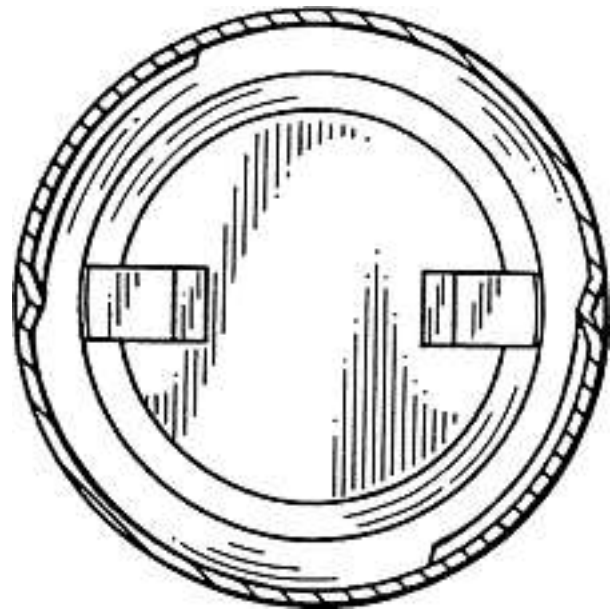
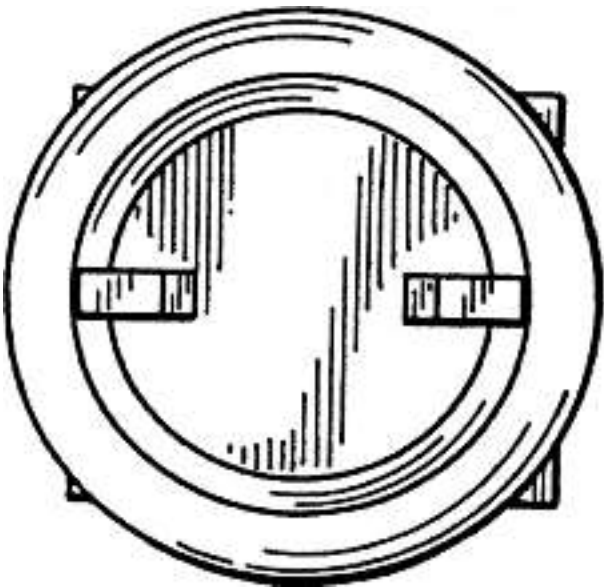
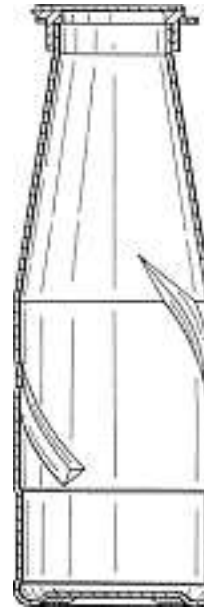
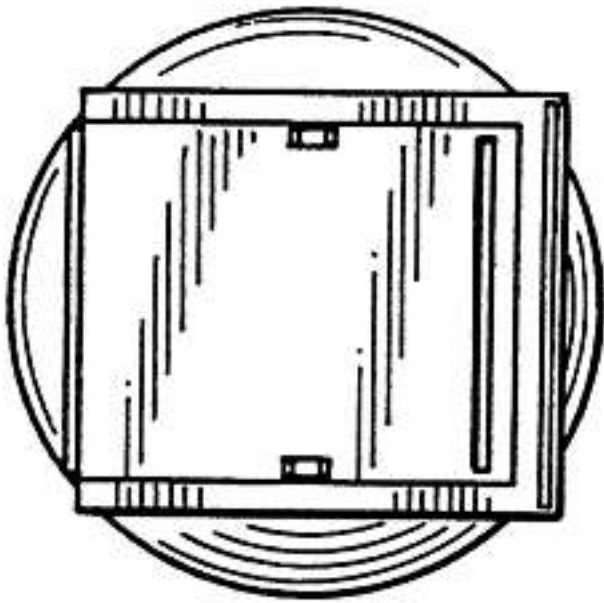

1

124 582	Cl.	28-03	1 Design
124 637	Cl.	09-03	1 Design
124 695	Cl.	25-02	1 design
124 696	Cl.	25-03	2 Design
124 709	Cl.	07-99	2 Design
124 731	Cl.	04-01	1 Design

124 749	Cl.	11-02	1 Design
124 785	Cl.	08-03	6 Design
124 793	Cl.	12-14	1 Design
124 803	Cl.	03-01	1 Design
124 900	Cl.	13-01	1 Design
124 904	Cl.	14-03	1 Design
124 985	Cl.	13-03	2 Design
125 018	Cl.	08-08	5 Design
129 247	Cl.	24-04	1 design
129 361	Cl.	09-03	2 design
129 394	Cl.	12-05	1 Design
129 559	Cl.	10-02	4 Design
129 561	Cl.	10-07	21 Design
129 562	Cl.	10-07	13 design

Mutationen Modifications Modificazioni

116 388

117 252

117 469

120 953

122 141

123 650

123 814

124 053

124 497

124 727

124 775

124 930

125 314

126 041

126 042

126 113

126 114

126 115

126 160

126 198

126 260

126 522

126 523

126 816

127 048

127 065

127 066

127 098

127 099

127 207

127 208

127 321

127 337

127 744

127 910

128 002

128 003

128 306

128 741

128 893

129 115

129 803

129 836

130 144

130 145

130 479

131 148

131 252

131 304

Vertreter Firmaänderung

Vertreter: Braunpat Braun Eder AG, 4054 Basel

127 651

127 940

128 674

Transmission

Déposant: NunnaUuni Oy, Joensuuentie 1344 C,
83940 Nunnanlahti, FI

Mandataire: Bugnion S.A., 1211 Genève 12 - Champel

131 967

Übertragung

Hinterleger: TRILUX GmbH & Co. KG, Heidestrasse 4,
59759 Arnsberg, DEVertreter: Schneider Feldmann AG, Patent- und
Markenanwälte, 8022 Zürich

**Löschungen
Radiations
Radiazioni**

119 713	Cl.	14-02	1 Design
119 723	Cl.	03-01	1 Design
124 121	Cl.	06-01	5 Design
124 160	Cl.	02-04	7 Design
124 168	Cl.	07-02	1 Design
124 180	Cl.	11-02	17 Design
124 189	Cl.	23-01	1 Design
124 210	Cl.	07-01	7 Design
124 331	Cl.	07-04	1 Design
128 746	Cl.	06-01	1 Design
128 747	Cl.	06-03	2 Design
128 753	Cl.	07-02	1 Design
128 762	Cl.	10-01	4 Design
128 764	Cl.	10-02	1 design
128 771	Cl.	19-08	1 Design
128 780	Cl.	02-04	1 Design
128 782	Cl.	03-01	1 Design
128 783	Cl.	06-01	1 Design
128 784	Cl.	06-01	1 Design
128 785	Cl.	06-01	2 Design
128 788	Cl.	06-03	4 Design
128 789	Cl.	06-04	2 Design
128 796	Cl.	10-02	6 design
128 798	Cl.	11-01	1 Design
128 804	Cl.	19-04	1 design
128 809	Cl.	26-01	1 Design
128 934	Cl.	04-02	1 Design

Cl. 23-01

133 697

27.02.2007





1





CI. 09-01 134 494 25.10.2007





Vivara

Cl. 10-02, 10-07

134 501

09.10.2007

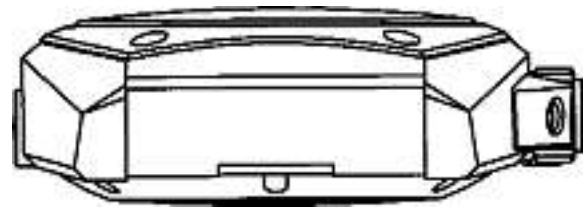
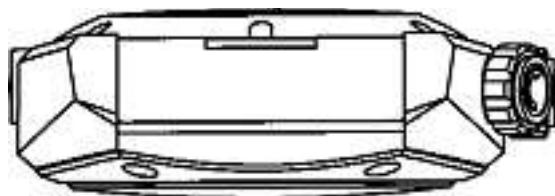
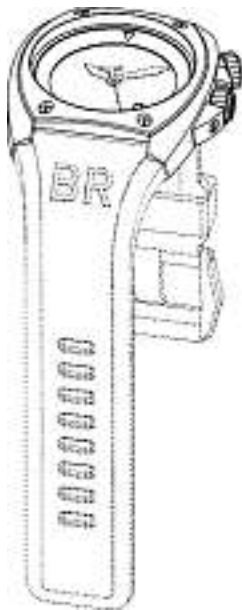

0019-030.D.CH-1

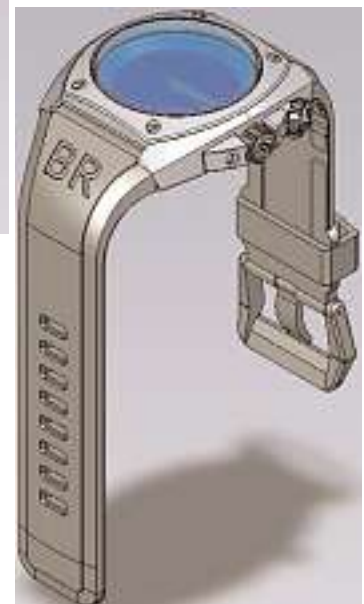



0019-030.D.CH-2

Cl. 19-08

134 518

08.11.2007



FL 69223/1



FL 69223/2



Cl. 19-08

134 519

03.12.2007

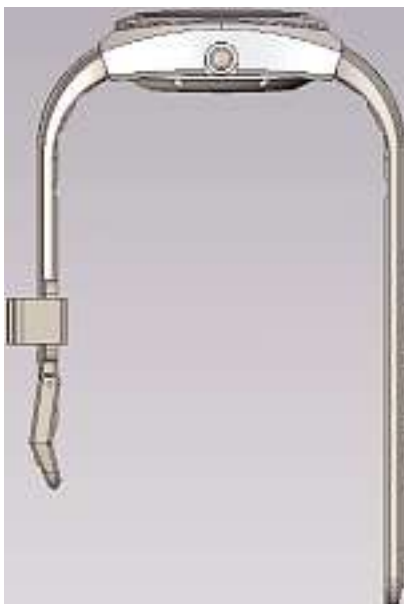

1

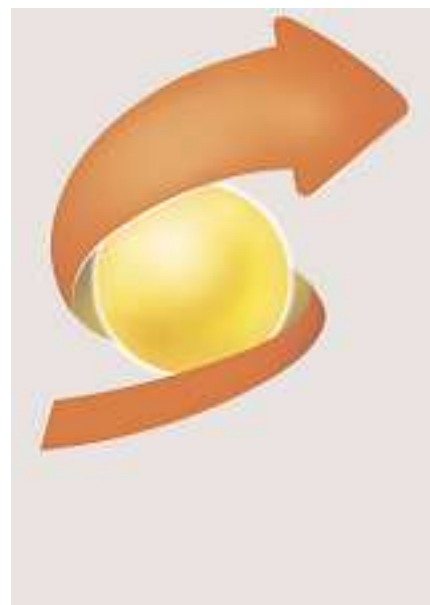



2



5



3



6



4



7



Cl. 21-02

134 521

06.11.2007



1



2



Cl. 24-99

134 524

12.11.2007

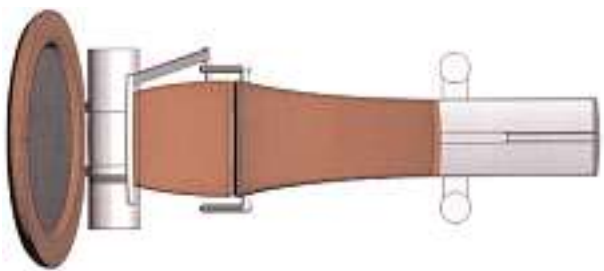

3





1

120 252 Cl. 11-02 1 Design

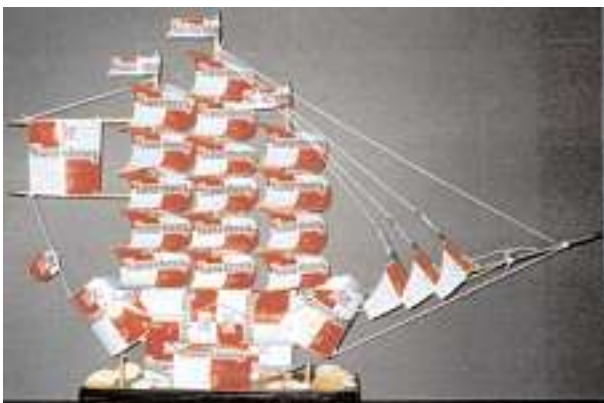

1