

Nationale Hinterlegungen

In der folgenden Liste werden die beim Eidgenössischen Institut für Geistiges Eigentum hinterlegten Designs publiziert. Dabei sind der Reihe nach angegeben:

- internationale Klassenangaben
- Hinterlegungsnummer
- Hinterlegungsdatum
- Allenfalls Aufschub der Veröffentlichung
- Anzahl der hinterlegten Designs
- Bezeichnung
- Name und Wohnsitz des Hinterlegers oder der Hinterlegerin
- gegebenenfalls Name und Wohnsitz des Designers oder der Designerin
- Name und Geschäftssitz des allfälligen Vertreters oder der Vertreterin
- gegebenenfalls Prioritätsangaben
- gegebenenfalls Beschreibungstext
- Ordnungsnummer
- Reproduktion des Designs

Internationale Hinterlegungen

Die bei der Weltorganisation für geistiges Eigentum in Genf hinterlegten Muster und Modelle mit Benennung Schweiz geniessen den gleichen Schutz wie national hinterlegte Designs. Sie werden jeweils im Blatt «Bulletin des dessins et modèles internationaux» veröffentlicht. Dieses Publikationsorgan ist deshalb für eine vollständige Recherche unbedingt beizuziehen.

Topographien

Angaben über die vom Eidgenössischen Institut für Geistiges Eigentum eingetragenen Topographien von Halbleitererzeugnissen werden in folgender Anordnung aufgeführt:

- Eintragsnummer
- Anmeldedatum
- Bezeichnung
- Name und Wohnsitz des Anmelders oder der Anmelderin
- gegebenenfalls Name und Wohnsitz des Herstellers oder der Herstellerin
- Name und Geschäftssitz des oder der allfälligen Bevollmächtigten
- Datum und Ort einer allfälligen ersten geschäftlichen Verbreitung der Topographie

Dépôts nationaux

Les designs déposés à l'Institut Fédéral de la Propriété Intellectuelle sont publiés dans la liste qui suit. Les indications y relatives sont mentionnées dans cet ordre:

- indications des classes internationales
- numéro de dépôt
- date de dépôt
- le cas échéant, ajournement de la publication
- nombre des designs déposés
- désignation
- nom et domicile du/de la déposant/e
- le cas échéant, nom et domicile du/de la designer
- nom et domicile de l'éventuel/le mandataire
- le cas échéant, indication de priorité
- le cas échéant, description du design
- numéro attribué à chaque design
- reproduction du design

Dépôts internationaux

Les dessins et modèles déposés à l'Organisation Mondiale de la Propriété Intellectuelle à Genève qui désignent la Suisse jouissent de la même protection que les dépôts nationaux. Ils sont chaque fois publiés dans la feuille «Bulletin des dessins et modèles internationaux». Pour une recherche complète, il est indispensable de consulter ledit organe de publication.

Topographies

Les indications concernant les topographies des produits semi-conducteurs, enregistrées par l'Institut Fédéral de la Propriété Intellectuelle, sont énumérées dans l'ordre suivant:

- numéro d'enregistrement
- date de dépôt
- désignation
- nom et domicile du/de la déposant/e
- le cas échéant, nom et domicile du/de la producteur/trice
- nom et domicile de l'éventuel/le mandataire
- date et lieu d'une éventuelle première mise en circulation de la topographie

Depositi nazionali

Nella lista seguente vengono pubblicati i design depositati presso l'Istituto Federale della Proprietà Intellettuale. Sono menzionati nel seguente ordine:

- indicazioni delle classi internazionali
- numero di deposito
- data del deposito
- se del caso, indicazione che la pubblicazione è stata differita
- numero dei design depositati
- designazione
- nome e domicilio del depositante
- se del caso, nome e domicilio del designer
- nome e sede di un eventuale mandataro
- se del caso, indicazioni di priorità
- se del caso, descrizione del design
- numero d'ordine
- riproduzione del design

Depositi internazionali

I disegni e modelli depositati presso l'Organizzazione Mondiale della Proprietà Intellettuale a Ginevra con denominazione Svizzera godono della medesima protezione del deposito nazionale. Essi vengono pubblicati ogni volta nel foglio «Bulletin des dessins et modèles internationaux». Quest'organo di pubblicazione è da consultare se si vuole effettuare una ricerca completa.

Topografie

Le indicazioni concernenti le topografie di prodotti a semiconduttori depositati presso l'Istituto Federale della Proprietà Intellettuale sono menzionate nell'ordine seguente:

- numero di registrazione
- data del deposito
- designazione
- nome e domicilio del/la richiedente
- se del caso, nome e domicilio del/la produttore/trice
- nome e sede di un eventuale mandataro
- data e luogo di un'eventuale prima messa in circolazione della topografia

**Hinterlegungen
Dépôts
Deposit**

Cl. 04-02 133 229 16.10.2006

4 Design – Zahnbürsten

Hinterleger: Trisa Holding AG, Kantonsstrasse, 6234 Triengen
Designer: Martin Zwimpfer, Luzern; Armin Bärtschi, Winznau
Vertreter: Patentanwälte Schaad, Balass, Menzl & Partner AG,
8034 Zürich

Ende aufgeschobene Publikation

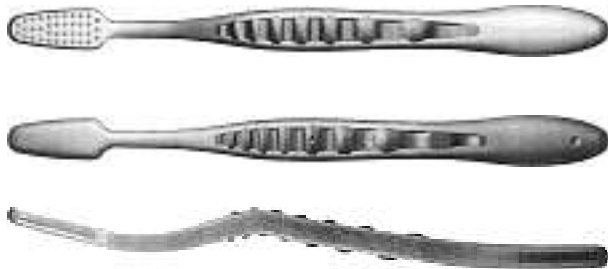

1

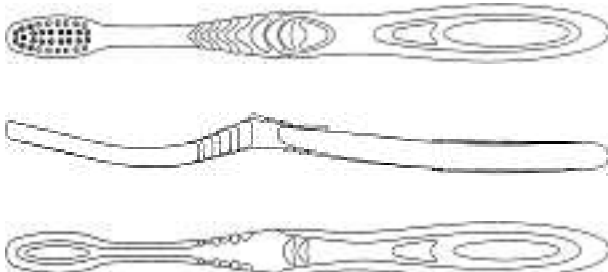

2

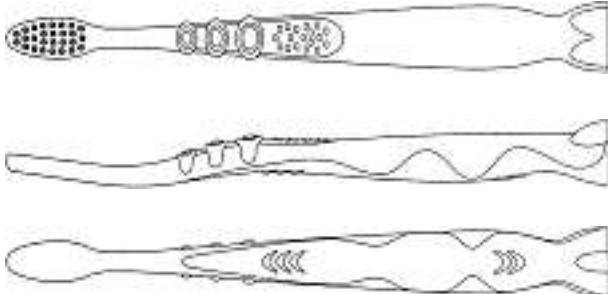

3

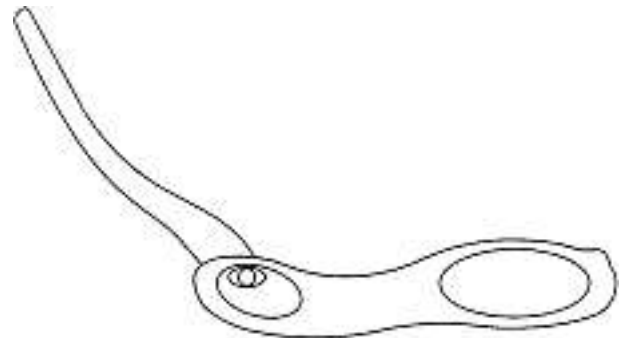
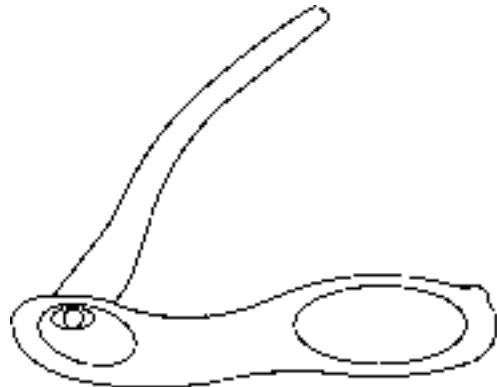
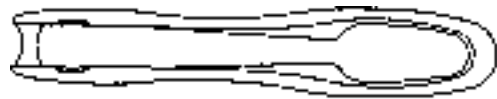
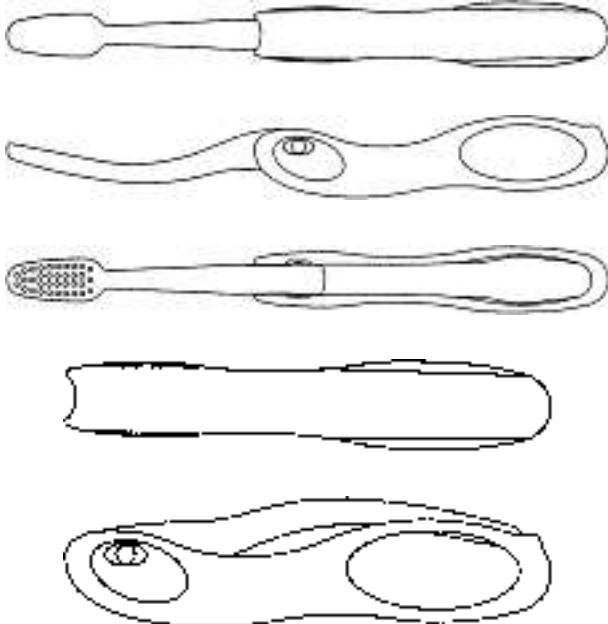

4

Cl. 10-02 133 726 26.03.2007

1 design – montre-bracelet

Déposant: Desco von Schulthess AG, Brandschenkestrasse 2,
8002 Zürich

Designer: Sandro Reginelli, Neuchâtel

Mandataire: Inteltech SA, 2001 Neuchâtel

Fin de la période ajournement de la publication





Cl. 02-07 134 382 12.10.2007
 1 design – boutons de manchettes
 Déposant: François-Paul Journe, 17, rue de l'Arquebuse,
 1204 Genève
 Mandataire: Inteltech SA, 2001 Neuchâtel
 Fin de la période ajournement de la publication

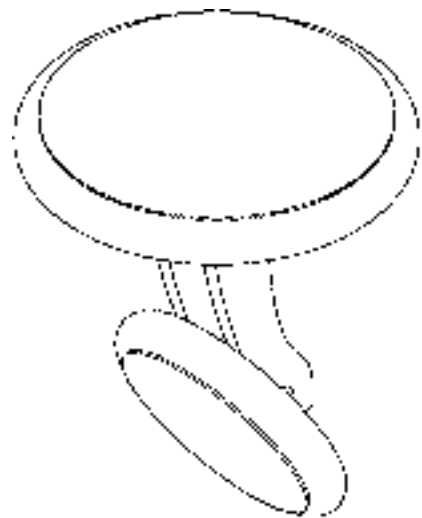
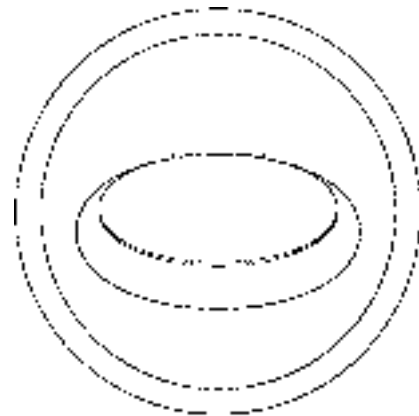
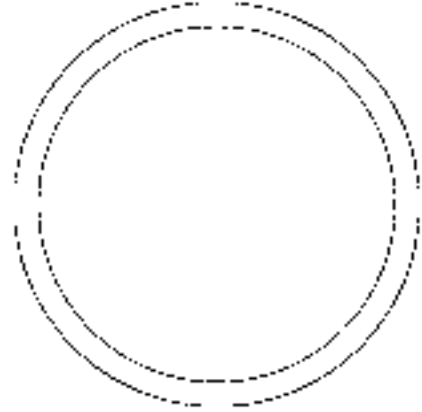

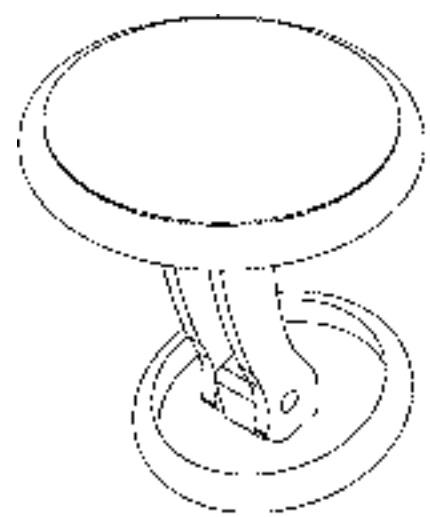
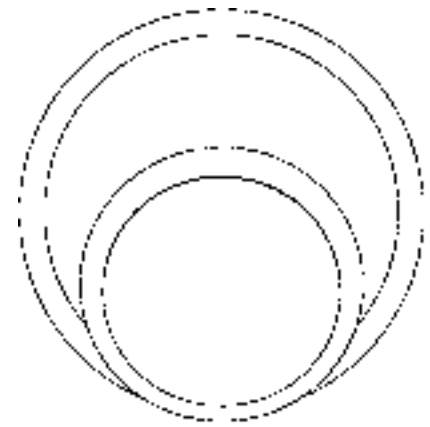
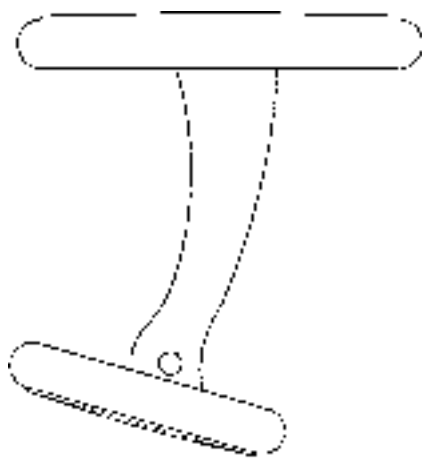
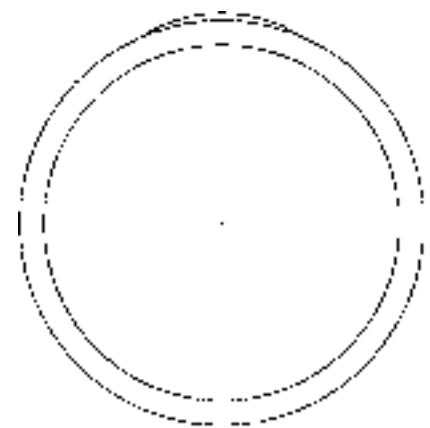
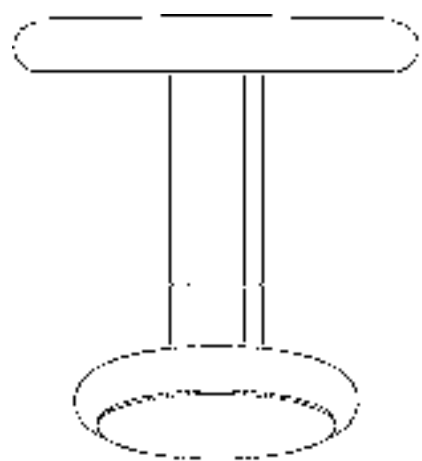
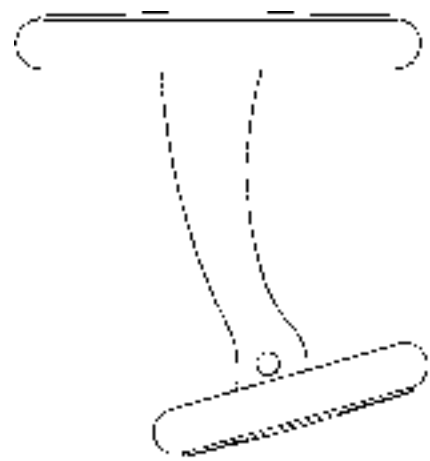
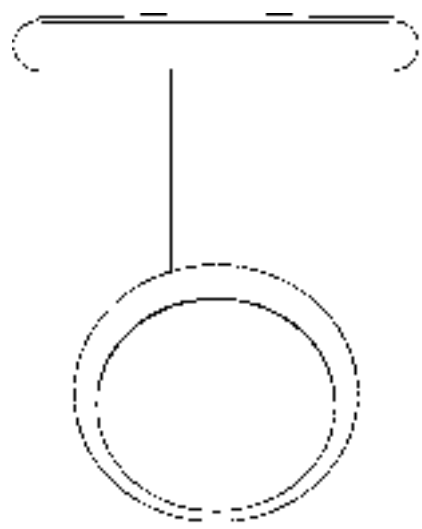

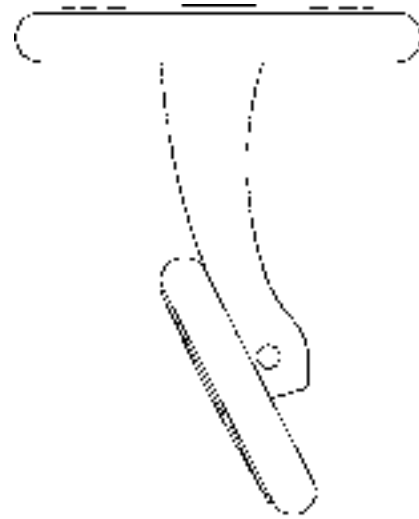
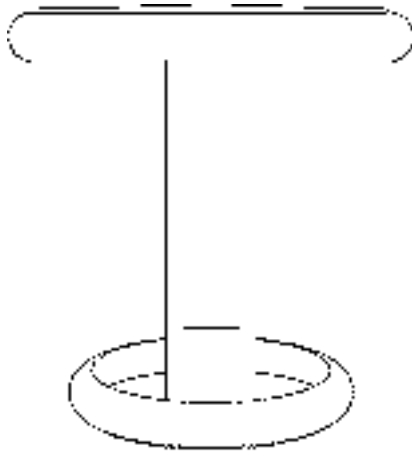

154260/010006

Cl. 01-01 **134 744** 24.01.2008

1 design – tablette de chocolat
 Déposant: Sonafi, 42, rue Rieussec, Viroflay, FR
 Designer: Sylvain Samarut, La Roche de Glun
 Mandataire: Inteltech SA, 2001 Neuchâtel
 Priorité: EM 10.08.2007
 158780/010001 (siehe Farbteil Heftmitte)

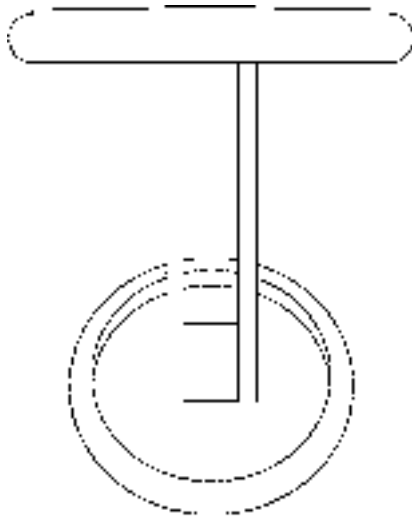

Cl. 01-01 **134 745** 20.02.2008

15 design – chocolats
 Déposant: Société des Produits Nestlé SA, 1800 Vevey
 Designer: Francis Lovell, Montreuil; Aurèle Hurtis, Nanterre;
 Christophe Hartmann, Epalinges
 Mandataire: Nestec S.A., 1800 Vevey



1

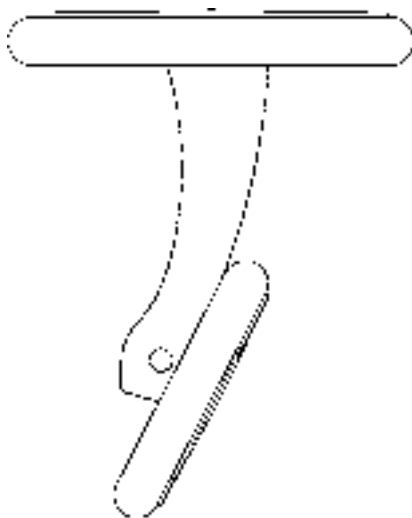

2



3



7



4



8



5



9



6



10



11



12



13



14



15

Cl. 03-01 **134 746** 16.01.2008
 3 design – porte-clefs
 Déposant: RODA SOCIETE ANONYME, Zone Artisanale
 d'Hachimette, 68650 Lapoutroie, FR
 Designer: Roger Voinson, Orbey
 Mandataire: Kirker & Cie S.A., Ingénieurs-Conseils,
 1226 Genève - Thônex
 4 (siehe Farbteil Heftmitte)
 5 (siehe Farbteil Heftmitte)
 6 (siehe Farbteil Heftmitte)

Cl. 03-01 **134 747** 29.01.2008
 2 Design – Schmuckdose
 Hinterleger: ASW Schwarzer GmbH, Untere
 Donnerbergstrasse 52, 52222 Stolberg, DE
 Designer: Werner Schwarzer, Stolberg
 Vertreter: Pestalozzi Lachenal Patry, 8001 Zürich
 Priorität: EM, 12.09.2007; EM 12.09.2007





fled34/3



fled34/4

Cl. 03-01 134 748 29.01.2008
 1 design – sac à dos
 Déposant: Sophie Dargent, 62, rue Liotard, 1203 Genève



easy 2wear

Cl. 03-03 134 749 12.09.2007
 1 Design – Sonnenschirm
 Hinterleger: Heinz Kettler GmbH & Co. KG, Hauptstrasse 28,
 59469 Ense-Parsit, DE
 Designer: Bernhard Haakshorst, Werl; Gido Golling,
 Martinsried
 Vertreter: Isler & Pedrazzini AG, 8027 Zürich
 Priorität: EM 12.03.2007
 M13415 (siehe Farbteil Heftmitte)

Cl. 05-05 134 750 27.12.2007
 3 Design – Häkelstoffs
 Hinterleger: Ulrike Fischer, Kollwitzstrasse 10, 10405 Berlin, DE
 Vertreter: Walter Stüdeli, 3006 Bern
 Priorität: EM 20.08.2007

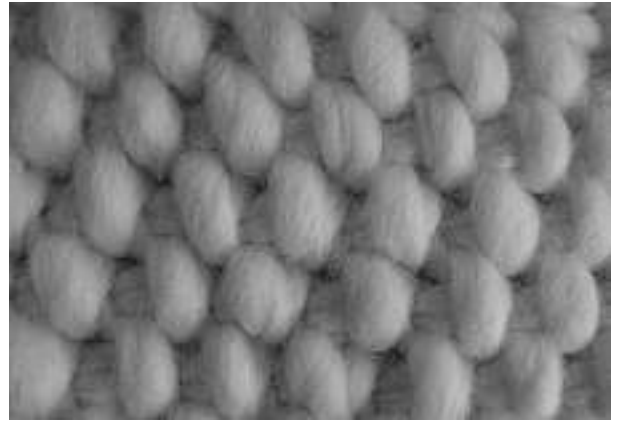
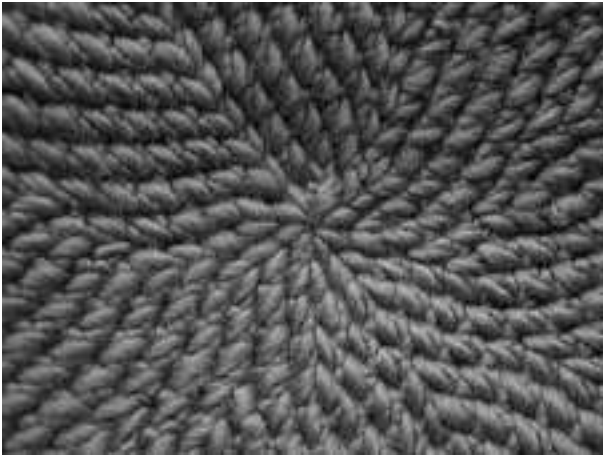

1

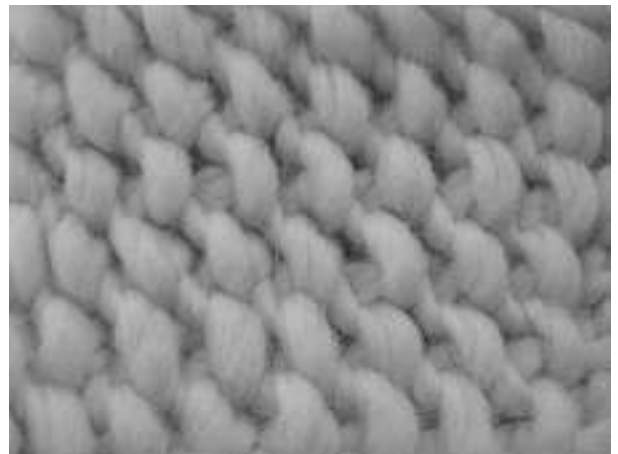
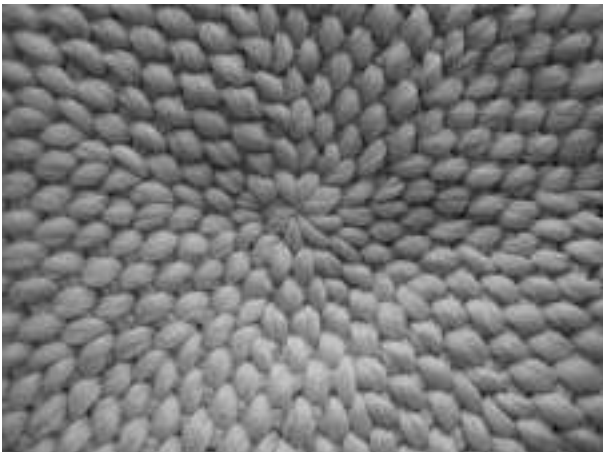
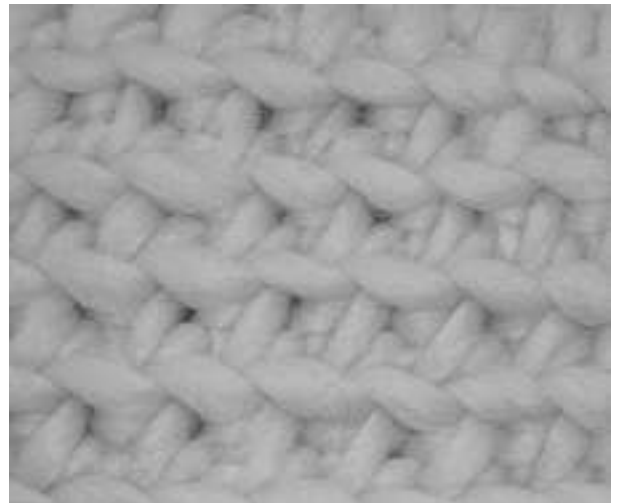
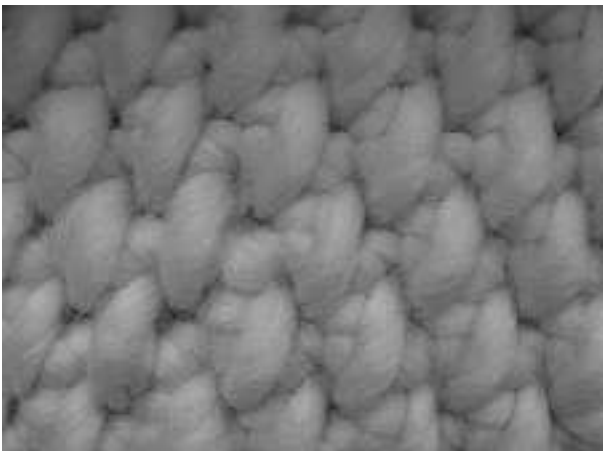

2



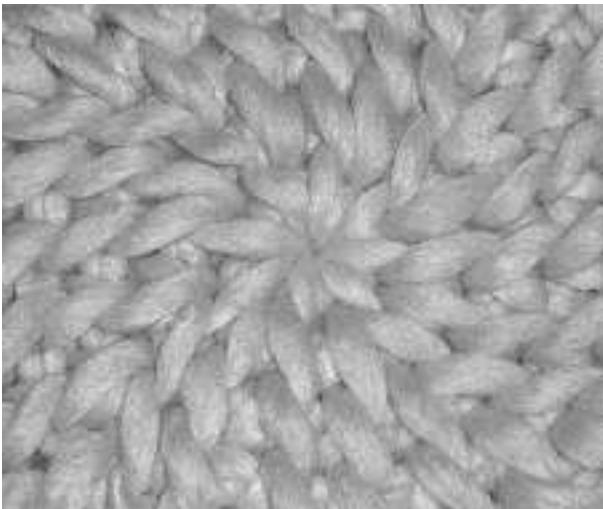

3

Cl. 06-01 **134 751** 11.01.2008
 1 Design – Sitzmöbel
 Hinterleger: MILES Fashion GmbH, Harckesheyde 91-93,
 22844 Norderstedt, DE
 Designer: Regine Böttner, Norderstedt
 Vertreter: Troesch Scheidegger Werner AG, Patent- und
 Markenanwälte, 8126 Zumikon
 Priorität: EM 07.12.2007
 D300229 (siehe Farbteil Heftmitte)

Cl. 06-01, 06-03 **134 752** 17.01.2008
 12 Design – Stühle, Bänke, Liegen, Tische
 Hinterleger: Peter Hintzen, Denkmalstrasse 21a, 41363
 Jüchen, DE
 Vertreter: PA Aldo Römpler, 9410 Heiden
 Priorität: EM 14.11.2007



1



2



3



5



4





6



7



8



9



10



11



12

Cl. 06-01 **134 753** 21.01.2008

10 design – chaises, chaise longue, banc, fauteuils, tabouret

Déposant: MWH-Metallwerk Helmstadt GmbH, Flinsbacher Strasse 1, Helmstadt, DE

Designer: Werner Rech, Illingen; Norbert Widmann, Hüffenhardt

Mandataire: reuteler & cie S.A., 1260 Nyon

Priorité: EM, 13.08.2007

1 (siehe Farbteil Heftmitte)

2 (siehe Farbteil Heftmitte)

3 (siehe Farbteil Heftmitte)

4 (siehe Farbteil Heftmitte)

5 (siehe Farbteil Heftmitte)

6 (siehe Farbteil Heftmitte)

7 (siehe Farbteil Heftmitte)

8 (siehe Farbteil Heftmitte)

9 (siehe Farbteil Heftmitte)

10 (siehe Farbteil Heftmitte)

Cl. 06-01 **134 754** 22.01.2008

1 Design – Sessel

Hinterleger: Intertime AG Polstermöbelfabrik,

Brühlstrasse 21, 5304 Endingen

Designer: Louis Schneider, Lengnau



2820

Cl. 06-01 **134 755** 22.01.2008

2 Design – Polstermöbel

Hinterleger: Intertime AG Polstermöbelfabrik, Brühlstrasse 21, 5304 Endingen

Designer: Matthias Weber, Zürich





2850.110/120 a



2850.110/120 b

Cl. 06-01 134 756 29.01.2008
2 Design – Stühle
Hinterleger: Rolf Benz AG & Co. KG, Haiterbacher Strasse 104,
72202 Nagold, DE
Designer: Georg Appelthausen, Stuttgart
Vertreter: Bovard AG, 3000 Bern 25
Priorität: EM 26.09.2007, EM 26.09.2007





300642-1



300642-2

Cl. 06-04 134 757 28.01.2008
1 Design – Regal
Hinterleger: Christian Winterhalder, Sulgenrain 25, 3007 Bern

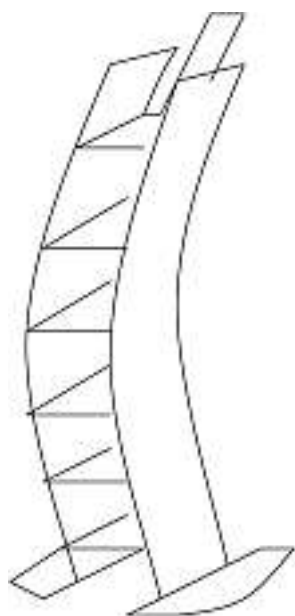

001

Cl. 06-09 134 758 16.01.2008
2 design – coussins
Déposant: RODA SOCIETE ANONYME, Zone Artisanale d'Hachimette, 68650 Lapoutroie, FR
Designer: Roger Voinson, Orbey
Mandataire: Kirker & Cie S.A., Ingénieurs-Conseils, 1226 Genève - Thônex
1 (siehe Farbteil Heftmitte)
2 (siehe Farbteil Heftmitte)

Cl. 07-01 134 759 28.01.2008
4 design – bocaux
Déposant: Société des Produits Nestlé SA, 1800 Vevey
Designer: David Francis, Paddington; Béatrice Mariotti, Paris
Mandataire: Nestec S.A., 1800 Vevey
1 (siehe Farbteil Heftmitte)
2 (siehe Farbteil Heftmitte)
3 (siehe Farbteil Heftmitte)
4 (siehe Farbteil Heftmitte)

Cl. 07-06 134 761 27.01.2008
2 design – serviette, mouchoir
Déposant: Su-shisou Communication Sàrl, Neuveville 36, 1700 Fribourg
Designer: Jean-Michel Treyvaud, Fribourg; Masumi Treyvaud, Fribourg



01-H



02-L

Cl. 08-06 134 762 21.01.2008
3 Design – Tür- und Fenstergriffe
Hinterleger: Solarlux Aluminium Systeme GmbH, Gewerbepark 9, 49143 Bissendorf, DE
Designer: Amilios Grohmann, Hamburg
Vertreter: Schneider Feldmann AG, Patent- und Markenanwälte, 8022 Zürich
Priorität: EM 21.09.2007



1





2



3

Cl. 09-03 **134 764** 07.12.2007

2 Design – Schachtel

Hinterleger: Barry Callebaut AG, Pfingstweidstrasse 60, 8005 Zürich

Designer: Clery Bruant, Paris

Priorität: EM 08.06.2007

CACAOBARRYHAUTEPATISSERIE-1 (siehe Farbteil Heftmitte)

CACAOBARRYHAUTEPATISSERIE-2 (siehe Farbteil Heftmitte)

Cl. 09-03 **134 765** 18.01.2008

4 design – ornements pour récipients

Déposant: Société des Produits Nestlé SA, 1800 Vevey

Designer: Alessandra Pizzi, Boulogne

Mandataire: Nestec S.A., 1800 Vevey

1 (siehe Farbteil Heftmitte)

2 (siehe Farbteil Heftmitte)

3 (siehe Farbteil Heftmitte)

4 (siehe Farbteil Heftmitte)

Cl. 09-03 **134 766** 24.01.2008

4 Design – Behältnisse für Kosmetik

Hinterleger: Juvena (International) AG, Industriestrasse 8, 8604 Volketswil

Designer: Bernhard Kinzler, Stuttgart



1



2



3

Cl. 09-03 **134 767** 28.01.2008
 1 Design – Verpackung
 Hinterleger: Hauer HBG Dünger AG, Dorfstrasse 12,
 3257 Grossaffoltern
 Designer: Rudolf Hauer, Grossaffoltern



Eimer Balkonpflanzen Nr. 1

Cl. 09-03, 09-05 **134 768** 21.02.2008
 4 design – éléments décoratifs pour emballages
 Déposant: Société des Produits Nestlé SA, 1800 Vevey
 Designer: Enrico Pestalozzi, Vauderens
 Mandataire: Nestec S.A., 1800 Vevey
 1 (siehe Farbteil Heftmitte)
 2 (siehe Farbteil Heftmitte)
 3 (siehe Farbteil Heftmitte)
 4 (siehe Farbteil Heftmitte)



4

Cl. 09-08 **134 769** 08.02.2008
 1 Design – Palettenüberzug
 Hinterleger: Fuchs Design AG, Rotzbergstrasse 7,
 6362 Stansstad
 Designer: Oliver Fuchs, Kriens

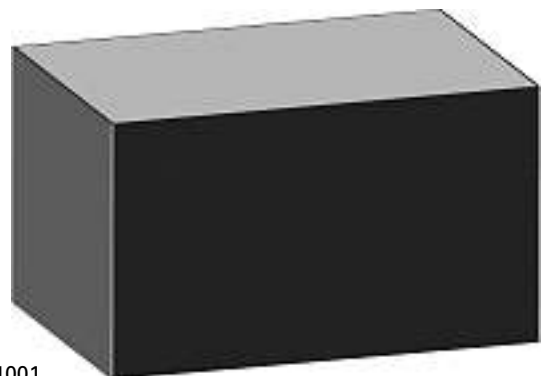

FD1001

Cl. 10-02 134 770 09.01.2008
 6 Design – Armbanduhr
 Hinterleger: Porsche Lizenz- und Handelsgesellschaft mbh & Co. KG, Porschestrasse 1, 74321 Bietigheim-Bissingen, DE
 Designer: Vjekoslav Miloradovic, Biel; Marcus Kuchler, München
 Vertreter: Isler & Pedrazzini AG, 8027 Zürich
 Priorität: DE, 14.07.2007, DE, 14.07.2007, DE, 14.07.2007; DE, 14.07.2007, DE, 14.07.2007, DE, 14.07.2007
 1 (siehe Farbteil Heftmitte)
 2 (siehe Farbteil Heftmitte)
 3 (siehe Farbteil Heftmitte)
 4 (siehe Farbteil Heftmitte)
 5 (siehe Farbteil Heftmitte)
 6 (siehe Farbteil Heftmitte)

Cl. 10-04 134 771 25.01.2008
 1 Design – Messgerät
 Hinterleger: Max Stricker, Alte Wildernstrasse 17, 9556 Zezikon



DZW08

Cl. 10-07 134 772 23.01.2008
 3 Design – Uhr, Uhrenteile
 Hinterleger: FELDO LUXURY SL, Cruz 22, 02500 Tobarra (Albacete), ES
 Designer: Hilmar Vielhaber, Meschede
 Vertreter: Witrag Management Consultants AG, 6302 Zug

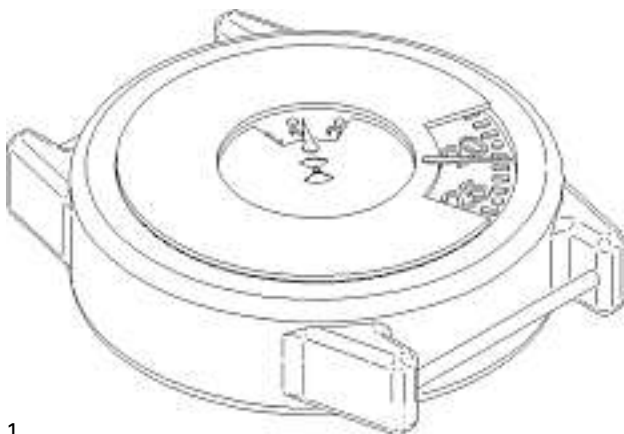

1

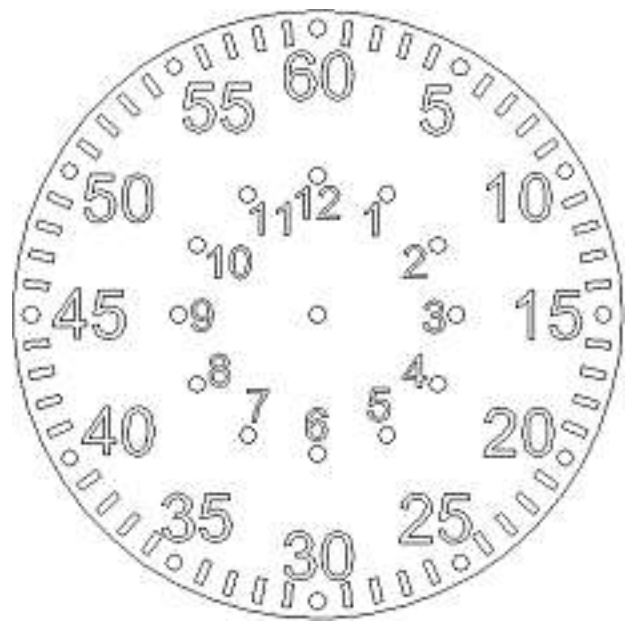

2

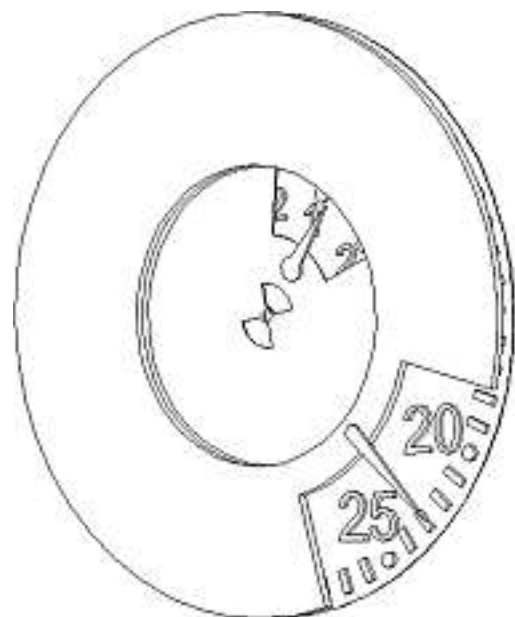
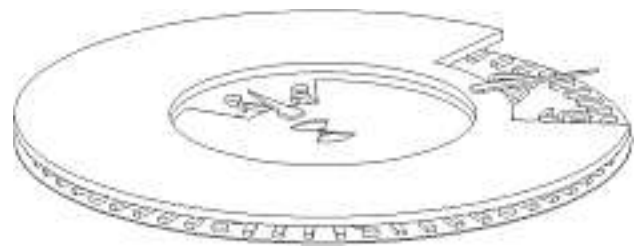

3

Cl. 11-01 **134 774** 29.01.2008
 1 Design – Schmuckstein
 Hinterleger: Swarovski Aktiengesellschaft, Dröschstrasse 15,
 9495 Triesen, LI
 Designer: Christian Loinger, Kramsach
 Vertreter: Isler & Pedrazzini AG, 8027 Zürich
 Priorität: EM 16.10.2007

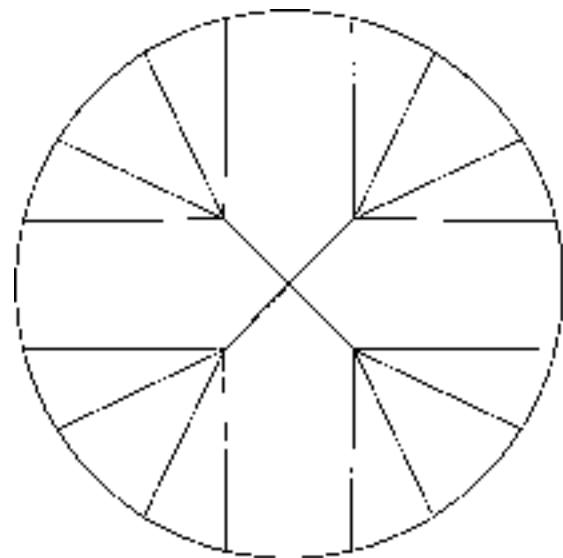
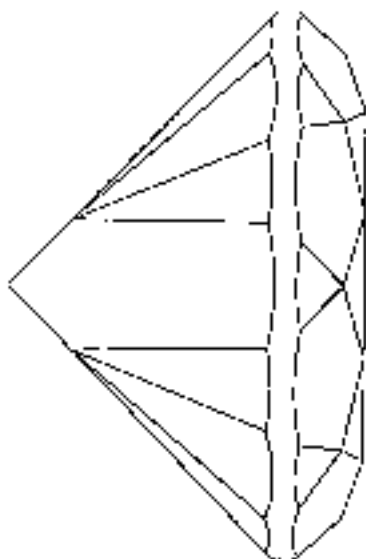
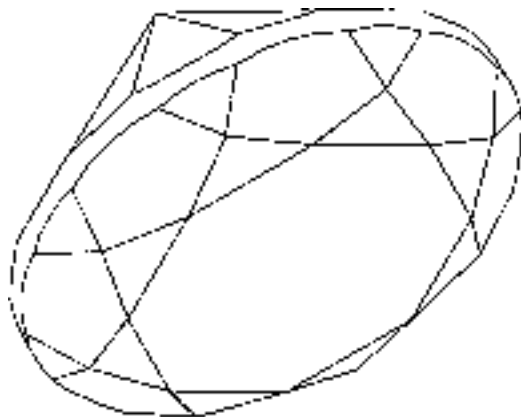
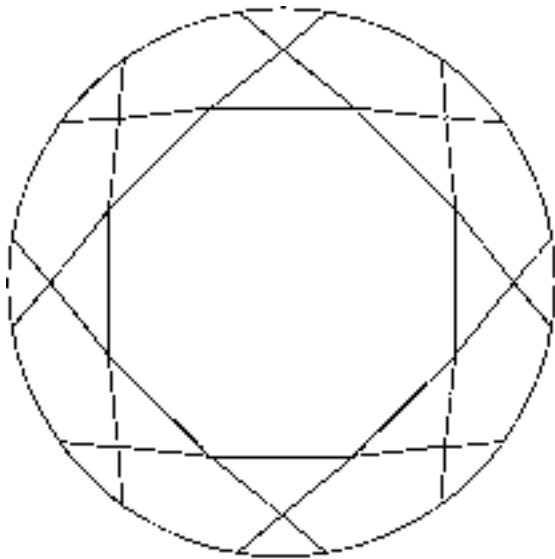

M13432

Cl. 11-02 **134 775** 14.01.2008
 1 Design – Ziergegenstand
 Hinterleger: Silvia Leiser, Bielstrasse 19, 3270 Aarberg
 Designer: Anita Silvia Rita Leiser, Biel; Sebastian Schütz,
 Wahlsburg-Lippoldsberg
 Zwirbel4 (siehe Farbteil Heftmitte)

Cl. 14-03 **134 776** 08.01.2008
 1 Design – Navigationssysteme
 Hinterleger: IPublish Ganske Interactive Publishing GmbH,
 Berg-am-Laim-Strasse 47, 81673 München, DE
 Designer: James Whittaker, Stuttgart
 Vertreter: Meyer Lustenberger, 8032 Zürich
 Priorität: DE 13.07.2007
 1 (siehe Farbteil Heftmitte)

Cl. 14-99 **134 777** 11.02.2008
 3 Design – Bedien-/Anzeige-panel
 Hinterleger: Inventio AG, Postfach, 6052 Hergiswil NW
 Designer: Dennys Taiana, Losone; Bernhard Gerstenkorn,
 Ebikon
 ID37.1CH (siehe Farbteil Heftmitte)
 ID37.2CH (siehe Farbteil Heftmitte)
 ID37.3CH (siehe Farbteil Heftmitte)

Cl. 19-06 **134 778** 14.01.2008
 2 Design – Kugelschreiber
 Hinterleger: Klio-Eterna Schreibgeräte GmbH & Co. KG,
 Glashüttenweg 7, Wolfach, DE
 Designer: Alexander Slemp, Wolfach
 Vertreter: Hans Rudolf Gachnang, Patentanwalt,
 8501 Frauenfeld
 Priorität: EM 24.08.2007
 1 (siehe Farbteil Heftmitte)
 2 (siehe Farbteil Heftmitte)

Cl. 19-08 **134 779** 27.12.2007
 2 Design – Graphische Bildzeichen
 Hinterleger: Mars Schweiz AG, Baarermattstrasse 6,
 6340 Baar
 Designer: Matthew Walker, Prahran
 Vertreter: A.W. Metz & Co. AG, 8024 Zürich
 1 (siehe Farbteil Heftmitte)
 2 (siehe Farbteil Heftmitte)

Cl. 19-08 **134 780** 15.01.2008
 21 design – imprimés
 Déposant: Société des Produits Nestlé SA, 1800 Vevey
 Designer: Jeff Witek, Twickenham; Leigh Fowler, Teddington;
 Wayne Sparrowhawk, Walton-on-Thames; Neil Monk,
 Banstead; Mark Alton, Wallington

Mandataire: Nestec S.A., 1800 Vevey

- 1 (siehe Farbteil Heftmitte)
- 2 (siehe Farbteil Heftmitte)
- 3 (siehe Farbteil Heftmitte)
- 4 (siehe Farbteil Heftmitte)
- 5 (siehe Farbteil Heftmitte)
- 6 (siehe Farbteil Heftmitte)
- 7 (siehe Farbteil Heftmitte)
- 8 (siehe Farbteil Heftmitte)
- 9 (siehe Farbteil Heftmitte)
- 10 (siehe Farbteil Heftmitte)
- 11 (siehe Farbteil Heftmitte)
- 12 (siehe Farbteil Heftmitte)
- 13 (siehe Farbteil Heftmitte)
- 14 (siehe Farbteil Heftmitte)
- 15 (siehe Farbteil Heftmitte)
- 16 (siehe Farbteil Heftmitte)
- 17 (siehe Farbteil Heftmitte)
- 18 (siehe Farbteil Heftmitte)
- 19 (siehe Farbteil Heftmitte)
- 20 (siehe Farbteil Heftmitte)
- 21 (siehe Farbteil Heftmitte)

Cl. 19-08 **134 781** 29.01.2008

4 design – imprimés

Déposant: Société des Produits Nestlé SA, 1800 Vevey

Designer: Jérôme Lanoy, Boulogne

Mandataire: Nestec S.A., 1800 Vevey

- 1 (siehe Farbteil Heftmitte)
- 2 (siehe Farbteil Heftmitte)
- 3 (siehe Farbteil Heftmitte)
- 4 (siehe Farbteil Heftmitte)

Cl. 19-08 **134 782** 29.01.2008

4 design – imprimés

Déposant: Société des Produits Nestlé SA, 1800 Vevey

Designer: Jérôme Lanoy, Boulogne

Mandataire: Nestec S.A., 1800 Vevey

- 1 (siehe Farbteil Heftmitte)
- 2 (siehe Farbteil Heftmitte)
- 3 (siehe Farbteil Heftmitte)
- 4 (siehe Farbteil Heftmitte)

Cl. 20-03 **134 783** 27.01.2008

3 Design – Terminal

Hinterleger: A-Design AG, Baselstrasse 77, 4500 Solothurn

Designer: Christa Angehrn Reichenbach, Solothurn



1

2



3

Cl. 21-01 **134 784** 16.01.2008

1 design – peluche (jouet)

Déposant: RODA SOCIETE ANONYME, Zone Artisanale d'Hachimette, 68650 Lapoutroie, FR

Designer: Roger Voinson, Orbey

Mandataire: Kirker & Cie S.A., Ingénieurs-Conseils, 1226 Genève - Thônex

- 3 (siehe Farbteil Heftmitte)

Cl. 21-02 **134 785** 26.01.2008

1 Design – Sportgerät

Hinterleger: Marc Schertenleib, Chalet Berghaus, 3718 Kandersteg



homeslackline

Cl. 23-02 **134 786** 11.12.2007
 5 Design – Sanitärapparate-Oberflächen
 Hinterleger: Bagno Sasso AG, Schulstrasse 76,
 7302 Landquart
 Designer: Tilo Gnausch, Zürich
 1 (siehe Farbteil Heftmitte)
 2 (siehe Farbteil Heftmitte)
 3 (siehe Farbteil Heftmitte)
 4 (siehe Farbteil Heftmitte)
 5 (siehe Farbteil Heftmitte)

Cl. 23-02 **134 787** 28.01.2008
 3 Design – Sanitärartikel und Teile dazu
 Hinterleger: Lillie Eberhard, Fritz Gottlieb Pfisterweg 73,
 8703 Erlenbach ZH; Yvonne Eberhard, Fritz Gottlieb
 Pfisterweg 73, 8703 Erlenbach ZH
 Vertreter: Lillie Eberhard, 8703 Erlenbach ZH

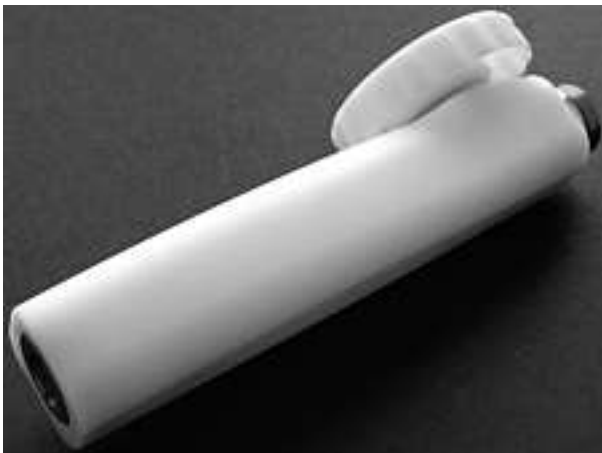

MT



OT



Zubehör

Cl. 23-02 **134 788** 06.02.2008

28 Design – Saunazubehör und -ausstattung
 Hinterleger: Klafs GmbH & Co. KG, Erich-Klafs-Strasse 1-3,
 74523 Schwäbisch Hall, DE
 Designer: Martin Schultheiss, Schwäbisch Gmünd
 Vertreter: reuteler & cie S.A., 1260 Nyon

- Priorität: EM 19.09.2007
 1 (siehe Farbteil Heftmitte)
 2 (siehe Farbteil Heftmitte)
 3 (siehe Farbteil Heftmitte)
 4 (siehe Farbteil Heftmitte)
 5 (siehe Farbteil Heftmitte)
 6 (siehe Farbteil Heftmitte)
 7 (siehe Farbteil Heftmitte)
 8 (siehe Farbteil Heftmitte)
 9 (siehe Farbteil Heftmitte)
 10 (siehe Farbteil Heftmitte)
 11 (siehe Farbteil Heftmitte)
 12 (siehe Farbteil Heftmitte)
 13 (siehe Farbteil Heftmitte)
 14 (siehe Farbteil Heftmitte)
 15 (siehe Farbteil Heftmitte)
 16 (siehe Farbteil Heftmitte)
 17 (siehe Farbteil Heftmitte)
 18 (siehe Farbteil Heftmitte)
 19 (siehe Farbteil Heftmitte)
 20 (siehe Farbteil Heftmitte)
 21 (siehe Farbteil Heftmitte)
 22 (siehe Farbteil Heftmitte)
 23 (siehe Farbteil Heftmitte)
 24 (siehe Farbteil Heftmitte)
 25 (siehe Farbteil Heftmitte)
 26 (siehe Farbteil Heftmitte)
 27 (siehe Farbteil Heftmitte)
 28 (siehe Farbteil Heftmitte)

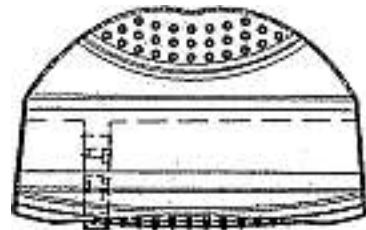
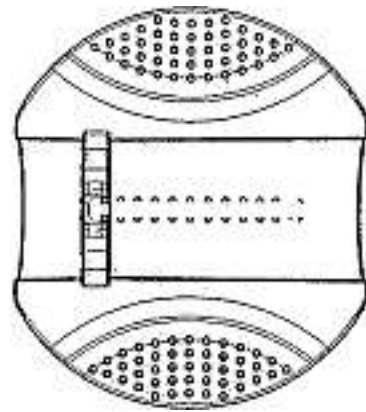

Cl. 23-04 **134 789** 08.02.2008

1 Design – Ventilatorenabdeckung
 Hinterleger: Helios Ventilatoren GmbH & Co., Lupfenstrasse 8,
 78056 Villingen-Schwenningen, DE
 Designer: Bernhard Schwanitz, Strasslach; Stefan
 Thalhammer, Strasslach
 Vertreter: Isler & Pedrazzini AG, 8027 Zürich
 M13469 (siehe Farbteil Heftmitte)

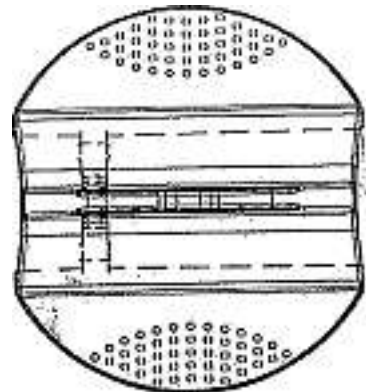

Cl. 24-03 **134 790** 21.01.2008

2 Design – Zahnimplantat-Halter
 Hinterleger: inpac Medizintechnik GmbH, Gewerbestrasse 34,
 75217 Birkenfeld, DE
 Designer: Ralph Hermann, Karlsruhe; Heiko Kaczorowski,
 Bad Liebenzell
 Vertreter: Troesch Scheidegger Werner AG, Patent- und
 Markenanwälte, 8126 Zumikon
 Priorität: EM 25.07.2007

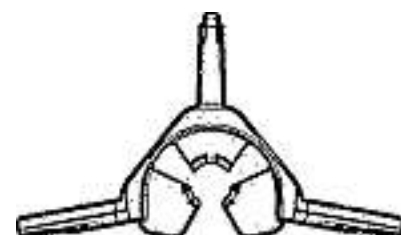
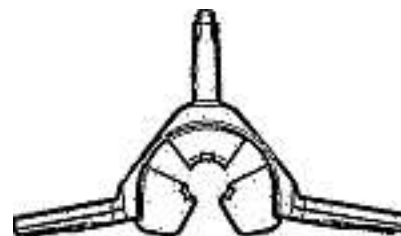

D300231-1



D300231-2

Cl. 24-04 **134 791** 14.01.2008
 1 Design – Handgelenkorthese
 Hinterleger: Bauerfeind AG, Triebeser Strasse 16,
 07937 Zeulenroda, DE
 Designer: Hans B. Bauerfeind, Zeulenroda; Holger Reinhardt,
 Kempen
 Vertreter: A. Braun, Braun, Héritier, Eschmann AG,
 Patentanwälte, 4051 Basel
 Priorität: EM 16.07.2007
 1 (siehe Farbteil Heftmitte)

Cl. 25-02 **134 792** 12.02.2008
 1 Design – Bodenbelag
 Hinterleger: Firth-Furniture, Burgstrasse 2, 3600 Thun
 Designer: Andrea Sonnenmoser, Küsnacht; Sean Firth,
 Küsnacht



Slattingboden

Verlängerungen Prolongations Prolongazioni

116 744 Cl. 24-04 1 Design

120 407 Cl. 08-07 1 design

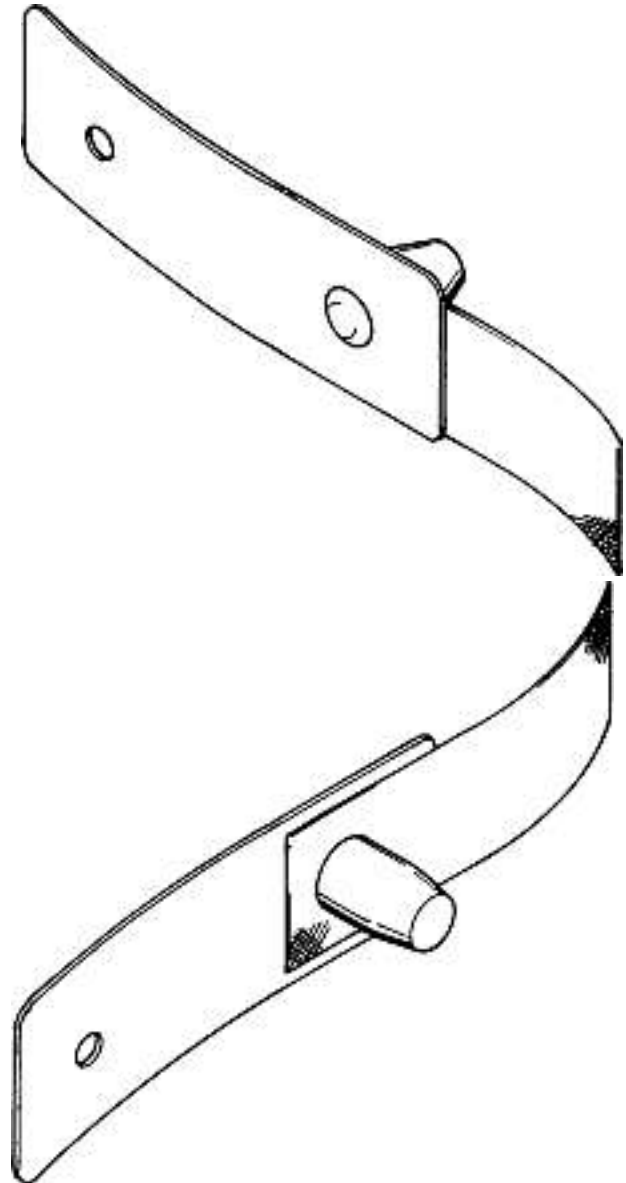

1

120 453 Cl. 10-02 1 design

120 489 Cl. 07-99 2 Design



0593-01



0593-02

120 523 Cl. 13-03 2 Design
1 (siehe Farbteil Heftmitte)
2 (siehe Farbteil Heftmitte)

120 541 Cl. 06-04 1 Design





1

120 695 Cl. 08-03 1 Design

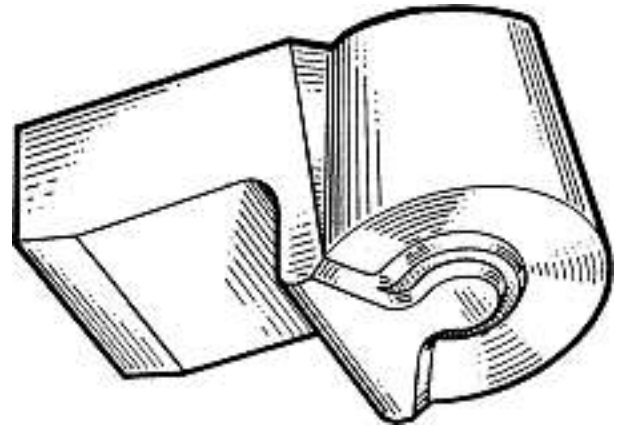
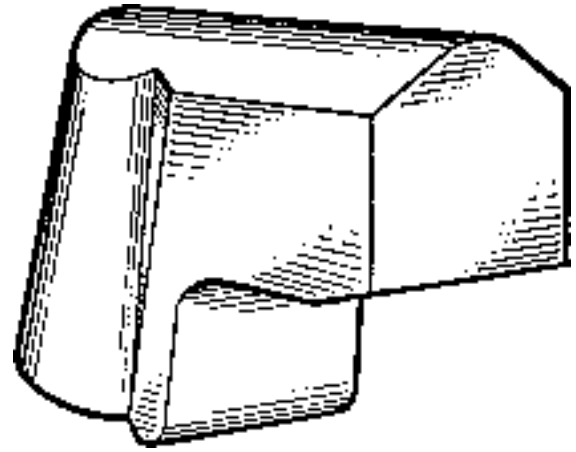
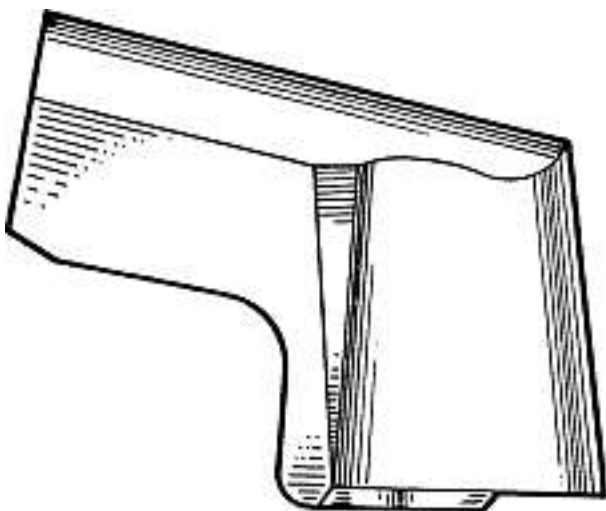

D 315 CH

124 507	Cl.	21-01	1 Design
124 534	Cl.	13-01	1 Design
124 535	Cl.	13-01	1 Design
124 846	Cl.	07-05	4 Design
124 880	Cl.	06-07	4 Design
124 887	Cl.	07-04	1 Design
124 898	Cl.	12-05	1 design
124 948	Cl.	03-01	1 Design
125 084	Cl.	20-02	1 design
125 128	Cl.	21-02	1 Design
125 183	Cl.	06-03	12 Design
129 089	Cl.	02-02	2 Design
129 444	Cl.	99-00	1 Design
129 494	Cl.	06-01	2 Design
129 496	Cl.	06-01	4 Design
129 499	Cl.	06-05	1 Design
129 500	Cl.	06-06	1 design
129 506	Cl.	09-01	1 Design
129 515	Cl.	15-99	6 Design
129 523	Cl.	24-04	2 design
129 531	Cl.	01-01	1 Design
129 538	Cl.	05-05	4 Design
129 540	Cl.	06-01	2 design
129 609	Cl.	09-07	1 Design
129 638	Cl.	24-02	3 Design
129 691	Cl.	09-03	4 Design
129 702	Cl.	12-16	7 Design
129 714	Cl.	26-06	3 Design
129 727	Cl.	06-01	1 Design
129 739	Cl.	09-07	1 Design
129 741	Cl.	09-09	1 Design
129 752	Cl.	25-02	1 Design
129 753	Cl.	25-03	2 Design
129 754	Cl.	25-03	3 Design
129 755	Cl.	26-05	1 Design
129 806	Cl.	24-99	2 Design

Mutationen
Modifications
Modificazioni

129 214

Neuer Vertreter

Vertreter: MICHELI & CIE SA, 1226 Thônex

130 344**134 132**

Namensänderung

Hinterleger: HMS Easy Stretch GmbH, Salzstrasse 190,
74076 Heilbronn, DE

Löschungen
Radiations
Radiazioni

116 075	Cl.	02-07	1 Design
116 122	Cl.	09-01	1 Design
116 139	Cl.	18-99	1 Design
119 948	Cl.	14-99	1 Design
119 953	Cl.	25-01	11 Design
119 960	Cl.	06-03	2 Design
124 385	Cl.	12-11	2 Design
124 411	Cl.	06-03	1 Design
124 438	Cl.	23-02	2 Design
124 487	Cl.	07-01	1 Design
124 488	Cl.	07-01	1 Design
124 571	Cl.	13-02	1 Design
124 581	Cl.	27-05	1 Design
128 992	Cl.	03-01	1 Design
129 011	Cl.	14-02	1 design
129 019	Cl.	20-03	1 Design
129 020	Cl.	20-03	3 Design
129 021	Cl.	21-01	3 Design
129 022	Cl.	26-05	1 Design
129 023	Cl.	27-05	3 design
129 024	Cl.	27-05	2 design
129 029	Cl.	08-05	1 Design
129 030	Cl.	08-05	1 Design
129 034	Cl.	13-03	1 design
129 037	Cl.	19-08	2 Design
129 038	Cl.	20-03	1 Design
129 041	Cl.	26-05	1 Design
129 046	Cl.	09-01	12 Design
129 077	Cl.	12-14	12 Design
129 133	Cl.	06-09	4 Design
129 164	Cl.	23-01	1 Design
129 357	Cl.	08-99	1 design
129 372	Cl.	19-06	2 design
129 738	Cl.	09-03	1 Design

Cl. 01-01

134 744

24.01.2008

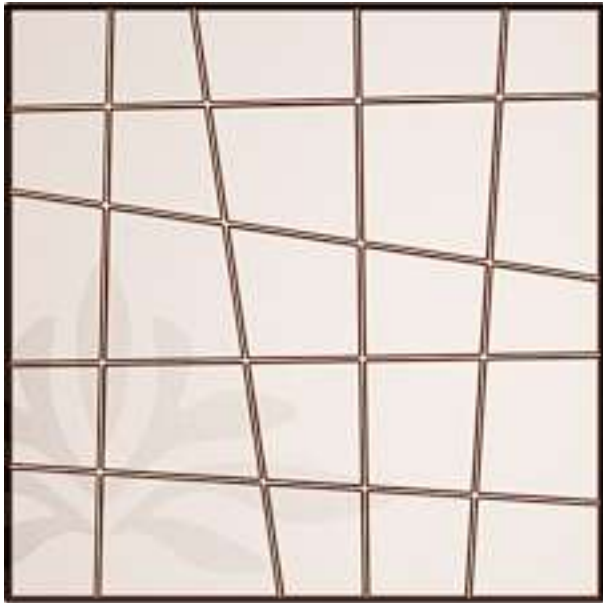

158780/010001

Cl. 03-01

134 746

16.01.2008



4



5



6

Cl. 03-03

134 749

12.09.2007





M13415

Cl. 06-01

134 751

11.01.2008





D300229



Cl. 06-01

134 753

21.01.2008



1







3



4





6



5



7



8





9



10



Cl. 06-09

134 758

16.01.2008



1



2

Cl. 07-01

134 759

28.01.2008



1



2



3



4

Cl. 09-03

134 764

07.12.2007



CACAOBARRYHAUTEPATISSERIE-2



CACAOBARRYHAUTEPATISSERIE-1

Cl. 09-03

134 765

18.01.2008



1



2



3



4

Cl. 09-03, 09-05

134 768

21.02.2008



1



2



3

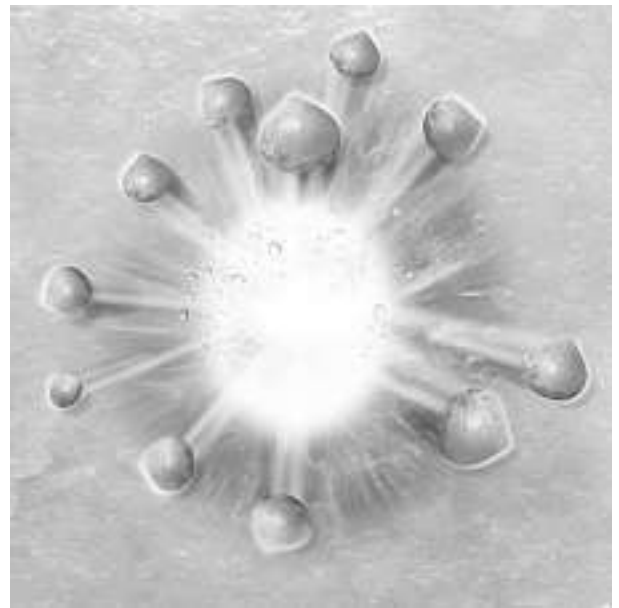

4

Cl. 10-02

134 770

09.01.2008



1











5



6

Cl. 11-02

134 775

14.01.2008



Zwirbel4



Cl. 14-03

134 776

08.01.2008





1

Cl. 14-99

134 777

11.02.2008



ID37.2CH



ID37.3CH

Cl. 19-06

134 778

14.01.2008



ID37.1CH



1

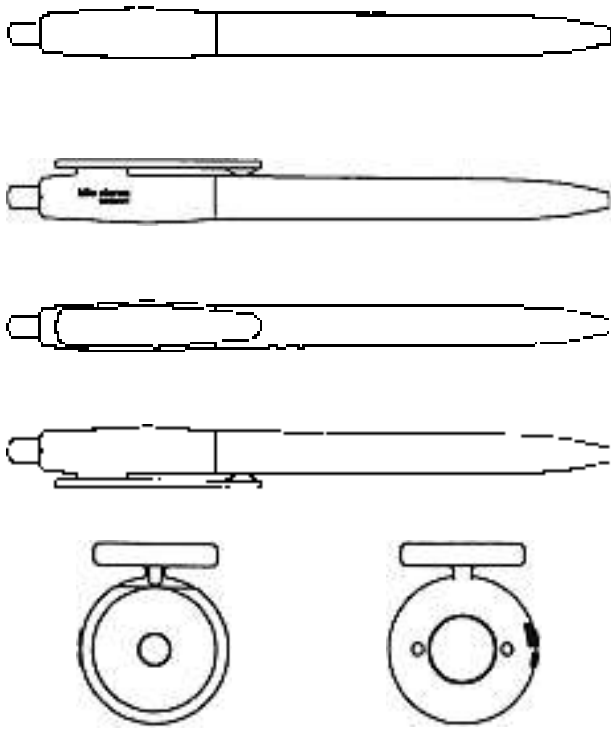

2

Cl. 19-08

134 779

27.12.2007

2



3



1



2

Cl. 19-08

134 780

15.01.2008

4



1



5





6



10



7



11

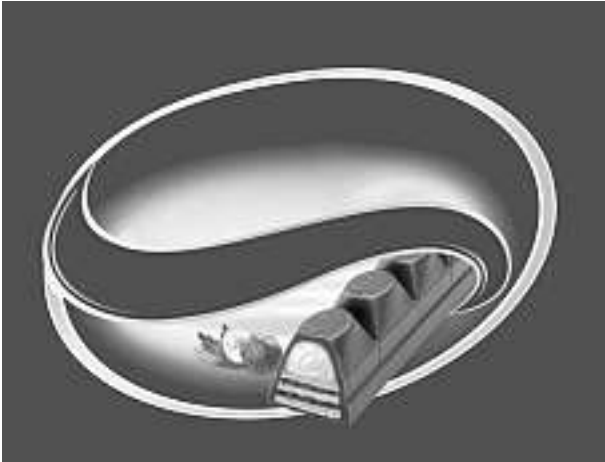

8



12



13



9

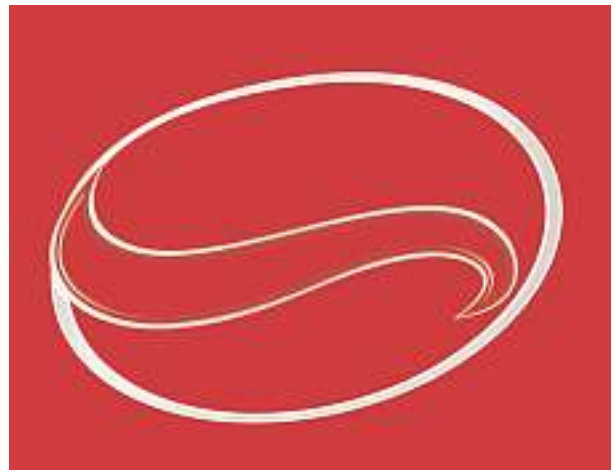

14



15



19



16



17



20



18



21

Cl. 19-08

134 781

29.01.2008



1

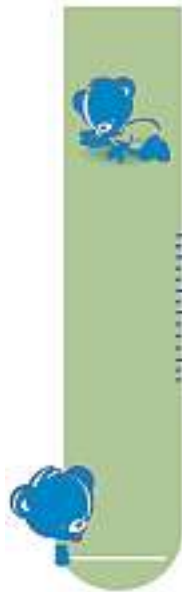

2



3



4



2



3

Cl. 19-08

134 782

29.01.2008



1



4

Cl. 21-01

134 784

16.01.2008



3

Cl. 23-02

134 786

11.12.2007



1



3



4



5

Cl. 23-02

134 788

06.02.2008



2



1



2



5



3



6



4



7

8



9



10



11





12



14



13



15





16



17



18



19



20



21



22



23



24



25

26



27



28



Cl. 23-04

134 789

08.02.2008



M13469



Cl. 24-04

134 791

14.01.2008

120 523

Cl.

13-03

2 Design



1

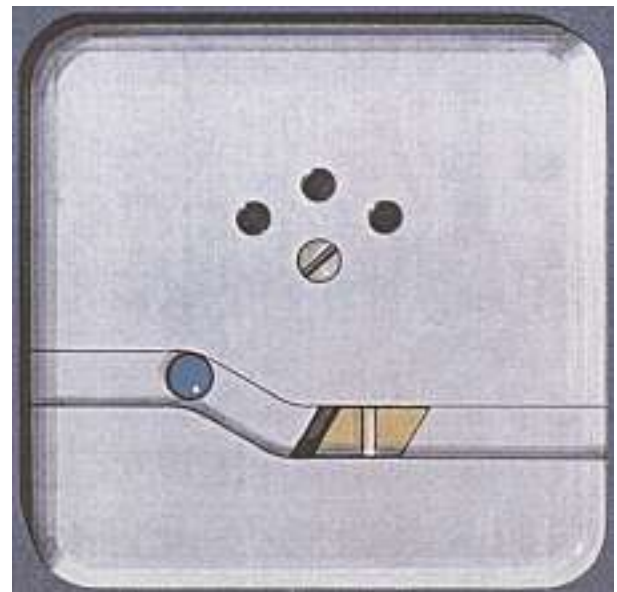

1



2