

Nationale Hinterlegungen

In der folgenden Liste werden die beim Eidgenössischen Institut für Geistiges Eigentum hinterlegten Designs publiziert. Dabei sind der Reihe nach angegeben:

- internationale Klassenangaben
- Hinterlegungsnummer
- Hinterlegungsdatum
- Allenfalls Aufschub der Veröffentlichung
- Anzahl der hinterlegten Designs
- Bezeichnung
- Name und Wohnsitz des Hinterlegers oder der Hinterlegerin
- gegebenenfalls Name und Wohnsitz des Designers oder der Designerin
- Name und Geschäftssitz des allfälligen Vertreters oder der Vertreterin
- gegebenenfalls Prioritätsangaben
- gegebenenfalls Beschreibungstext
- Ordnungsnummer
- Reproduktion des Designs

Internationale Hinterlegungen

Die bei der Weltorganisation für geistiges Eigentum in Genf hinterlegten Muster und Modelle mit Benennung Schweiz geniessen den gleichen Schutz wie national hinterlegte Designs. Sie werden jeweils im Blatt «Bulletin des dessins et modèles internationaux» veröffentlicht. Dieses Publikationsorgan ist deshalb für eine vollständige Recherche unbedingt beizuziehen.

Topographien

Angaben über die vom Eidgenössischen Institut für Geistiges Eigentum eingetragenen Topographien von Halbleitererzeugnissen werden in folgender Anordnung aufgeführt:

- Eintragsnummer
- Anmeldedatum
- Bezeichnung
- Name und Wohnsitz des Anmelders oder der Anmelderin
- gegebenenfalls Name und Wohnsitz des Herstellers oder der Herstellerin
- Name und Geschäftssitz des oder der allfälligen Bevollmächtigten
- Datum und Ort einer allfälligen ersten geschäftlichen Verbreitung der Topographie

Dépôts nationaux

Les designs déposés à l'Institut Fédéral de la Propriété Intellectuelle sont publiés dans la liste qui suit. Les indications y relatives sont mentionnées dans cet ordre:

- indications des classes internationales
- numéro de dépôt
- date de dépôt
- le cas échéant, ajournement de la publication
- nombre des designs déposés
- désignation
- nom et domicile du/de la déposant/e
- le cas échéant, nom et domicile du/de la designer
- nom et domicile de l'éventuel/le mandataire
- le cas échéant, indication de priorité
- le cas échéant, description du design
- numéro attribué à chaque design
- reproduction du design

Dépôts internationaux

Les dessins et modèles déposés à l'Organisation Mondiale de la Propriété Intellectuelle à Genève qui désignent la Suisse jouissent de la même protection que les dépôts nationaux. Ils sont chaque fois publiés dans la feuille «Bulletin des dessins et modèles internationaux». Pour une recherche complète, il est indispensable de consulter ledit organe de publication.

Topographies

Les indications concernant les topographies des produits semi-conducteurs, enregistrées par l'Institut Fédéral de la Propriété Intellectuelle, sont énumérées dans l'ordre suivant:

- numéro d'enregistrement
- date de dépôt
- désignation
- nom et domicile du/de la déposant/e
- le cas échéant, nom et domicile du/de la producteur/trice
- nom et domicile de l'éventuel/le mandataire
- date et lieu d'une éventuelle première mise en circulation de la topographie

Depositi nazionali

Nella lista seguente vengono pubblicati i design depositati presso l'Istituto Federale della Proprietà Intellettuale. Sono menzionati nel seguente ordine:

- indicazioni delle classi internazionali
- numero di deposito
- data del deposito
- se del caso, indicazione che la pubblicazione è stata differita
- numero dei design depositati
- designazione
- nome e domicilio del depositante
- se del caso, nome e domicilio del designer
- nome e sede di un eventuale mandataro
- se del caso, indicazioni di priorità
- se del caso, descrizione del design
- numero d'ordine
- riproduzione del design

Depositi internazionali

I disegni e modelli depositati presso l'Organizzazione Mondiale della Proprietà Intellettuale a Ginevra con denominazione Svizzera godono della medesima protezione del deposito nazionale. Essi vengono pubblicati ogni volta nel foglio «Bulletin des dessins et modèles internationaux». Quest'organo di pubblicazione è da consultare se si vuole effettuare una ricerca completa.

Topografie

Le indicazioni concernenti le topografie di prodotti a semiconduttori depositati presso l'Istituto Federale della Proprietà Intellettuale sono menzionate nell'ordine seguente:

- numero di registrazione
- data del deposito
- designazione
- nome e domicilio del/la richiedente
- se del caso, nome e domicilio del/la produttore/trice
- nome e sede di un eventuale mandataro
- data e luogo di un'eventuale prima messa in circolazione della topografia

Hinterlegungen
Dépôts
Depositi

Cl. 10-07 132 666 22.03.2006
1 design – montre
Déposant: MB&F SA, Chemin de Grange-Canal 35,
1223 Coligny
Designer: Eric Giroud, Genève
Mandataire: Inteltech SA, 2001 Neuchâtel
Fin de la période ajournement de la publication

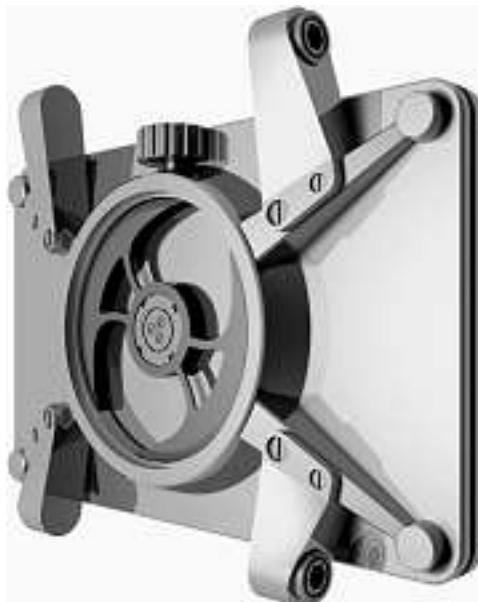

1

Cl. 10-07 133 241 30.10.2006
1 design – montre
Déposant: MB&F SA, Chemin de Grange-Canal 35,
1223 Coligny
Designer: Eric Giroud, Genève
Mandataire: Inteltech SA, 2001 Neuchâtel
Fin de la période ajournement de la publication



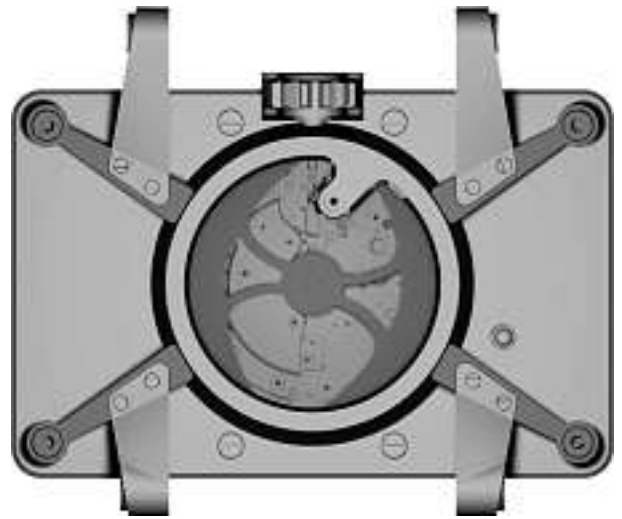
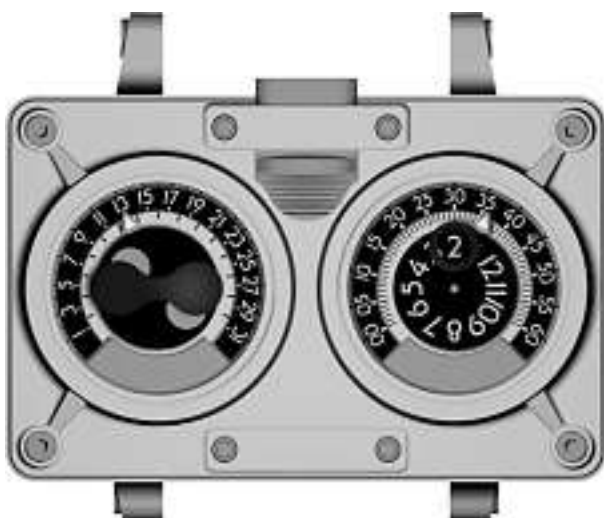

1

Cl. 10-02 **134 113** 02.05.2007

3 design – montres

Déposant: First Watch, 138 Bigaa, Cabuyao, Laguna, PH

Designer: David Neilan Brady, Bar Beach; Manuel Spode, Le Locle

Mandataire: MICHELI & CIE SA, 1226 Thônex

Fin de la période ajournement de la publication





14810 A





14810 B



14810 C

Cl. 26-02 **134 259** 09.08.2007

1 Design – Stabtaschenlampe

Hinterleger: Rudolf Götschi, Lüsselweg 13, 4225 Brislach

Ende aufgeschobene Publikation



Mückenfänger rund

Cl. 15-07 **134 294** 28.09.2007

2 design – machines et appareils de réfrigération

Déposant: Société des Produits Nestlé SA, 1800 Vevey

Designer: Frank Rousselin, Voiron

Mandataire: Nestec S.A., 1800 Vevey

Fin de la période ajournement de la publication

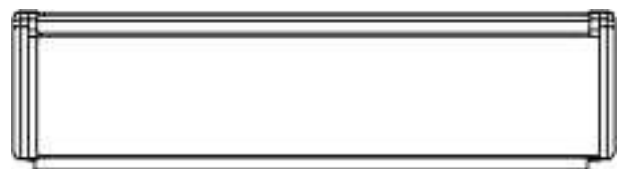

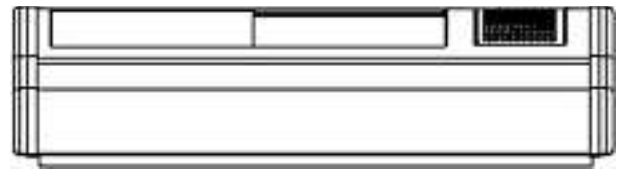
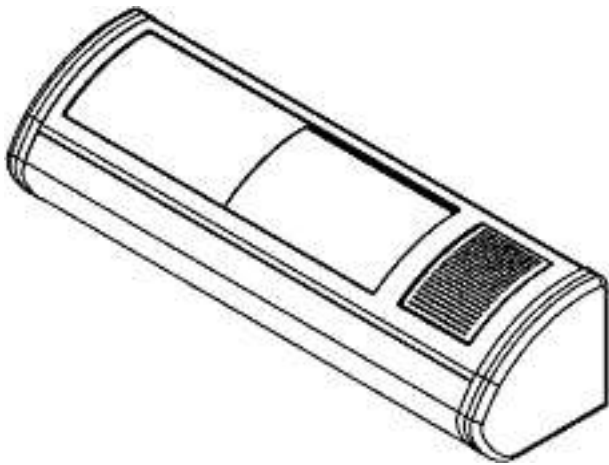

FL 68082/1

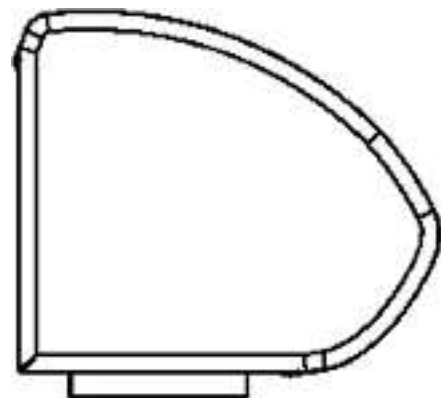
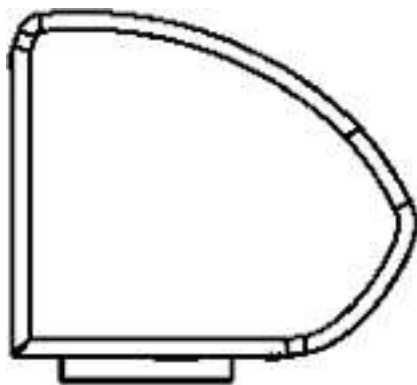
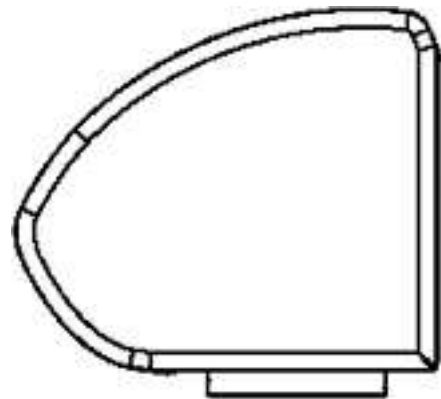
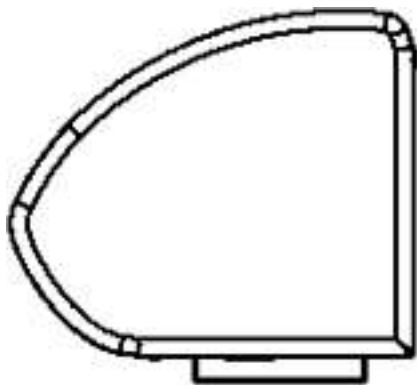
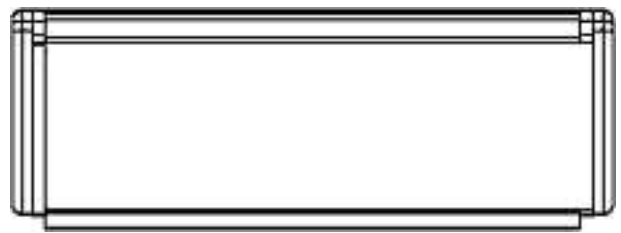
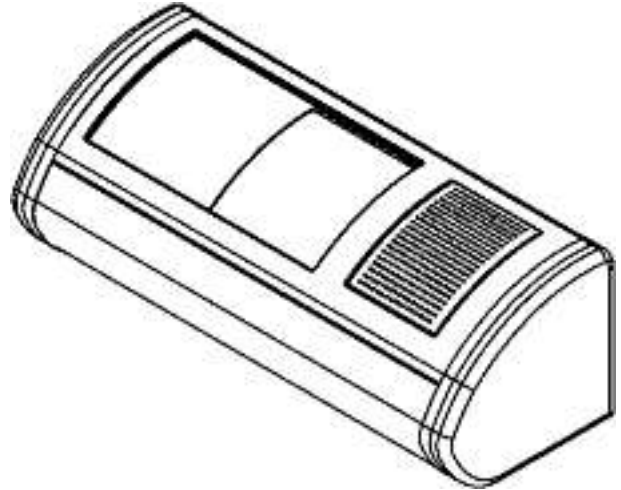
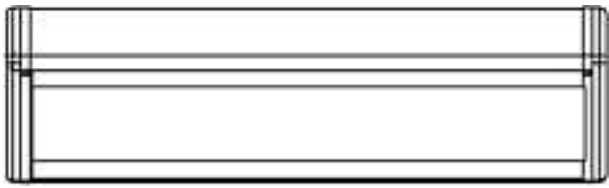

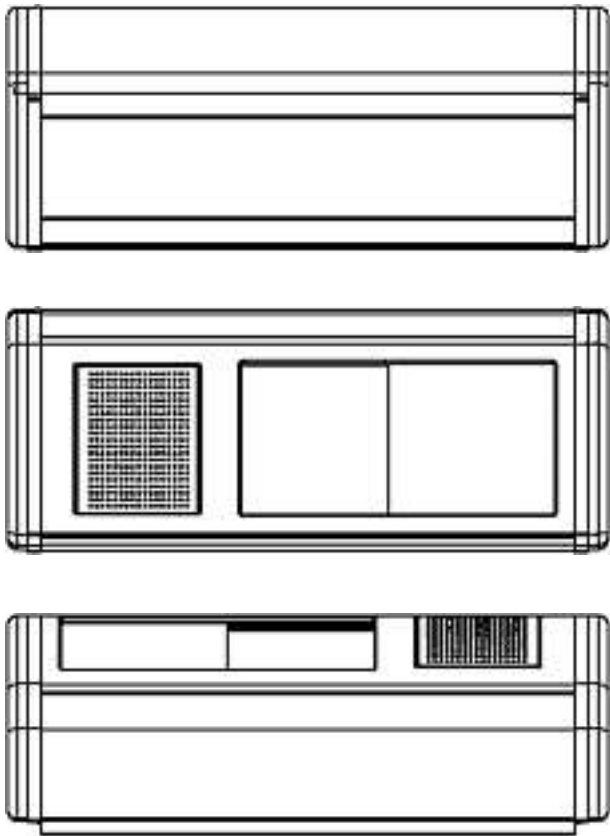

FL 68082/2

Cl. 10-07 **134 411** 10.10.2007
 1 design – boîte de montre
 Déposant: Badollet International SA, avenue d'Aire 40,
 1203 Genève
 Designer: Aldo Magada, Saint-Prex
 Mandataire: Inteltech SA, 2001 Neuchâtel
 Fin de la période ajournement de la publication

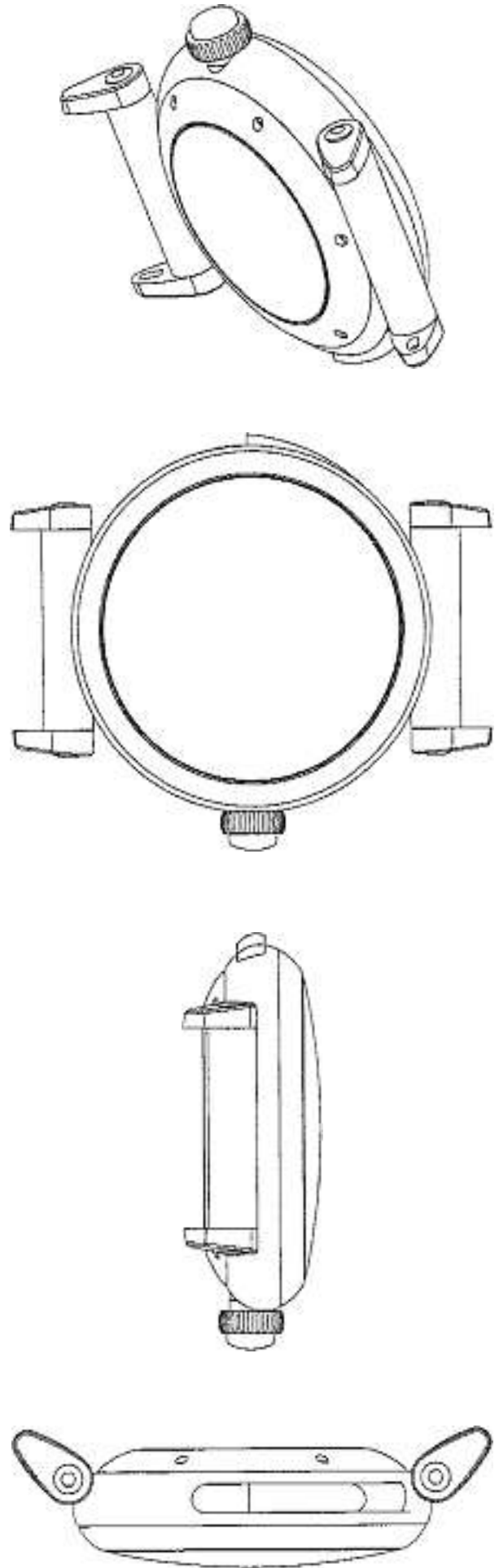

150750/010001

Cl. 10-07 134 412 11.10.2007
 1 design – boîte de montre
 Déposant: Badollet International SA, avenue d'Aire 40,
 1203 Genève
 Designer: Aldo Magada, Saint-Prex
 Mandataire: Inteltech SA, 2001 Neuchâtel
 Fin de la période ajournement de la publication



150750/010002

Cl. 10-02 134 590 12.12.2007
 5 design – montres-bracelets
 Déposant: Bédât & Co SA, 45, rue Agasse, 1208 Genève
 Designer: Dino Modolo, La Chaux-de-Fonds
 Mandataire: Inteltech SA, 2001 Neuchâtel
 Fin de la période ajournement de la publication





1



2



3





4



5



Cl. 28-01 134 668 21.12.2007
 1 Design – Tablette
 Hinterleger: Mepha AG, Dornacherstrasse 114, Postfach 445,
 4147 Aesch BL
 Designer: Marco Spitz, Binzen
 Vertreter: Braunpat Braun Eder AG, 4054 Basel
 Ende aufgeschobene Publikation

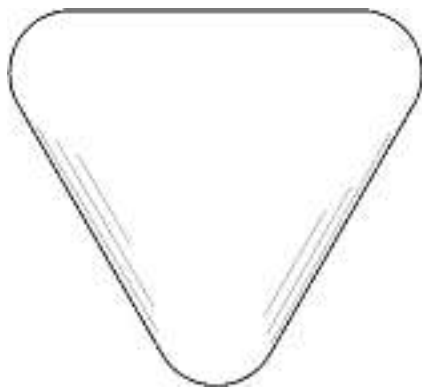
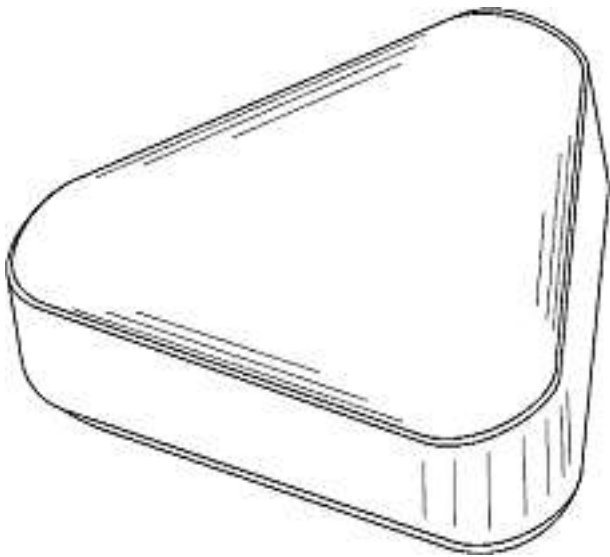

1



1



2



3

Cl. 06-01 134 795 16.01.2008
 23 Design – Polstermöbel
 Hinterleger: Bise.com GmbH, Europa Center 13. OG,
 10789 Berlin, DE
 Designer: Toshiyuki Kita, Osaka
 Vertreter: Wartmann & Merker, 8022 Zürich
 Priorität: EM, 28.11.2007







23



Cl. 06-01 **134 796** 28.01.2008
 5 Design – Sitzmöbel
 Hinterleger: Wolfgang Hints, Paracelsusgasse 8/1/9,
 1030 Wien, AT
 Vertreter: Isler & Pedrazzini AG, 8027 Zürich
 Priorität: EM, 03.10.2007; EM, 03.10.2007; EM, 03.10.2007;
 EM, 03.10.2007; EM, 03.10.2007

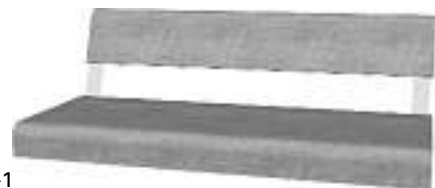

M13462-1



M13462-2



M13462-3



M13462-4



M13462-5

Cl. 06-01 134 797 10.02.2008
1 Design – Stuhl
Hinterleger: Vitra Patente AG, Klünenfeldstrasse 22,
4132 Muttenz
Designer: Antonio Citterio, Mailand
Vertreter: AXON Patent GmbH, 4147 Aesch





1



Cl. 06-01, 06-02 **134 798** 13.02.2008
 5 Design – Sessel, Sofa, Liege, Bett, Sofa/Liege
 Hinterleger: Bise.com GmbH, Europa Center 13. OG,
 10789 Berlin, DE
 Designer: Giuseppe Vigano, Lissone
 Vertreter: Wartmann & Merker, 8022 Zürich





Ottovolante Sessel





Ottovolante Sofa

Ottovolante Bett





Ottovolante Liege



Ottovolante Sofa/Liege Kombination



Cl. 06-01 134 799 15.02.2008
1 Design – Bank
Hinterleger: BURRI public elements AG, Sägereistrasse 28,
8152 Glattbrugg
Designer: Christopher T. Hunziker, Zürich
Vertreter: Schneider Feldmann AG, Patent- und
Markenanwälte, 8022 Zürich



1

Cl. 06-03 134 800 07.02.2008
 2 Design – Tische
 Hinterleger: Roland Stucki, Neuwilstrasse 9, 9306 Freidorf TG
 Beschreibung des Designs: T105
 Ich möchte ein Tisch mit Hauptbein Naturstein schützen. Der Stein ragt durch das Tischblatt. Die Metallrohre dienen nur der Abstützung.



T105

T207
 Der aufgehängte Stein unter dem Tischblatt, wirkt der Erdanziehungskraft auf das Blatt gegen. Eine Versteifung in Längsrichtung ist auch feststellbar. Das untere Travers übernimmt die grösste Versteifung an längs und Breitseite des Tisches



T207

Cl. 06-04 134 801 07.02.2008
 1 Design – Regalmodul
 Hinterleger: DESIGN BUREAU COLIN SCHÄLLI,
 Hardstrasse 219, 8005 Zürich
 Designer: Colin Schälli, Zürich



03

Cl. 07-04 134 803 05.02.2008
 1 Design – Gewürzmühle
 Hinterleger: DKB Household UK Limited, Bridge House,
 Eelmoor Road, Farnborough, Hampshire GU14 7UE, GB
 Designer: Daniel Kestenbaum, London
 Vertreter: ABACUS Patentanwälte, Klocke Späth Barth,
 8134 Adliswil
 Priorität: EM, 06.08.2007

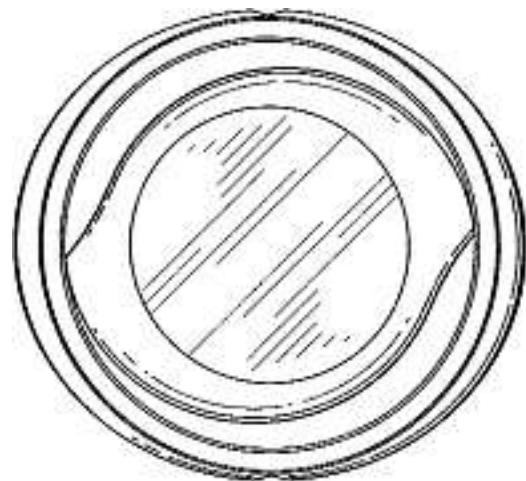
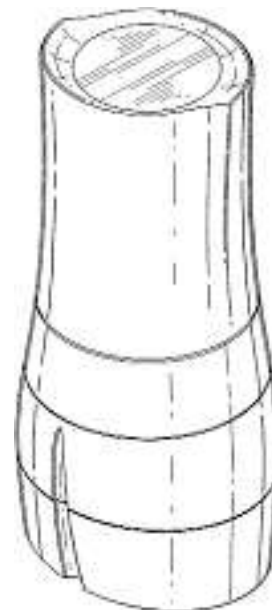

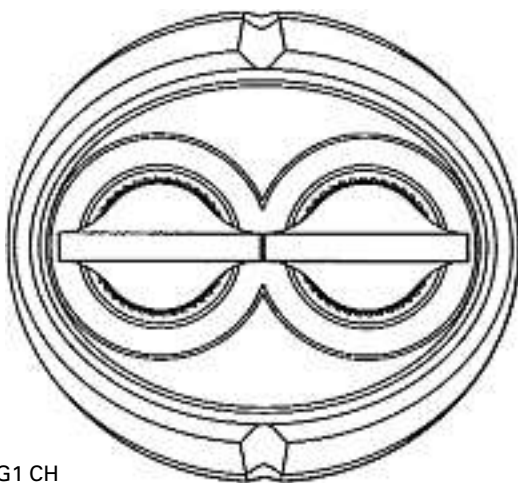
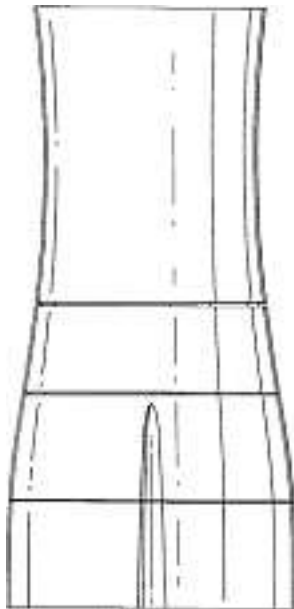
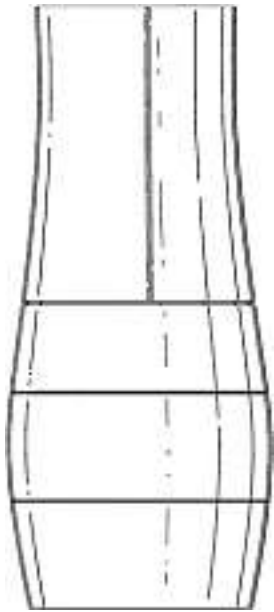

KIS-G1 CH

Cl. 07-99 134 804 29.01.2008
 1 Design – Ablagebehälter
 Hinterleger: William Peng, Scharfenstrasse 15, 5400 Baden

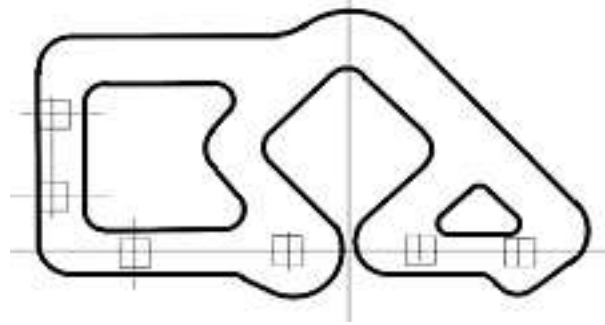

080202-1

Cl. 08-05 134 806 11.02.2008
 1 Design – Keil
 Hinterleger: Moxi AG, Untergasse 23, 2502 Biel
 Designer: Romeo Burkhalter, Biel; Andrea Dreier, Biel;
 Christoph Lanz, Biel
 Beschreibung des Designs: Keil, der das Wackeln eines
 Tisches verhindert und zugleich für ein Produkt, eine
 Dienstleistung oder eine Firma werben kann.

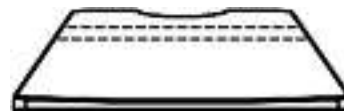

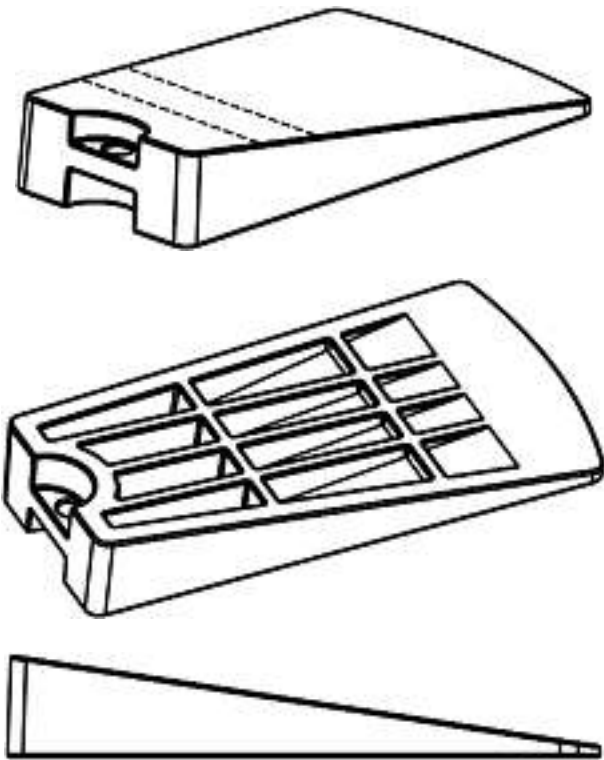

Tischkeil

Cl. 08-08 134 807 04.02.2008

2 Design – Klemmstücke

Hinterleger: Hugo Weber, Weitmoos, 3764 Weissenburg

Vertreter: Felber & Partner AG, 8034 Zürich

Beschreibung des Designs: Das Klemmstück mit Fortsatz und Loch oder Nocken im Loch wird über eine Gewindestange gestülpt, die in seinen Innendurchmesser einpasst, und dann wird es zwischen zwei Rohren mit zur Gewindestange passendem Innengewinde eingeklemmt, sodass eine Gestellstütze gebildet wird, mit senkrecht dazu abstehendem Fortsatz. Das Klemmstück ist dazu bestimmt, mit seinem Fortsatz ein Tablar aus Holz, Glas oder Kunststoff zu tragen. Zwei aufeinanderliegende Klemmstücke mit je einem Ring, der halb so dick ist wie der Fortsatz, dienen zum Tragen von Tablaren auf zwei gegenüberliegenden Seiten einer Gestellstütze.



1



2

Cl. 08-99 134 808 06.02.2008

2 Design – Kettenverbindungsglied

Hinterleger: Confon AG, Langenhag 31, 9424 Rheineck

Designer: Werner Preusker, Sauldorf

Vertreter: Hans Rudolf Gachnang, Patentanwalt, 8501 Frauenfeld

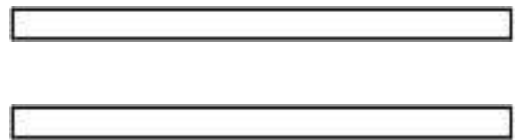
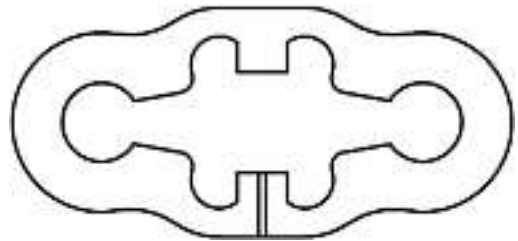
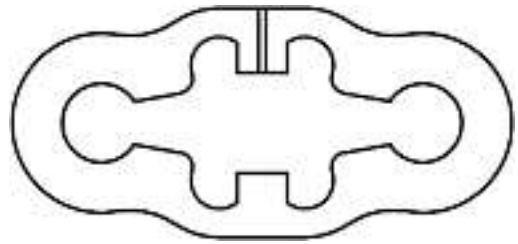

1

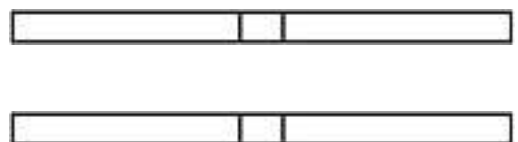
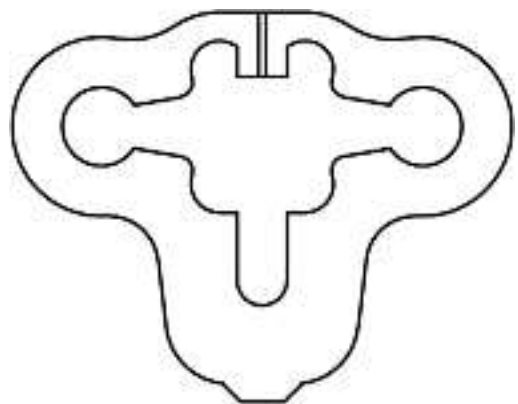

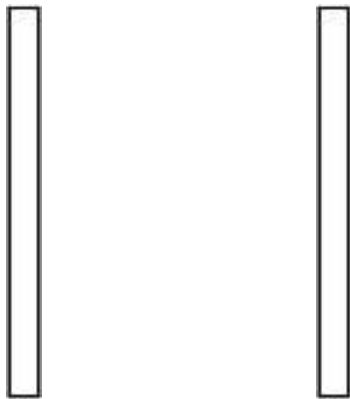
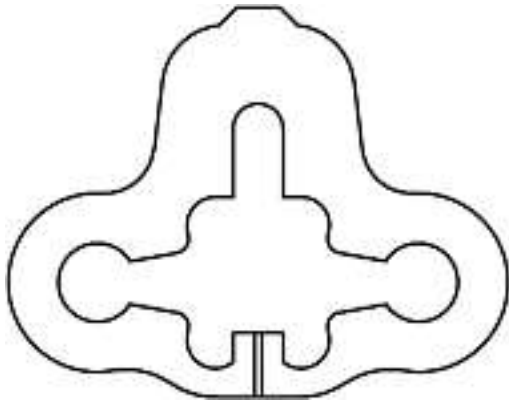

2

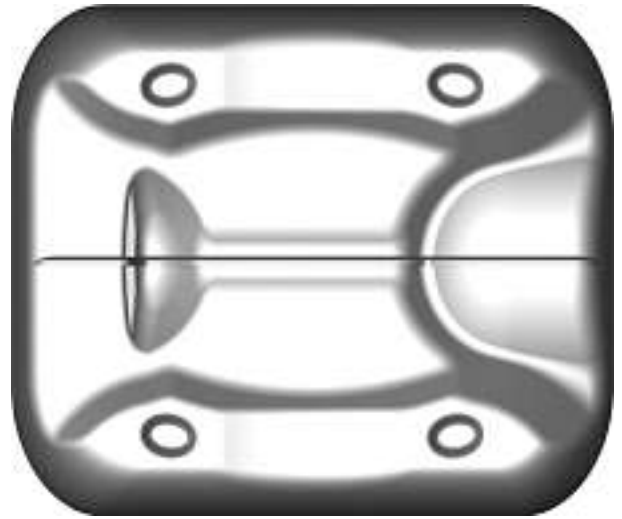

Cl. 09-02 134 810 20.01.2008
1 Design – Kanister
Hinterleger: Fischer Söhne AG, Luzernerstrasse 105,
Postfach 119, 5630 Muri AG
Designer: Bernard Acker, Ligsdorf

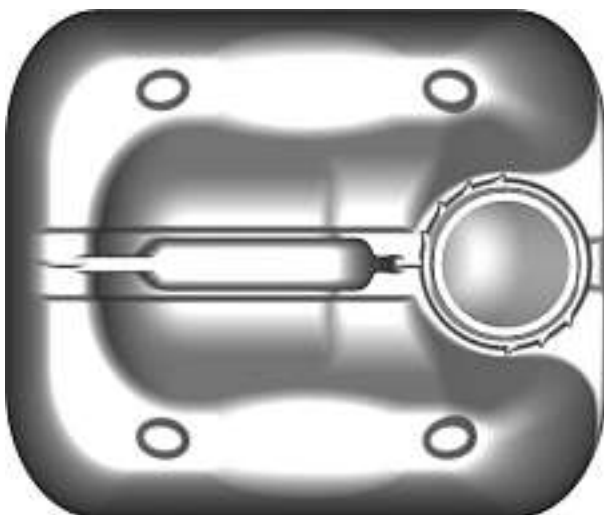

K8

Cl. 09-03 134 811 31.01.2008
2 Design – Hygienebox
Hinterleger: Rita Lucas-Jacobsen, Grosse Bergstrasse 193,
22767 Hamburg, DE
Vertreter: Ralph E. Amacher, 8702 Zollikon
Priorität: DE, 14.08.2007

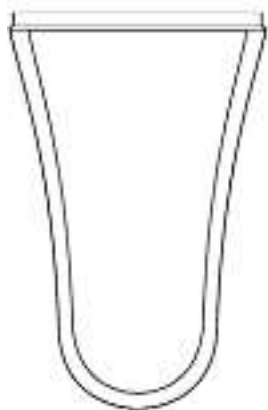
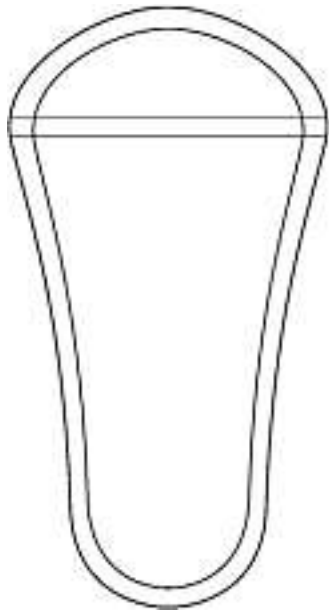

1

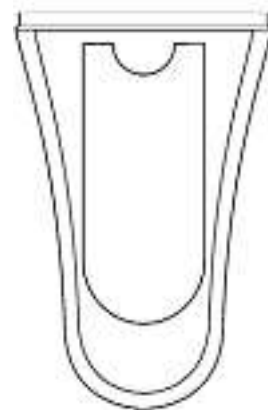
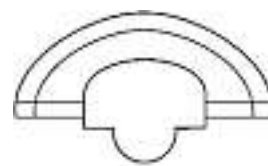
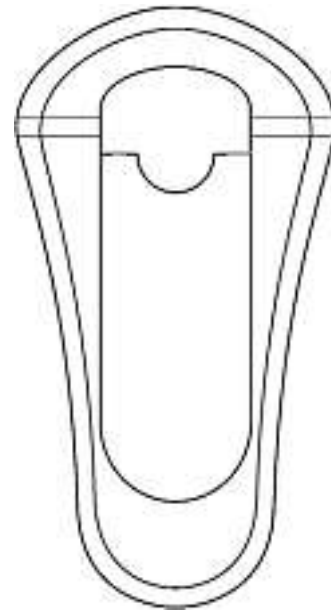

2

Cl. 10-02 134 812 28.01.2008
 1 design – montre
 Déposant: Idea Concept SA, Chemin des Barres 9,
 2345 Les Breuleux
 Designer: Nicolas Juillerat, Le Noirmont



01-2008

Cl. 11-01 134 816 08.02.2008
 2 Design – Schmuckstücke
 Hinterleger: Meister + Co AG, Hauptstrasse 66, 8832 Wollerau
 Designer: Fabian Meister, Altendorf; Silvio Daldini, Kilchberg
 ZH; Thomas Geiser, Schübelbach; Marcus Siessegger, Wald

Beschreibung des Designs: Astrodisc
 Symbolisch sind die Planetenpositionen in Ihrem Lauf durch die 12 Tierkreiszeichen zum Zeitpunkt der Geburt dargestellt. Die einmalige Grafik liegt einer exakten mathematische Berechnung der individuellen Angaben von Geburtsdatum, Geburtszeitpunkt und Geburtsort des Kunden zugrunde und wird per Lasergravur auf das Amulett aufgebracht.



1.183.1729

Beschreibung des Designs: Fingerprint Amulett.
 Der individuelle Fingerabdruck des Kunden wird per Lasergravur als Textur auf das Amulett aufgebracht.



2.183.1730

Cl. 11-02 134 817 04.02.2008

1 Design – Verbundglasplatte
 Hinterleger: Waldag Holding AG, Uferstrasse 12,
 4414 Füllinsdorf
 Designer: Paul Waldvogel, Pratteln
 Vertreter: Felber & Partner AG, 8034 Zürich
 Beschreibung des Designs: Die gebrochene Verbundglasplatte wird auf einer Kartonunterlage liegend und mit einer Folie umspannt verkauft, sodass die Bruchstücke nicht auseinanderfallen. Nach dem Auspacken aus der Folie werden Teile der Platte, bestehend aus einer Vielzahl von Bruchstücken, auf einen mit Silikonleim bestrichenen Gegenstand gelegt und darauf festgeklopft. Die einzelnen Bruchstücke, zwischen denen unregelmässig Abstände entstehen, werden hernach mit einer Fugenmasse verfügt, sodass ein mosaikartiges Ornament entsteht.

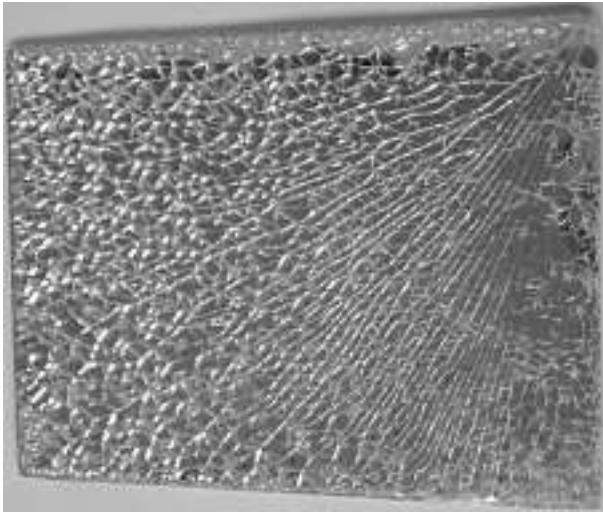

1

Cl. 12-08 **134 818** 04.02.2008
 1 design – automobile
 Depositante: Honda Motor Co., Ltd., No. 1-1, 2-chome,
 Minami-aoyama, Minato-ku, Tokyo, JP
 Designer: Toshiyuki Okumoto, Saitama; Tsutomu Fujita,
 Saitama
 Mandatario: Fiammenghi-Fiammenghi, 6900 Lugano
 Priorità: JP, 22.08.2007

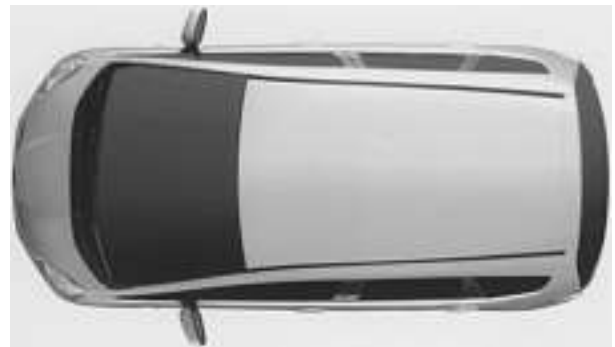

509

Cl. 12-11 **134 819** 31.01.2008
 1 Design – Motorrad-Seitenabdeckung
 Hinterleger: Honda Motor Co., Ltd., No. 1-1, 2-chome,
 Minami-aoyama, Minato-ku, Tokyo, JP
 Designer: Witoon Rerksiriwan, Bangkok; Yutapong
 Damroong, Bangkok
 Vertreter: E. Blum & Co. AG, Patent- und Markenanwälte
 VSP, 8044 Zürich
 Priorität: JP, 08.08.2007



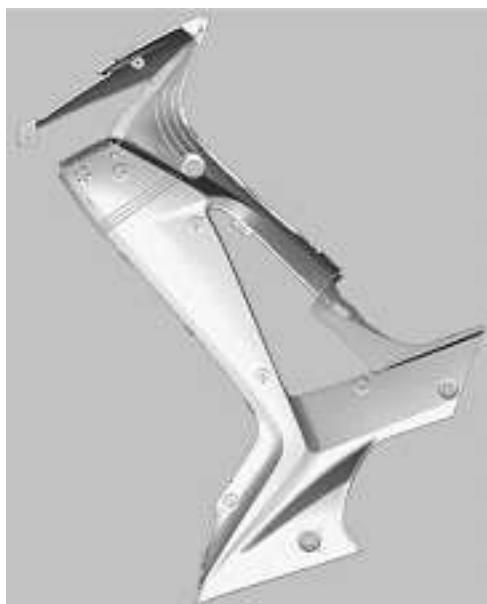



1

Cl. 12-16 **134 820** 15.02.2008
 2 Design – Dachspoiler, Unterfahrerschutz
 Hinterleger: APS Werk AG, Wasserstrasse 37, 8340 Hinwil
 Designer: Fritz von Ow, Hinwil; Ralph von Ow, Hinwil



Dachspoiler: Nr. 165



Unterfahrerschutz: Nr. UFS 5a

Cl. 14-01 **134 821** 30.01.2008
 2 design – altoparlante
 Depositante: Gerardo Wuthier, via Predasco, 6652 Tegna;
 Mattia Chiesa, via ai Molini 6, 6616 Losone
 Designer: Gerardo Wuthier, Tegna
 Mandatario: Mattia Chiesa, 6616 Losone



Utòpia



Numaga

Cl. 14-03 134 822 25.01.2008
 1 Design – Mobiltelefon
 Hinterleger: Sony Ericsson Mobile Communications AB,
 Nya Vattentornet, Lund, SE
 Designer: Benjamin Fagnot, Malmö
 Vertreter: Isler & Pedrazzini AG, 8027 Zürich
 Priorität: EM, 27.07.2007

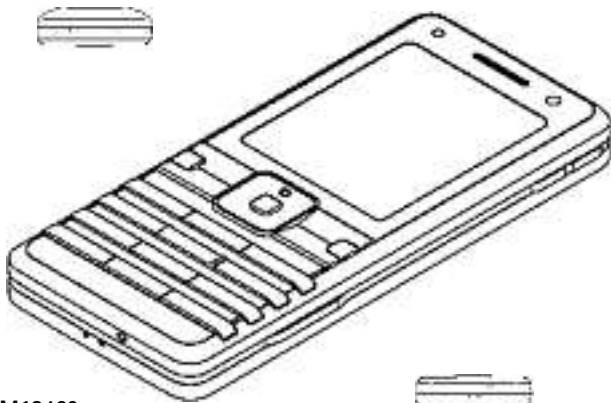
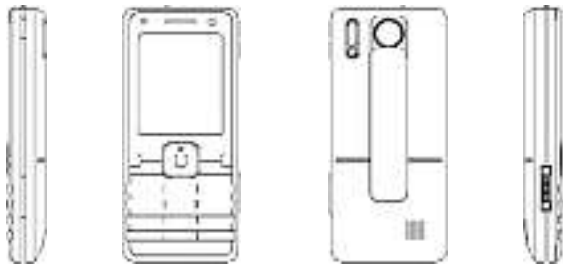

M13460

Cl. 14-04 134 823 11.02.2008
 1 Design – Bildschirmoberfläche
 Hinterleger: CeTris GmbH, Rigistrasse 158, 6340 Baar
 Designer: Manfred Jehle, Baar



Bildschirmoberfläche 1

Cl. 19-99 134 824 15.02.2008
 2 Design – Schreibtäfel
 Hinterleger: Wanobo GmbH, Sackmattstrasse 22,
 2575 Gerolfingen
 Designer: Carlo Wyssbrod, Gerolfingen



1



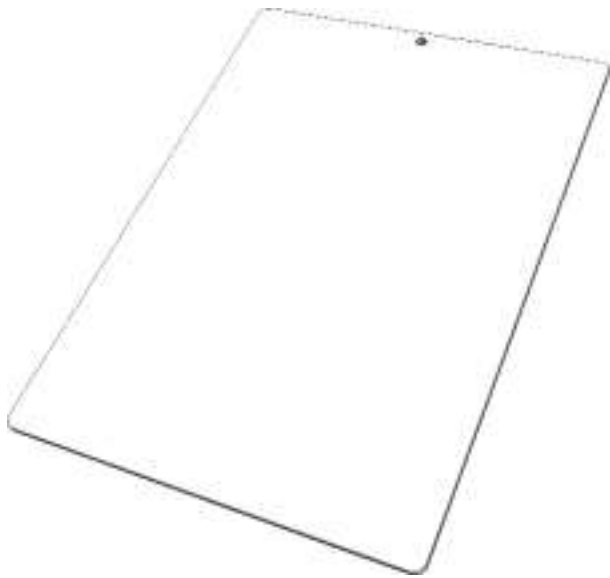

2

Cl. 20-03 **134 825** 31.01.2008
 1 design – support publicitaire
 Déposant: Olivier Chevalley, Cité-Derrière 20, 1005 Lausanne

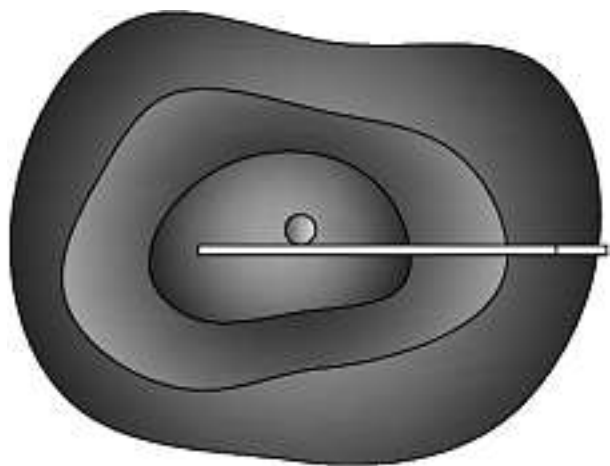

Alpin81

Cl. 21-01 **134 826** 28.01.2008
 1 Design – Spiel
 Hinterleger: Francesco Catarci, Arbachstrasse 63, 6340 Baar

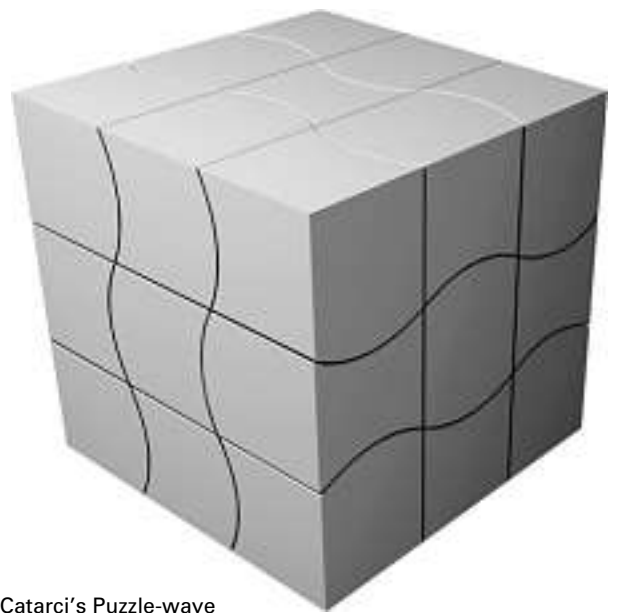
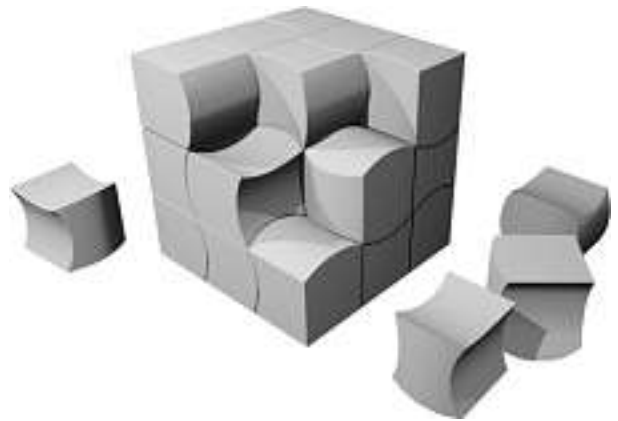

Catarci's Puzzle-wave

Cl. 21-01 134 827 31.01.2008
1 Design – Spiel- und Sportgerät
Hinterleger: Limmat Produkt GmbH, Hardturmstrasse 328,
8005 Zürich
Designer: Barbara Hiestand, Zürich

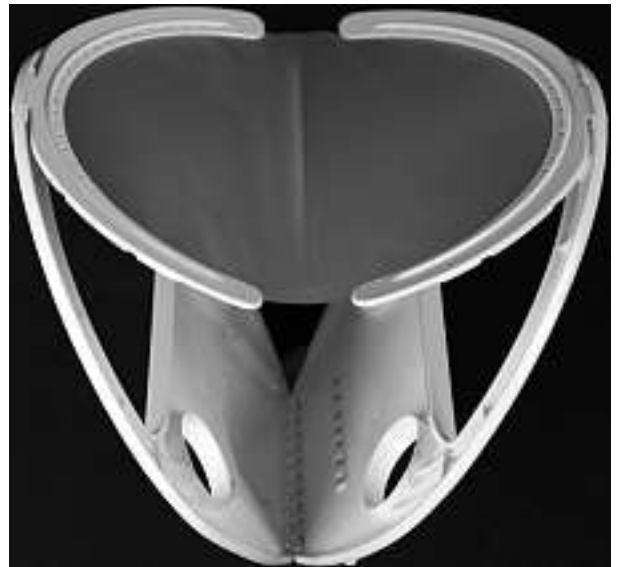

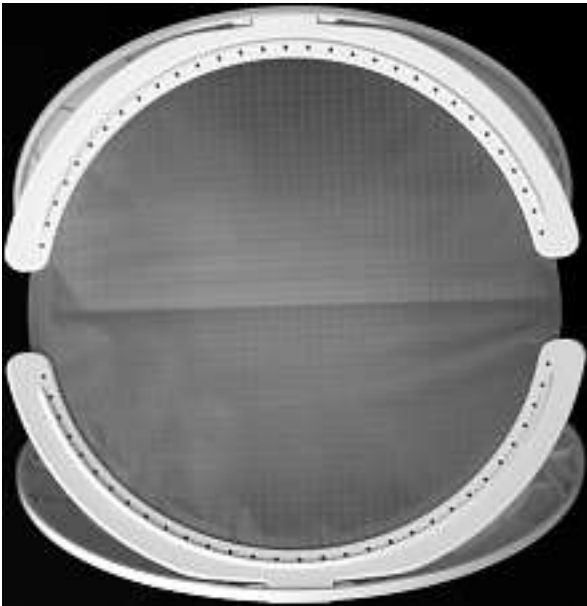

Squap

Cl. 21-01 **134 828** 18.02.2008
 2 design – jeu
 Déposant: L.G. Design Sàrl, Avenue Dapples 26,
 1006 Lausanne
 Designer: Singal Mösch, Bussigny



1:Colline du Flon avec lucarne



2:Colline du Flon sans lucarne

Cl. 23-02 **134 829** 07.02.2008
 1 Design – Spender
 Hinterleger: Unilever N.V., Weena 455, Rotterdam, NL
 Designer: Karim El Ghouyel, Paris; Armel André Paul
 Archeny, Blyes
 Vertreter: E. Blum & Co. AG, Patent- und Markenanwälte VSP,
 8044 Zürich
 Priorität: GB, 04.09.2007

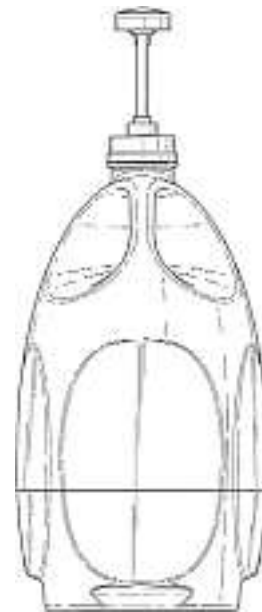

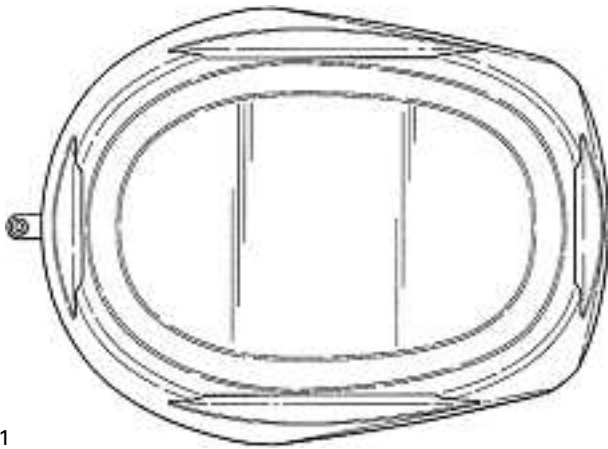
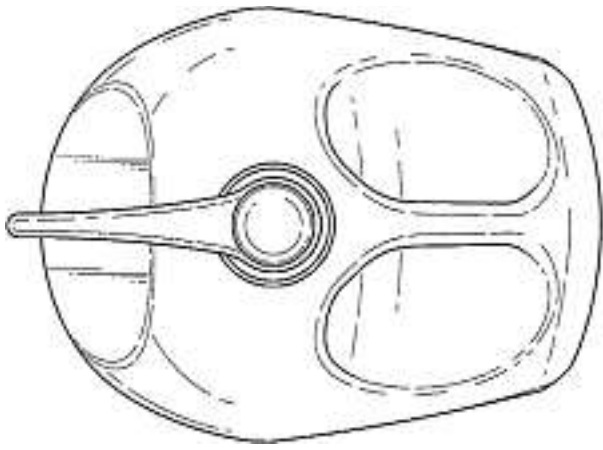

1

Cl. 24-04 134 830 31.01.2008
 1 Design – Slipeinlage
 Hinterleger: Rita Lucas-Jacobsen, Grosse Bergstrasse 193,
 22767 Hamburg, DE
 Vertreter: Ralph E. Amacher, 8702 Zollikon
 Priorität: DE, 14.08.2007

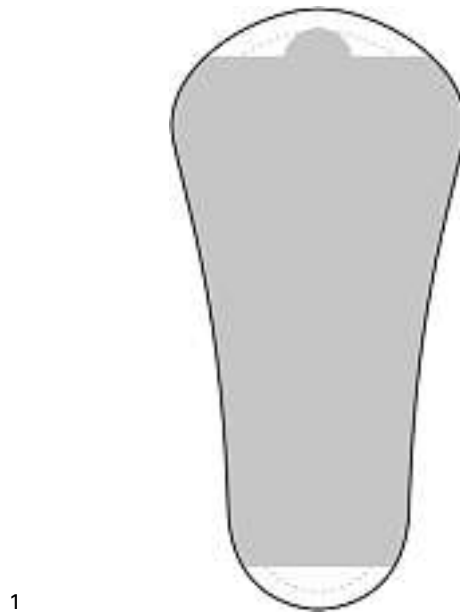
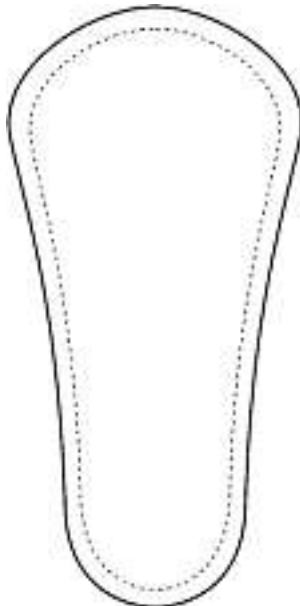

1

Cl. 24-99 134 831 04.02.2008
 1 Design – Medizinaltechnischer Gefässverschluss
 Hinterleger: INOVA MEDICAL AG, Alte Steinhauserstrasse 1,
 6330 Cham
 Designer: Ernst-Diethelm Harren, Cham
 Vertreter: R. A. Egli & Co., Patentanwälte, 8008 Zürich





Cl. 26-05 134 832 22.01.2008
2 Design - Lampe
Hinterleger: Herzog & de Meuron Architekten AG,
Rheinschanze 6, 4056 Basel
Designer: Jacques Herzog, Basel; Pierre de Meuron, Riehen
Vertreter: AXON Patent GmbH, 4147 Aesch

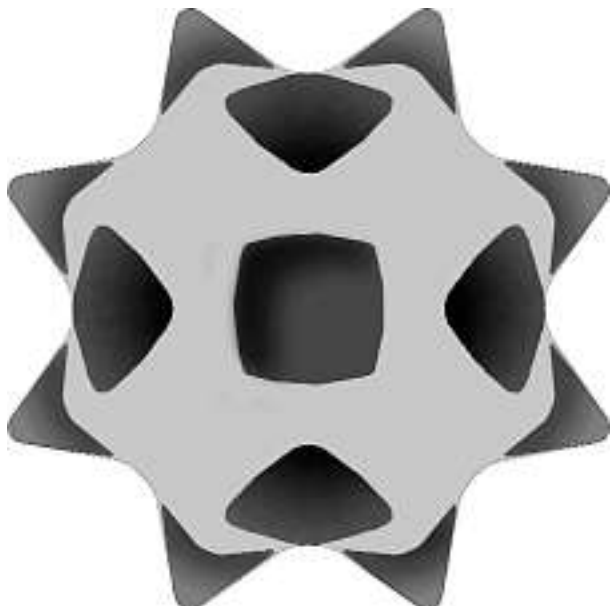
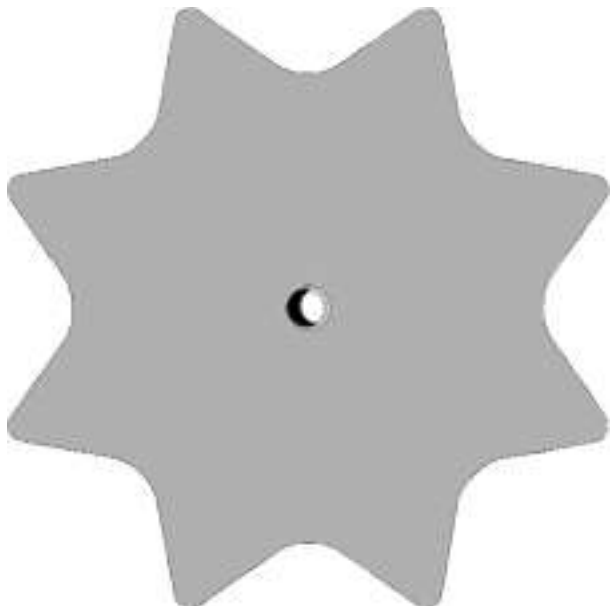

1

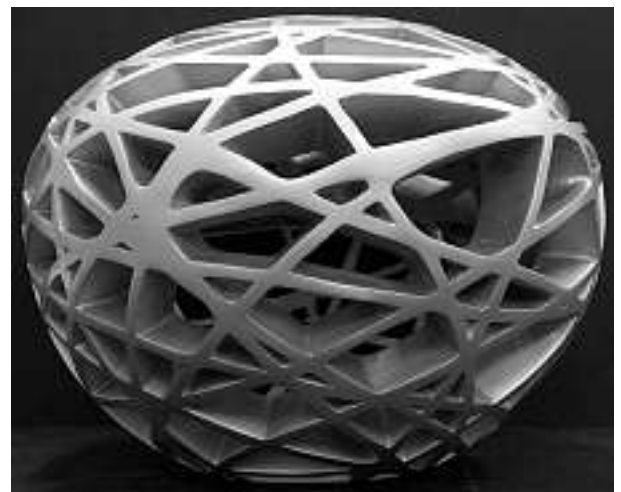
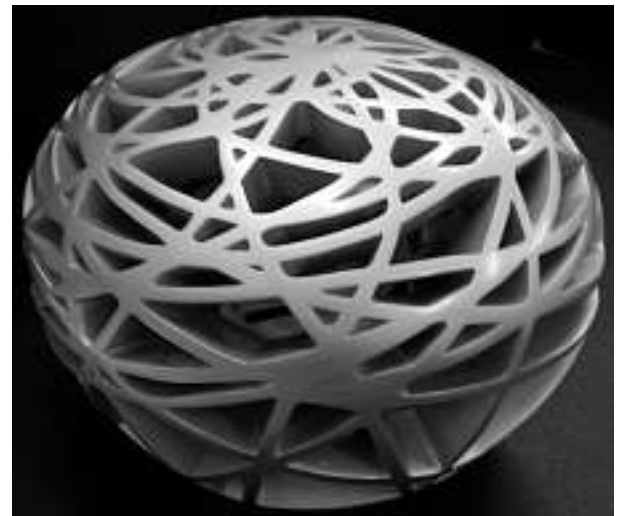



2

Cl. 26-06 134 833 31.01.2008
 1 Design – Motorrad-Frontlampe
 Hinterleger: Honda Motor Co., Ltd., No. 1-1, 2-chome,
 Minami-aoyama, Minato-ku, Tokyo, JP
 Designer: Witoon Rerksiriwan, Bangkok; Yutapong
 Damroong, Bangkok
 Vertreter: E. Blum & Co. AG, Patent- und Markenanwälte
 VSP, 8044 Zürich
 Priorität: JP, 08.08.2007





1

Cl. 26-06 **134 834** 04.02.2008
 3 design – gruppi ottici anteriori e posteriori per autovettura
 Depositante: Honda Motor Co., Ltd., No. 1-1, 2-chome,
 Minami-aoyama, Minato-ku, Tokyo, JP
 Designer: Toshiyuki Okumoto, Saitama; Yuji Terui, Saitama
 Mandatario: Fiammenghi-Fiammenghi, 6900 Lugano
 Priorità: JP, 22.08.2007; JP, 22.08.2007; JP, 22.08.2007





1





2





3

**Verlängerungen
Prolongations
Prolongazioni**

| | | | |
|---------|-----|-------|----------|
| 116 629 | Cl. | 10-02 | 1 design |
| 116 651 | Cl. | 99-00 | 2 Design |
| 116 757 | Cl. | 09-05 | 2 design |
| 120 467 | Cl. | 19-02 | 2 Design |

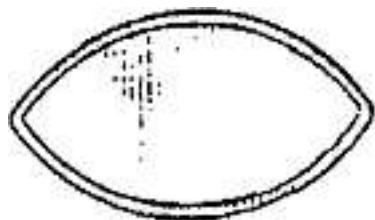
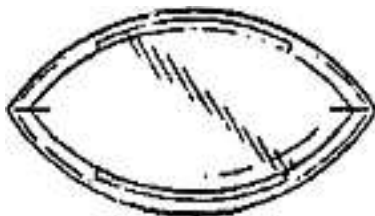
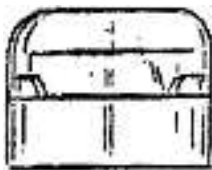
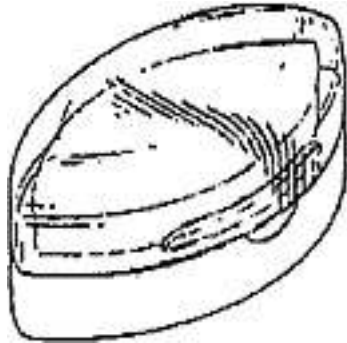

1

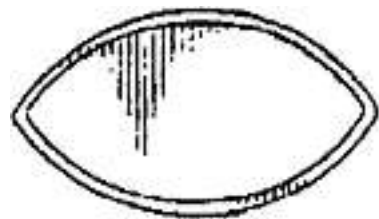
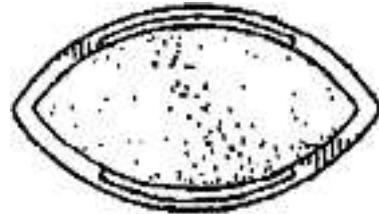
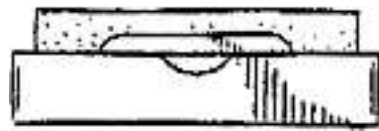
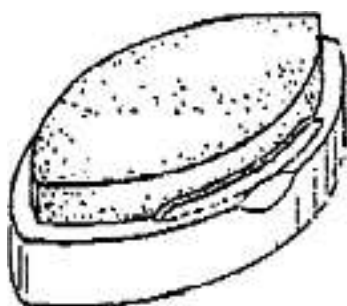

2

| | | | |
|---------|-----|-------|----------|
| 120 504 | Cl. | 20-02 | 1 Design |
|---------|-----|-------|----------|



RSVT 495

| | | | |
|---------|-----|-------|----------|
| 124 863 | Cl. | 24-01 | 1 Design |
| 124 936 | Cl. | 19-06 | 1 design |
| 124 943 | Cl. | 25-01 | 2 design |
| 125 068 | Cl. | 08-03 | 1 Design |
| 125 076 | Cl. | 10-05 | 2 Design |
| 125 122 | Cl. | 12-11 | 1 Design |
| 125 133 | Cl. | 26-05 | 1 Design |
| 125 147 | Cl. | 08-03 | 1 Design |
| 129 072 | Cl. | 09-01 | 1 Design |
| 129 434 | Cl. | 20-02 | 1 Design |
| 129 497 | Cl. | 06-01 | 3 Design |
| 129 544 | Cl. | 06-01 | 1 Design |
| 129 555 | Cl. | 09-01 | 2 Design |
| 129 558 | Cl. | 10-02 | 1 design |
| 129 572 | Cl. | 12-10 | 1 Design |
| 129 574 | Cl. | 14-03 | 1 Design |
| 129 580 | Cl. | 23-03 | 1 Design |
| 129 581 | Cl. | 23-04 | 1 Design |
| 129 583 | Cl. | 24-02 | 1 Design |
| 129 584 | Cl. | 24-02 | 1 Design |
| 129 585 | Cl. | 24-99 | 2 Design |
| 129 607 | Cl. | 09-03 | 1 Design |
| 129 608 | Cl. | 09-05 | 1 Design |
| 129 629 | Cl. | 14-99 | 1 design |
| 129 706 | Cl. | 19-02 | 5 Design |
| 129 710 | Cl. | 24-02 | 7 Design |
| 129 773 | Cl. | 07-01 | 1 Design |
| 129 988 | Cl. | 10-04 | 1 Design |
| 130 001 | Cl. | 15-09 | 1 design |
| 130 076 | Cl. | 06-03 | 5 Design |
| 130 096 | Cl. | 10-07 | 1 design |

Mutationen Modifications Modificazioni

116 651

Namensänderung/ Neuer Vertreter

Hinterleger: Kehrer Stebler AG Metallbau, Südringstrasse 6, 4702 Oensingen

Vertreter: Keller & Partner, Patentanwälte AG, 3000 Bern 7

124 702

Namensänderung

Hinterleger: Ernst Sutter AG, Management, Schwerzistrasse 34, Postfach 448, 8807 Freienbach

127 679

130 984

Trasmissione

Depositante: Stefano Mondini, Biolda, 6950 Tesserete

Mandatario: Fiammenghi-Fiammenghi, 6900 Lugano

128 416

Renonciation au mandat

129 557

133 816

Transmission/ Transmission

Déposant: TechnoMarine SA, Rue de la Rôtisserie 2, 1204 Genève

Déposant: TechnoMarine SA, Succursale Luxembourg, 43, Boulevard du Prince Henri, 1724 Luxembourg, LU
Mandataire: Inteltech SA, 2001 Neuchâtel

129 607

Neuer Vertreter

Vertreter: Kirker & Cie S.A., Ingénieurs-Conseils, 1226 Genève – Thônex

130 911

Transmission

Déposant: CreaLuxe SA, 16, quai du Seujet, 1201 Genève

Mandataire: P&TS Patents & Technology Surveys SA, 2001 Neuchâtel

131 706

Übertragung

Hinterleger: Kraft Foods Holdings, Inc., Three Lakes Drive, Northfield, IL 60093, US

Vertreter: E. Blum & Co. AG, Patent- und Markenanwälte VSP, 8044 Zürich

132 911

Transmission

Déposant: YSL BEAUTE, 28/34 Boulevard du Parc, 92521 Neuilly-sur-Seine Cedex, FR

Mandataire: Griffes Consulting S.A., 1206 Genève

**Löschungen
Radiations
Radiazioni**

| | | | |
|---------|-----|-------|-----------|
| 116 167 | Cl. | 10-02 | 1 design |
| 119 937 | Cl. | 09-01 | 1 Design |
| 119 947 | Cl. | 14-03 | 1 Design |
| 124 414 | Cl. | 07-01 | 1 Design |
| 124 415 | Cl. | 08-03 | 12 design |
| 124 422 | Cl. | 10-07 | 1 Design |
| 124 428 | Cl. | 12-08 | 1 Design |
| 124 451 | Cl. | 08-08 | 1 Design |
| 124 452 | Cl. | 09-01 | 1 Design |
| 124 469 | Cl. | 19-08 | 1 Design |
| 124 479 | Cl. | 26-02 | 1 Design |
| 124 525 | Cl. | 09-03 | 1 Design |
| 124 536 | Cl. | 13-03 | 2 Design |
| 124 550 | Cl. | 24-04 | 2 Design |
| 129 043 | Cl. | 04-02 | 1 Design |
| 129 052 | Cl. | 14-03 | 1 design |
| 129 055 | Cl. | 19-02 | 1 Design |
| 129 056 | Cl. | 21-02 | 1 Design |
| 129 062 | Cl. | 28-03 | 1 design |
| 129 104 | Cl. | 10-02 | 4 Design |
| 129 153 | Cl. | 14-02 | 2 design |
| 129 163 | Cl. | 21-01 | 1 Design |