

## Nationale Hinterlegungen

In der folgenden Liste werden die beim Eidgenössischen Institut für Geistiges Eigentum hinterlegten Designs publiziert. Dabei sind der Reihe nach angegeben:

- internationale Klassenangaben
- Hinterlegungsnummer
- Hinterlegungsdatum
- Allenfalls Aufschub der Veröffentlichung
- Anzahl der hinterlegten Designs
- Bezeichnung
- Name und Wohnsitz des Hinterlegers oder der Hinterlegerin
- gegebenenfalls Name und Wohnsitz des Designers oder der Designerin
- Name und Geschäftssitz des allfälligen Vertreters oder der Vertreterin
- gegebenenfalls Prioritätsangaben
- gegebenenfalls Beschreibungstext
- Ordnungsnummer
- Reproduktion des Designs

## Internationale Hinterlegungen

Die bei der Weltorganisation für geistiges Eigentum in Genf hinterlegten Muster und Modelle mit Benennung Schweiz geniessen den gleichen Schutz wie national hinterlegte Designs. Sie werden jeweils im Blatt «Bulletin des dessins et modèles internationaux» veröffentlicht. Dieses Publikationsorgan ist deshalb für eine vollständige Recherche unbedingt beizuziehen.

## Topographien

Angaben über die vom Eidgenössischen Institut für Geistiges Eigentum eingetragenen Topographien von Halbleitererzeugnissen werden in folgender Anordnung aufgeführt:

- Eintragsnummer
- Anmeldedatum
- Bezeichnung
- Name und Wohnsitz des Anmelders oder der Anmelderin
- gegebenenfalls Name und Wohnsitz des Herstellers oder der Herstellerin
- Name und Geschäftssitz des oder der allfälligen Bevollmächtigten
- Datum und Ort einer allfälligen ersten geschäftlichen Verbreitung der Topographie

## Dépôts nationaux

Les designs déposés à l'Institut Fédéral de la Propriété Intellectuelle sont publiés dans la liste qui suit. Les indications y relatives sont mentionnées dans cet ordre:

- indications des classes internationales
- numéro de dépôt
- date de dépôt
- le cas échéant, ajournement de la publication
- nombre des designs déposés
- désignation
- nom et domicile du/de la déposant/e
- le cas échéant, nom et domicile du/de la designer
- nom et domicile de l'éventuel/le mandataire
- le cas échéant, indication de priorité
- le cas échéant, description du design
- numéro attribué à chaque design
- reproduction du design

## Dépôts internationaux

Les dessins et modèles déposés à l'Organisation Mondiale de la Propriété Intellectuelle à Genève qui désignent la Suisse jouissent de la même protection que les dépôts nationaux. Ils sont chaque fois publiés dans la feuille «Bulletin des dessins et modèles internationaux». Pour une recherche complète, il est indispensable de consulter ledit organe de publication.

## Topographies

Les indications concernant les topographies des produits semi-conducteurs, enregistrées par l'Institut Fédéral de la Propriété Intellectuelle, sont énumérées dans l'ordre suivant:

- numéro d'enregistrement
- date de dépôt
- désignation
- nom et domicile du/de la déposant/e
- le cas échéant, nom et domicile du/de la producteur/trice
- nom et domicile de l'éventuel/le mandataire
- date et lieu d'une éventuelle première mise en circulation de la topographie

## Depositi nazionali

Nella lista seguente vengono pubblicati i design depositati presso l'Istituto Federale della Proprietà Intellettuale. Sono menzionati nel seguente ordine:

- indicazioni delle classi internazionali
- numero di deposito
- data del deposito
- se del caso, indicazione che la pubblicazione è stata differita
- numero dei design depositati
- designazione
- nome e domicilio del depositante
- se del caso, nome e domicilio del designer
- nome e sede di un eventuale mandataro
- se del caso, indicazioni di priorità
- se del caso, descrizione del design
- numero d'ordine
- riproduzione del design

## Depositi internazionali

I disegni e modelli depositati presso l'Organizzazione Mondiale della Proprietà Intellettuale a Ginevra con denominazione Svizzera godono della medesima protezione del deposito nazionale. Essi vengono pubblicati ogni volta nel foglio «Bulletin des dessins et modèles internationaux». Quest'organo di pubblicazione è da consultare se si vuole effettuare una ricerca completa.

## Topografie

Le indicazioni concernenti le topografie di prodotti a semiconduttori depositati presso l'Istituto Federale della Proprietà Intellettuale sono menzionate nell'ordine seguente:

- numero di registrazione
- data del deposito
- designazione
- nome e domicilio del/la richiedente
- se del caso, nome e domicilio del/la produttore/trice
- nome e sede di un eventuale mandataro
- data e luogo di un'eventuale prima messa in circolazione della topografia

## Hinterlegungen Dépôts Deposit

Cl. 14-03 132 613 20.02.2006  
 1 Design – Fernsehapparat  
 Hinterleger: Bang & Olufsen A/S, Peter Bangs Vej 15,  
 7600 Struer, DK  
 Designer: David Lewis, Kopenhagen  
 Vertreter: A.W. Metz & Co. AG, 8024 Zürich  
 Priorität: DK, 05.01.2006  
 Ende aufgeschobene Publikation

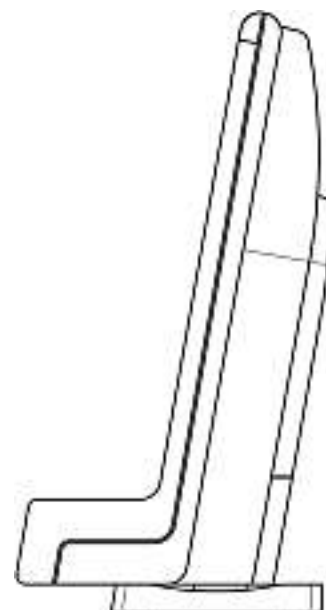
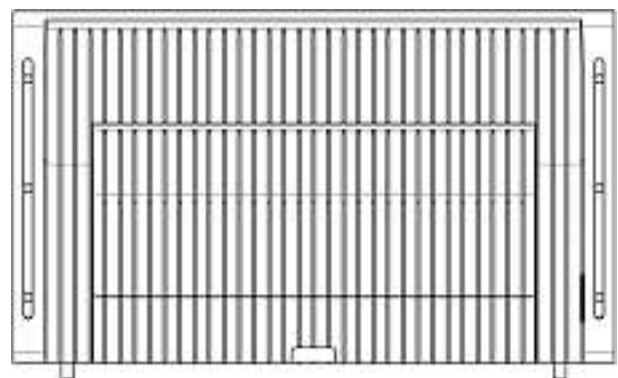
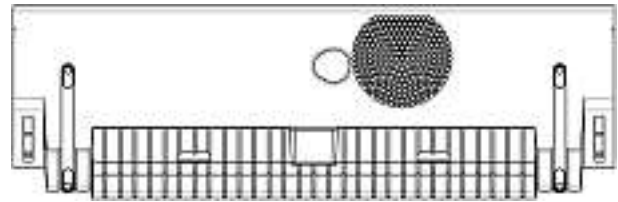
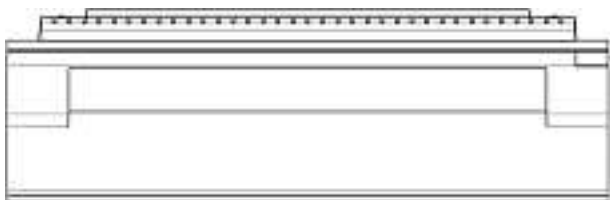
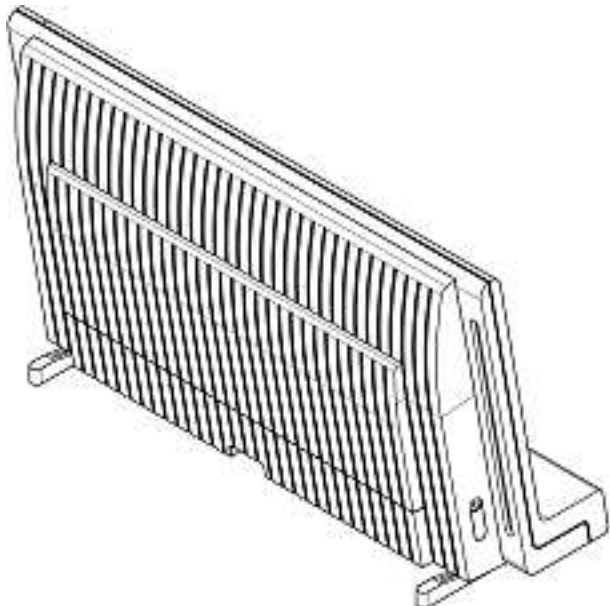
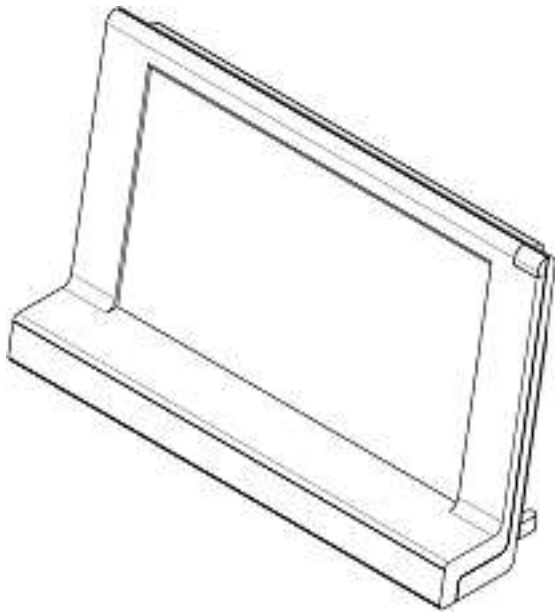

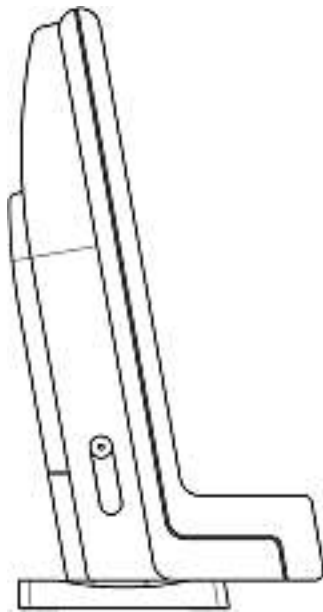

1763-CH-14-DS

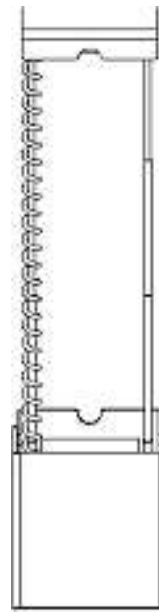

Cl. 14-02                      **134 240**                      29.08.2007  
1 Design – Datenverarbeitungsanlage  
Hinterleger: beyo GmbH, Hegelallee 5, 14467 Potsdam, DE  
Designer: Alexander Warth, Potsdam  
Vertreter: Lenz & Staehelin, Rechtsanwälte, 8027 Zürich  
Priorität: EM, 28.08.2007  
Ende aufgeschobene Publikation

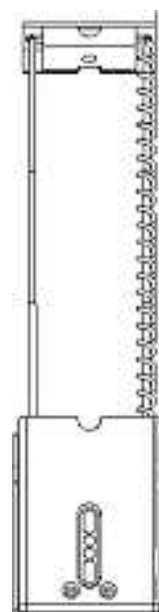
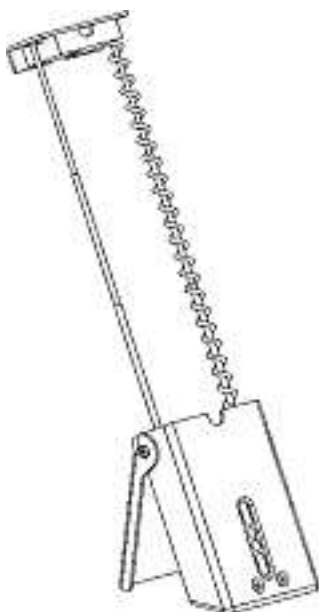
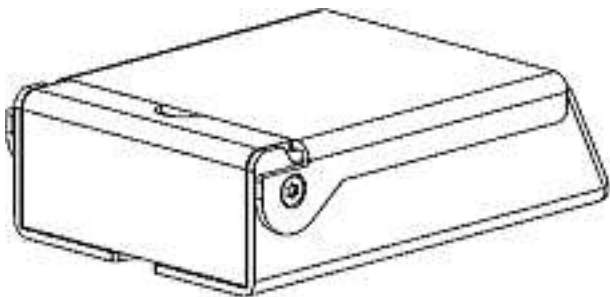



H001



H002



H003

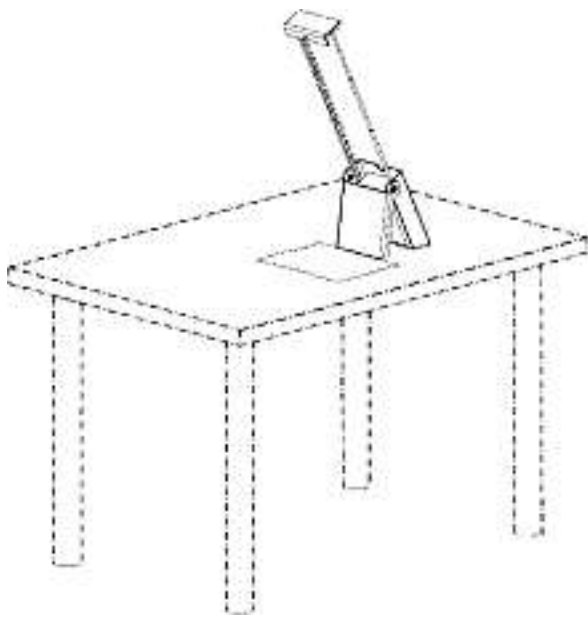

1

Cl. 02-05, 02-07      **134 981**      25.04.2008  
29 Design – Krawatten, Krawattenzubehör  
Hinterleger: Jürg Braun Design, Münchensteinerweg 22,  
4153 Reinach  
Designer: Jürg Braun, Reinach

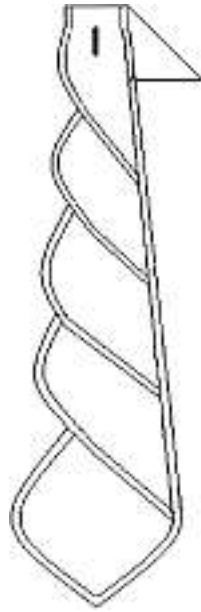

H004

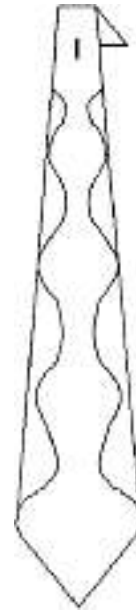

H008



H005

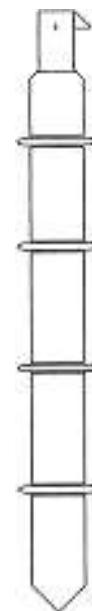

H009



H007



H010



H011

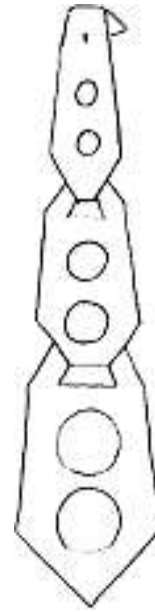

H014

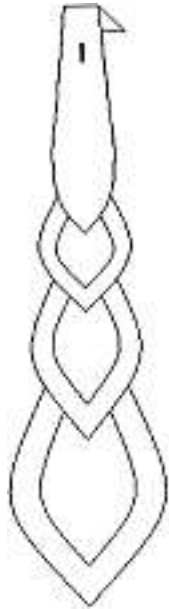

H012



H024

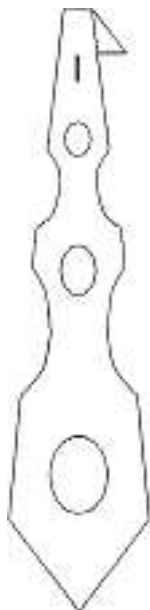

H013

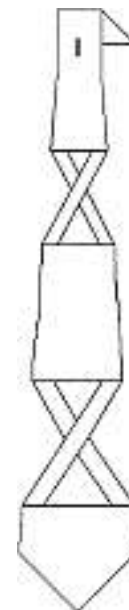

H025

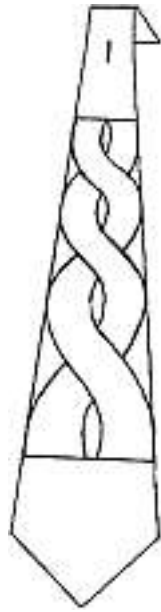

H026

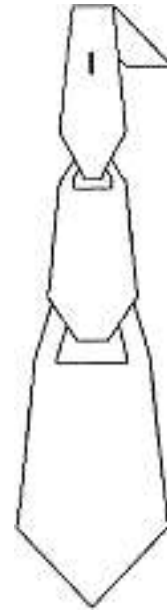

H029

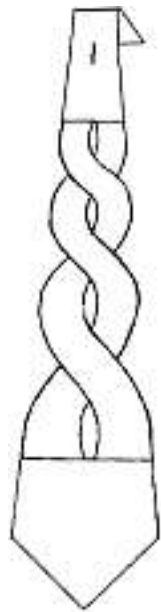

H027

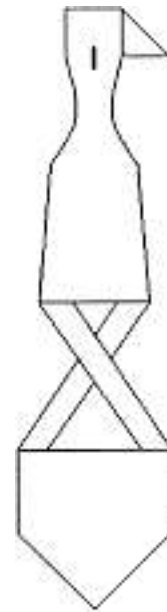

H030



H028

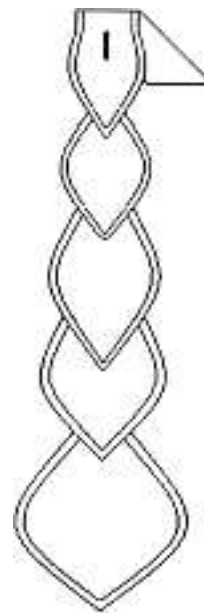

H031

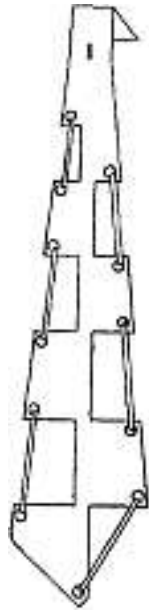

H033

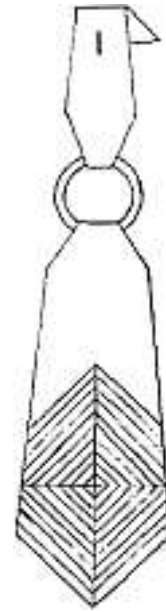

H039



H034



H044

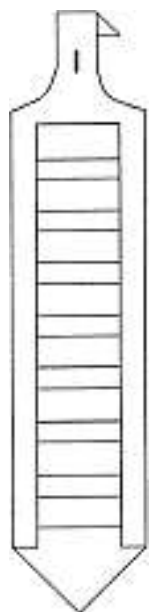

H038

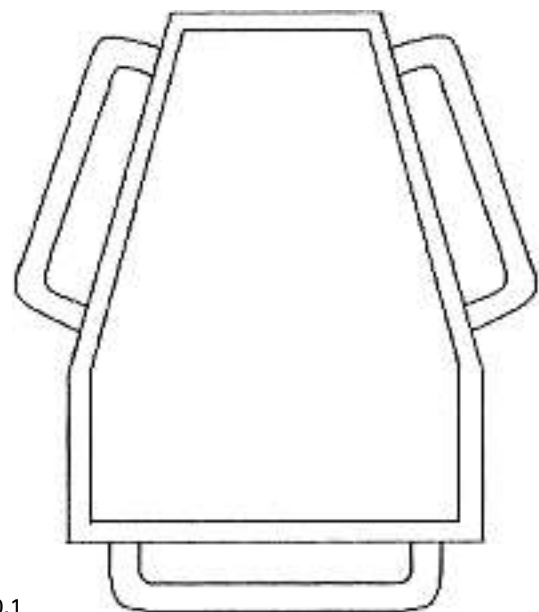

K20.1



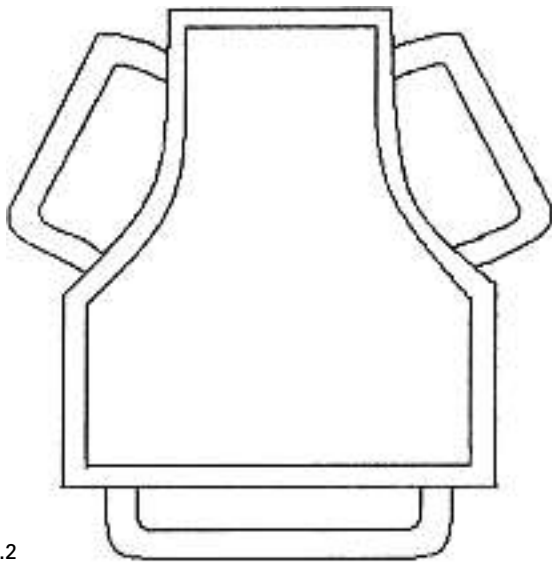

K20.2

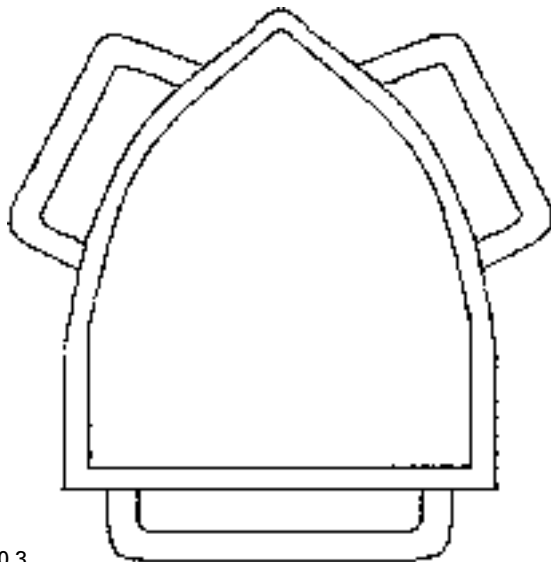

K20.3

Cl. 02-07 **134 982** 31.03.2008  
 1 design – ceinture  
 Déposant: David-Grégory Nocelli, 16 Rue de la Dôle,  
 1203 Genève



K-1

Cl. 02-07 **134 983** 31.03.2008  
 2 design – boutons de manchette  
 Déposant: Raymond Weil SA, 36-38, avenue Eugène-Lance,  
 1212 Grand-Lancy  
 Designer: Sébastien Actis-Datta, Villars-Tiercelin  
 Mandataire: Soprintel S.A., 2300 La Chaux-de-Fonds



1



2

Cl. 03-01 **134 984** 23.03.2008  
 2 Design – Taschen  
 Hinterleger: Ursina Scrowther, Usterstrasse 200,  
 8620 Wetzikon



baguette



bag IT

Cl. 06-01 134 985 03.04.2008  
1 Design – Stuhl  
Hinterleger: Vitra Patente AG, Klünenfeldstrasse 22,  
4132 Muttenz  
Designer: Jasper Morrison, London  
Vertreter: AXON Patent GmbH, 4147 Aesch





Cl. 06-01 134 986 03.04.2008  
2 Design – Stühle  
Hinterleger: Vitra Patente AG, Klünenfeldstrasse 22,  
4132 Muttenz  
Designer: Hella Jongerius, Rotterdam  
Vertreter: AXON Patent GmbH, 4147 Aesch





1





Cl. 06-01 134 987 03.04.2008  
2 Design – Stühle  
Hinterleger: Vitra Patente AG, Klünenfeldstrasse 22,  
4132 Muttenz  
Designer: Jasper Morrison, London  
Vertreter: AXON Patent GmbH, 4147 Aesch





1



2

Cl. 06-03 134 988 02.04.2008  
 1 design – table  
 Déposant: Jean-Jacques Putallaz, rue de l'Église 7, 1950 Sion



incision

Cl. 06-03 134 989 03.04.2008  
 1 Design – Tisch  
 Hinterleger: Vitra Patente AG, Klünenfeldstrasse 22,  
 4132 Muttenz  
 Designer: Antonio Citterio, Mailand  
 Vertreter: AXON Patent GmbH, 4147 Aesch



1

Cl. 06-04 134 990 26.03.2008  
 1 Design – Spiegelschrank  
 Hinterleger: Loosli Badmöbel AG, Gewerbestrasse,  
 4954 Wyssachen  
 Designer: Manfred Loosli, Wyssachen

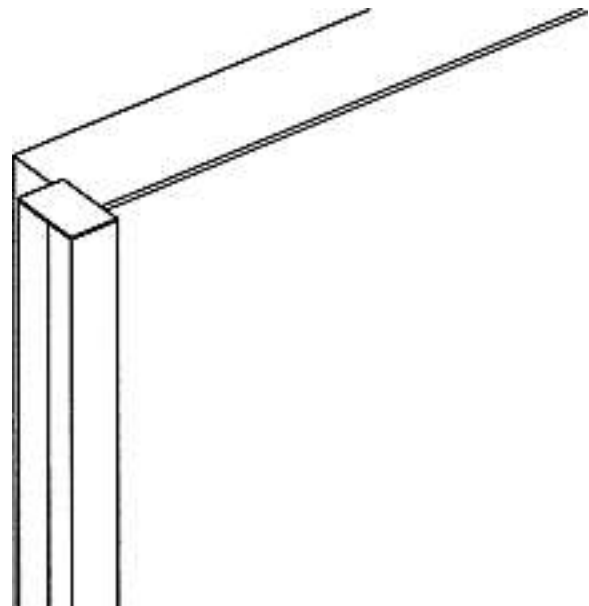

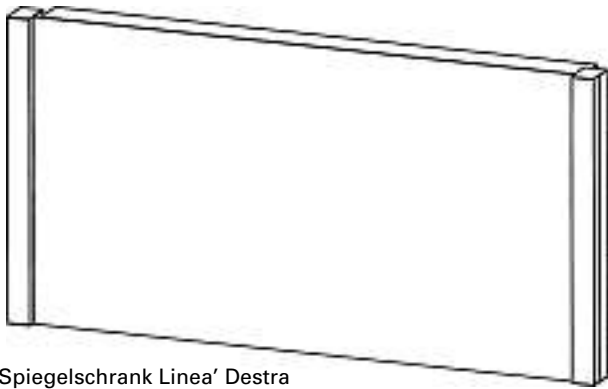

Spiegelschrank Linea' Destra

Cl. 06-06 134 991 31.03.2008  
 2 Design – Tischuntergestelle  
 Hinterleger: Reto Zimmermann, Im Bungert 23,  
 8306 Brüttisellen

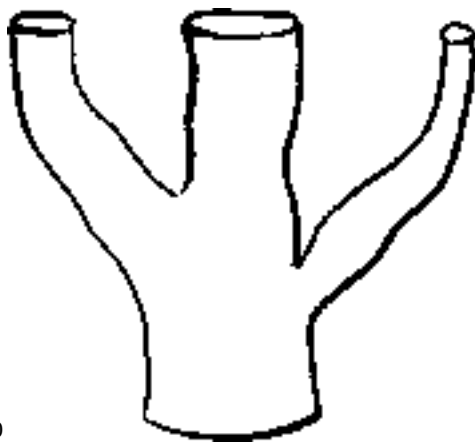

140300

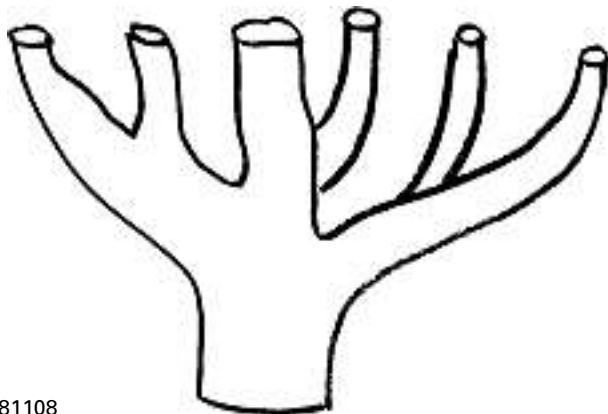

81108

Cl. 07-01 134 992 09.04.2008  
 4 Design – Behältnisse und deren Teile für Nahrungsmittel  
 Hinterleger: ABBOTT LABORATORIES, 100 Abbott Park Road,  
 Abbott Park, IL 60064-6008, US  
 Designer: James P. Perry, Gahanna; Craig A. McCardell,  
 Rochester Hills; Jeremy McBroom, New Albany; David  
 Compeau, Oxford; Ashley A. Gohlke, Chicago; William J.  
 Hook, Galena; Katherine J. Jordan, Pickerington; Frank S.  
 Walczak, Galena; Peter B. Clarke, Fairfield; J. Kevin Clay,  
 Milford  
 Vertreter: Patentanwälte Schaad, Balass, Menzl & Partner AG,  
 8034 Zürich  
 Priorität: US, 10.10.2007; US, 10.10.2007; US, 03.01.2008; US,  
 03.01.2008

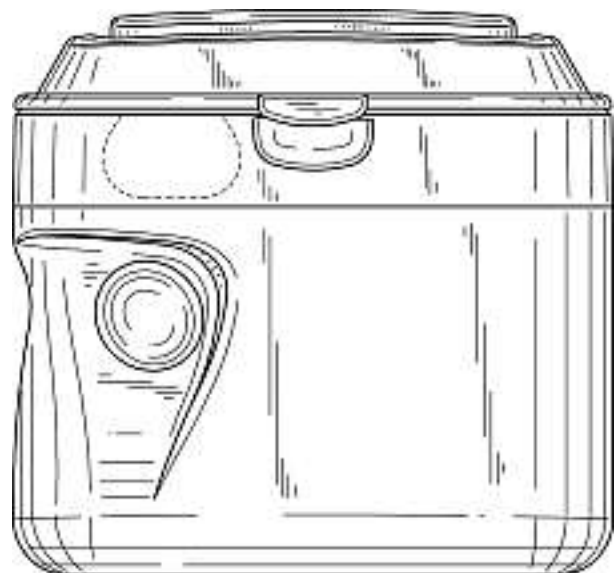
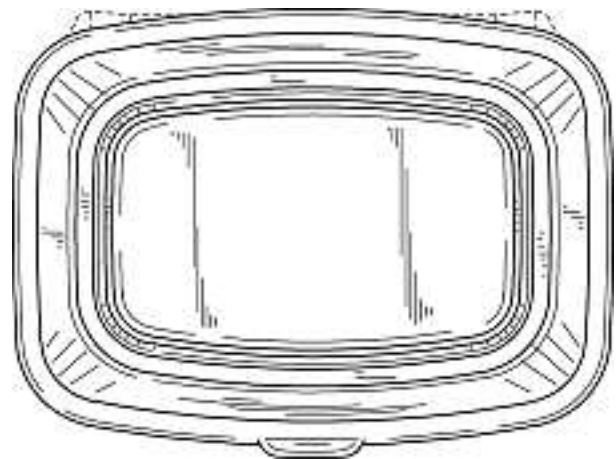
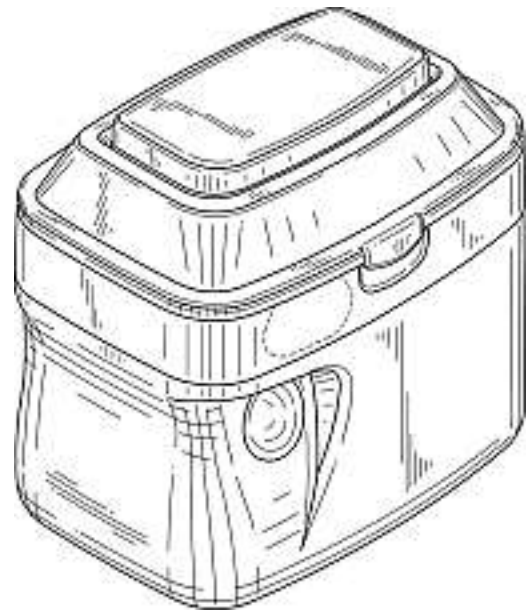



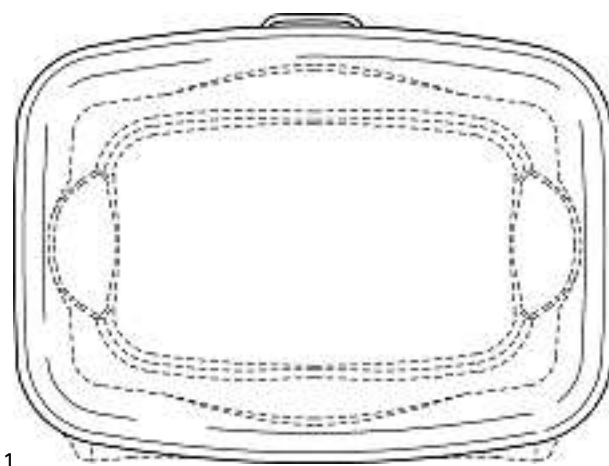
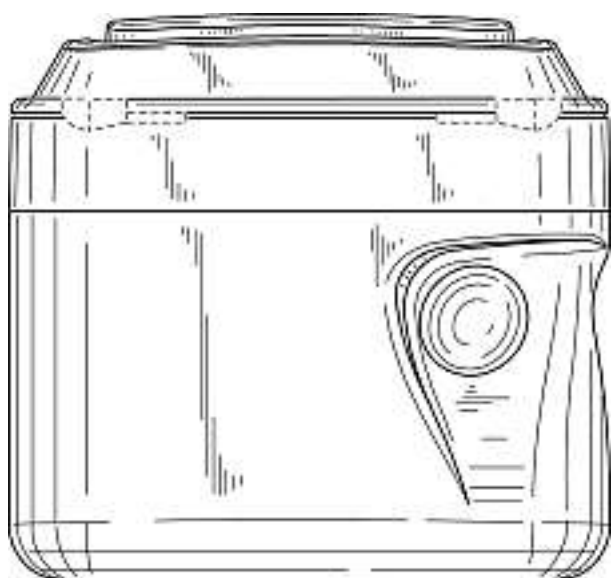

1

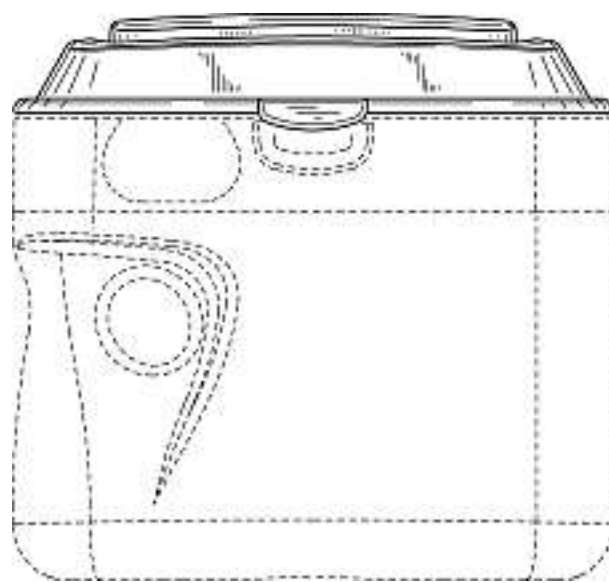
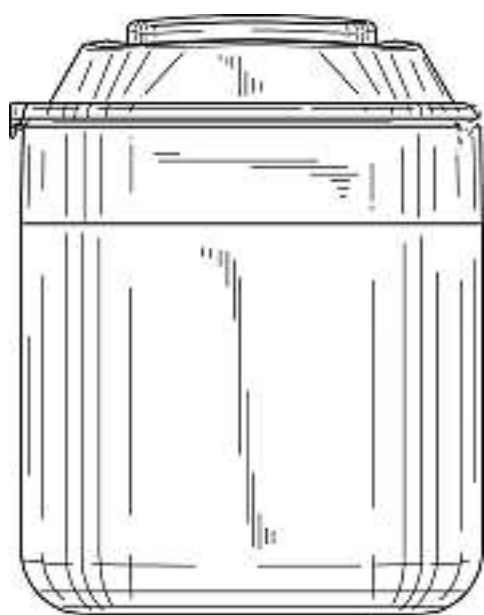
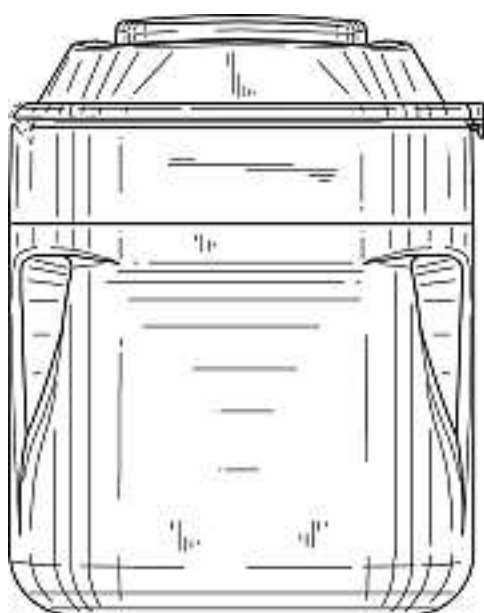

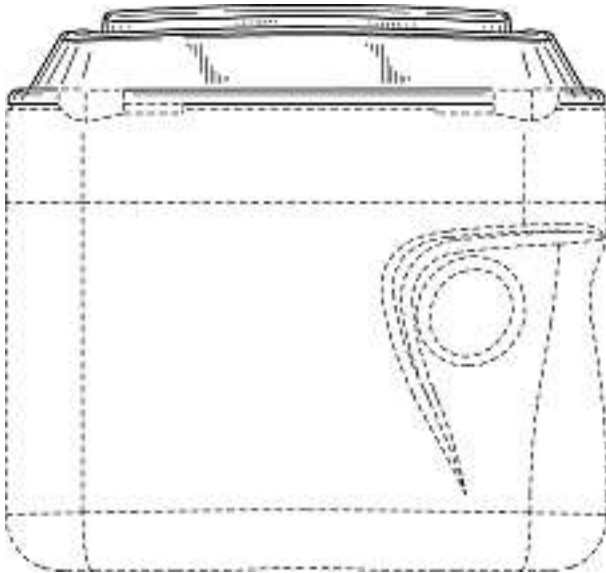
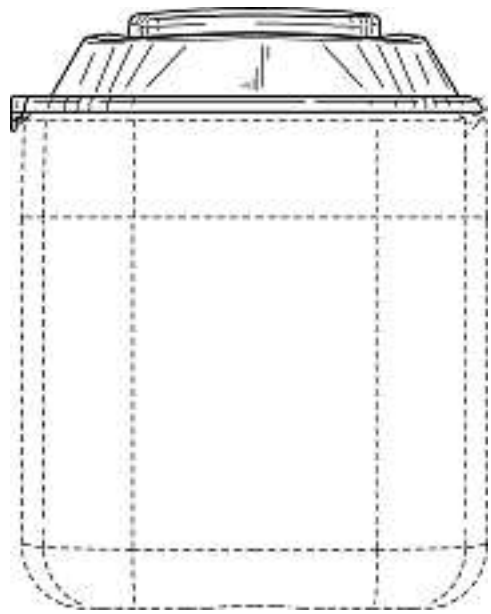
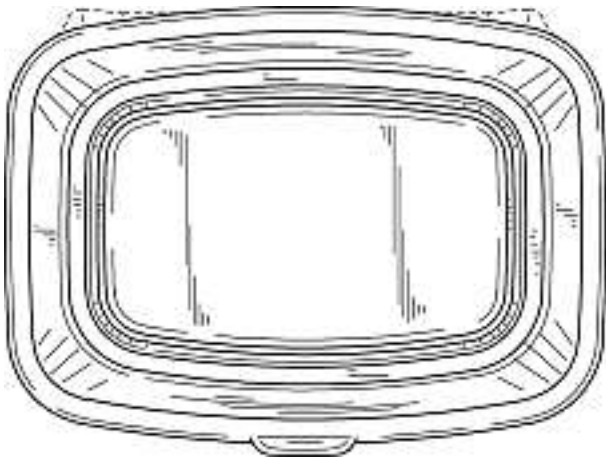

2

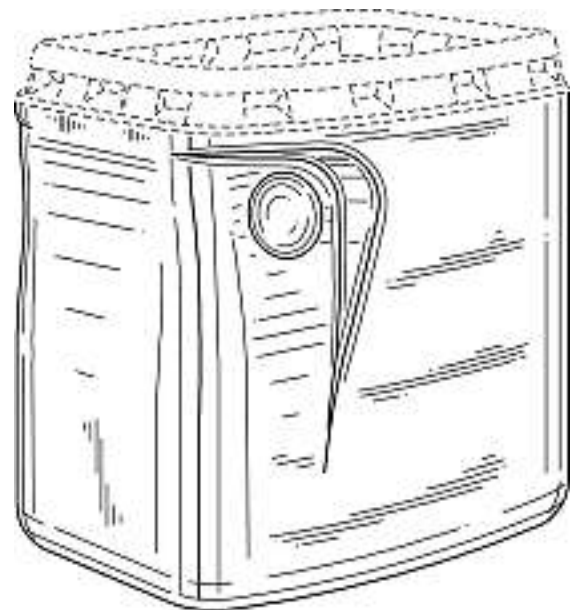
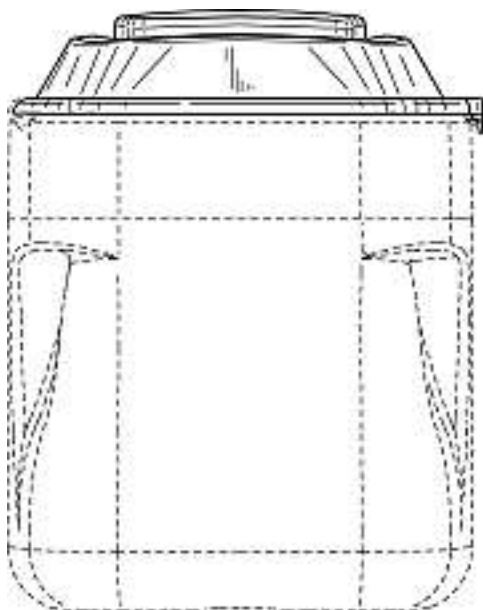
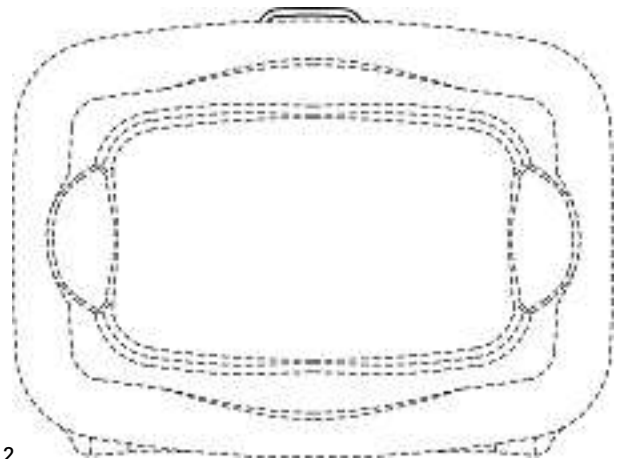

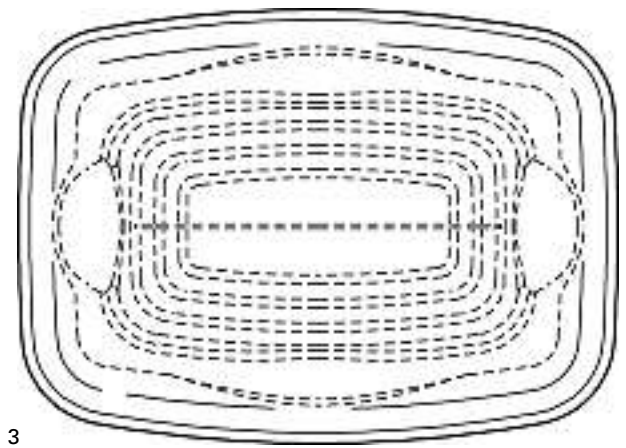
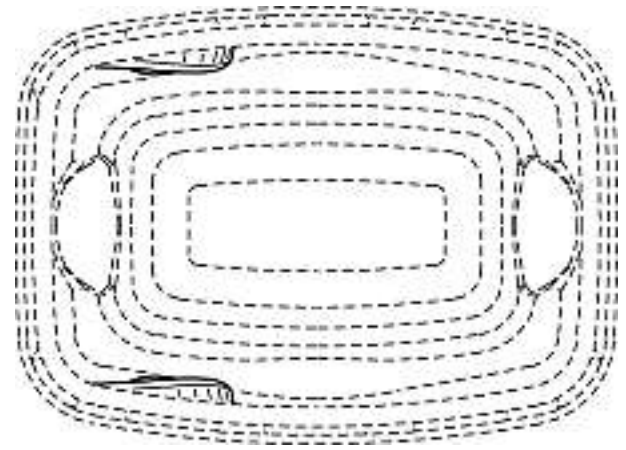

3

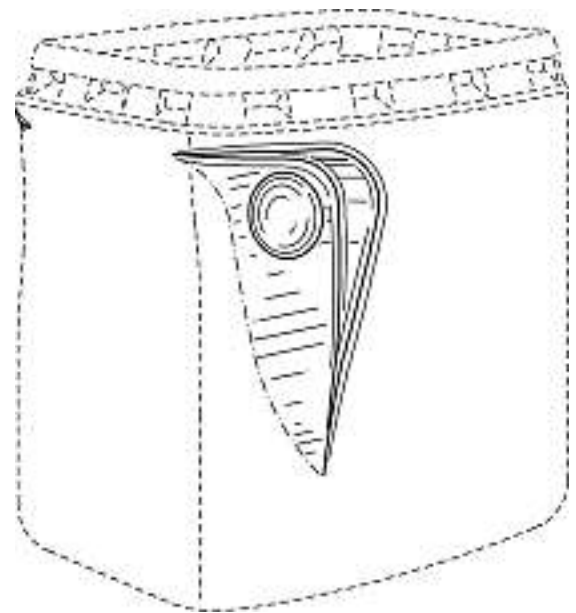
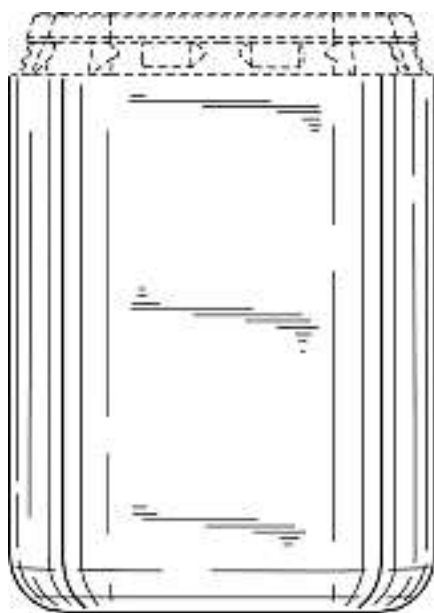

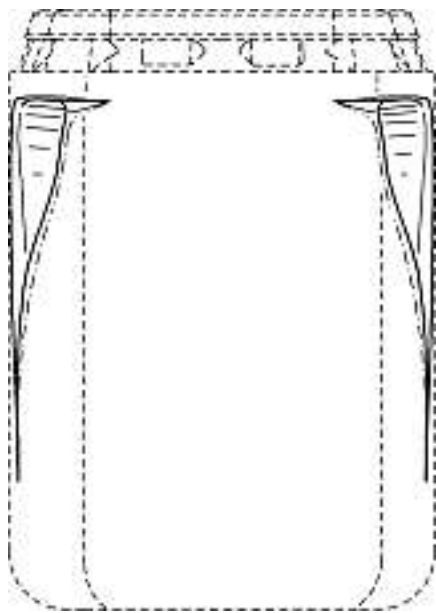
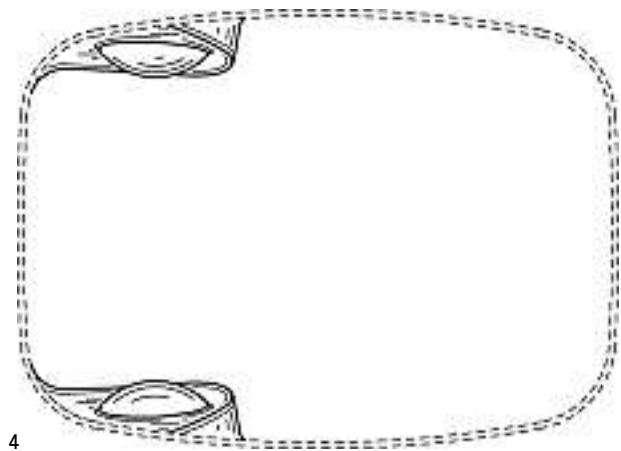
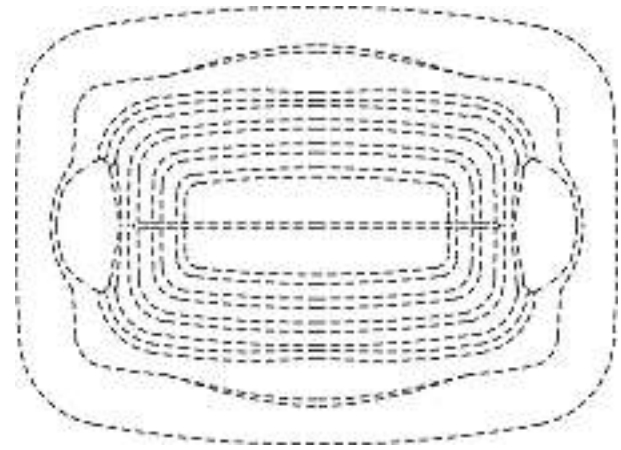
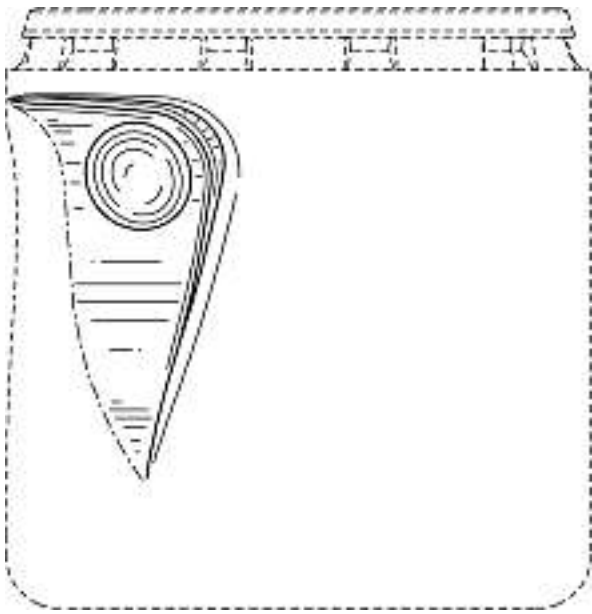

4

Cl. 07-06 **134 994** 06.05.2008  
1 Design – Schraubdeckelöffner  
Hinterleger: Stiftung Brändi, Horwerstrasse 123, 6011 Kriens  
Designer: Michael Hübscher, Basel

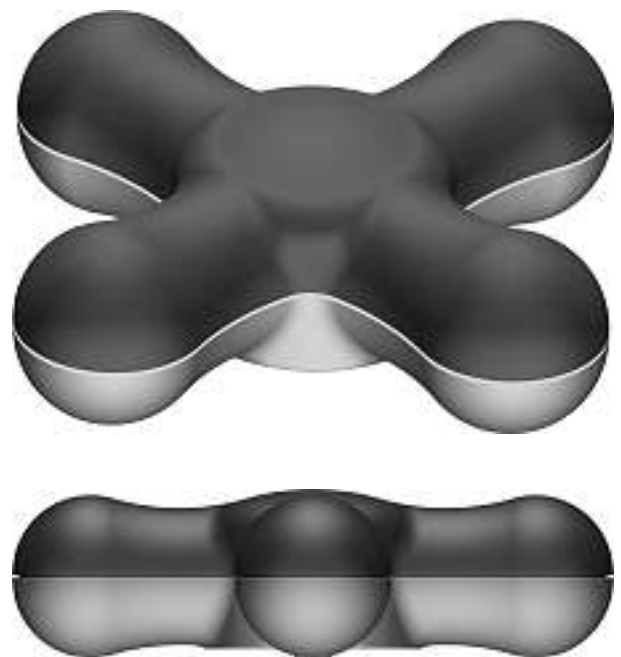
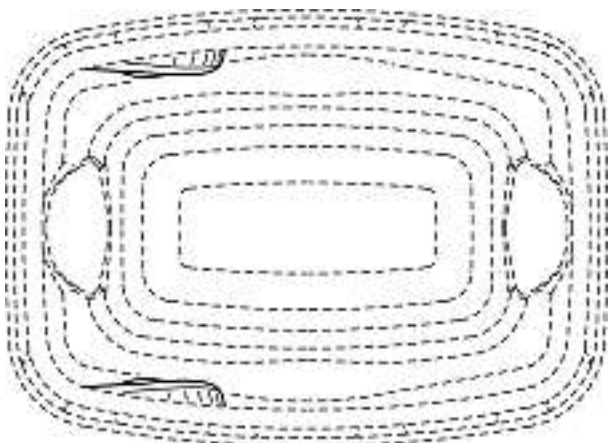



Schraubdeckelöffner

Cl. 07-06 134 995 10.04.2008  
5 Design – Ständer  
Hinterleger: Thomas Franz Wigger, Rishaldenweg 25,  
4852 Rothrist



2



1





3

4





5

Cl. 07-07 **134 996** 14.04.2008  
 1 Design – Eiswürfelbehälter  
 Hinterleger: Dart Industries Inc., 14901 S. Orange Blossom Trail, Orlando / FL, US  
 Designer: Jan-Hendrik de Groot, Haaltert  
 Vertreter: BOHEST AG, 4003 Basel  
 Priorität: US, 09.11.2007

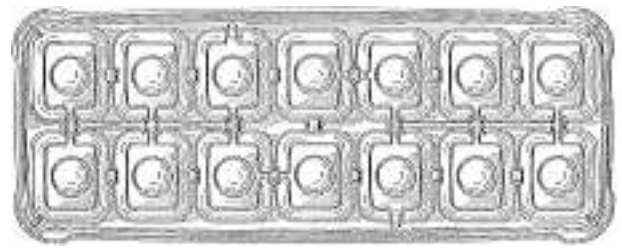
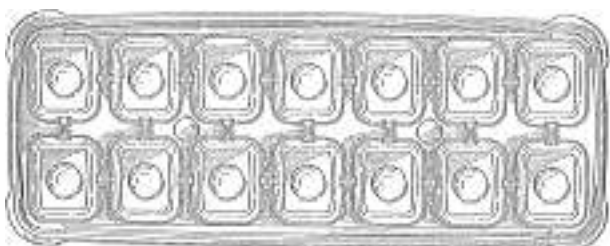
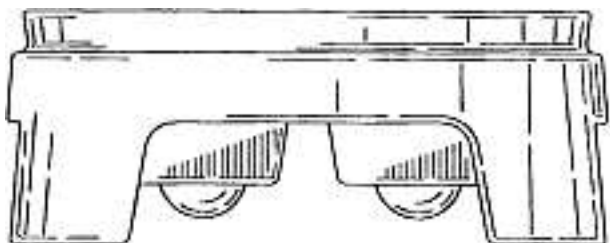
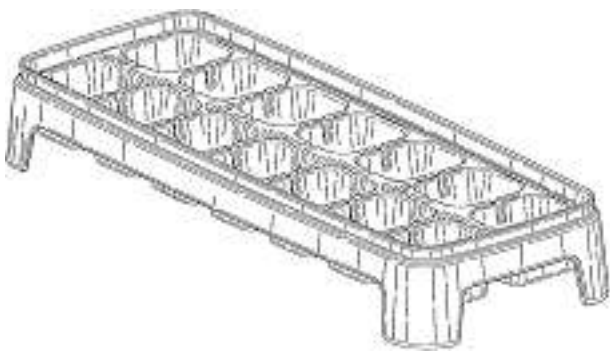

1

Cl. 08-03 **134 997** 09.04.2008  
 1 Design – Messer  
 Hinterleger: Michael Graf, Eigermatte 46, 3110 Münsingen



Der Graf

Cl. 08-08 **134 998** 11.04.2008  
 5 Design – Befestigungselemente, Dübel  
 Hinterleger: fischerwerke GmbH & Co. KG, Weinhalde 14-18, 72178 Waldachtal, DE  
 Designer: Aaron Daly, Pfalzgrafenweiler  
 Vertreter: Patentanwälte Schaad, Balass, Menzl & Partner AG, 8034 Zürich

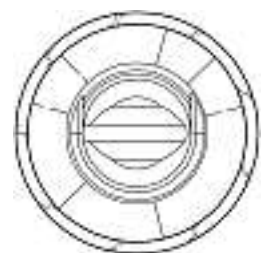
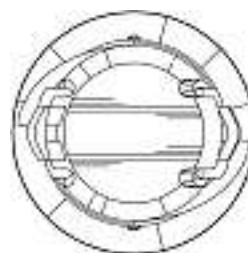
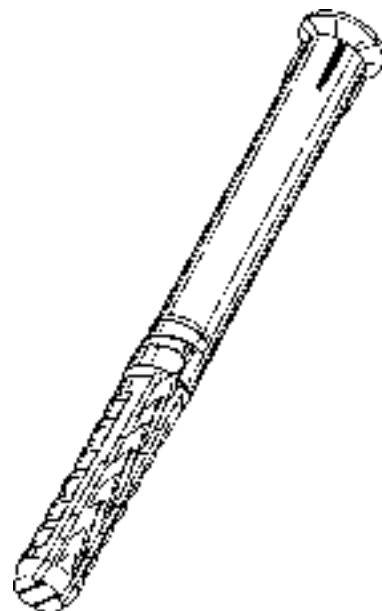

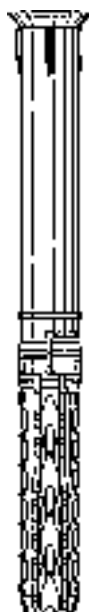
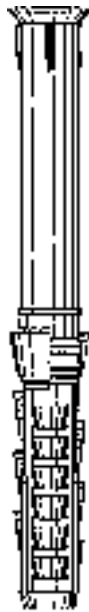
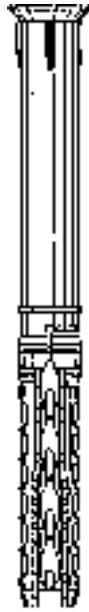

1

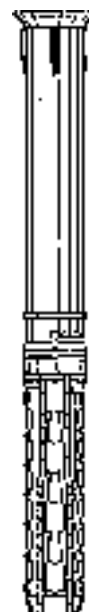
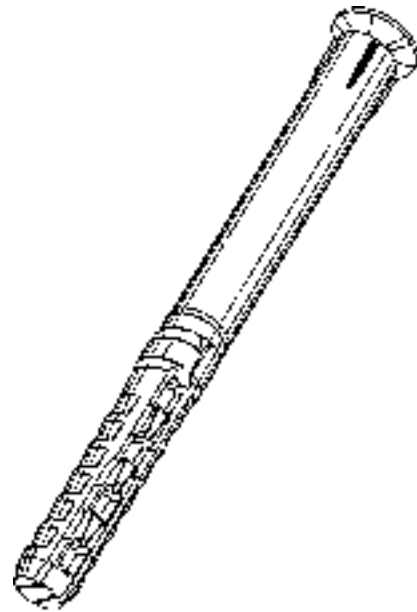



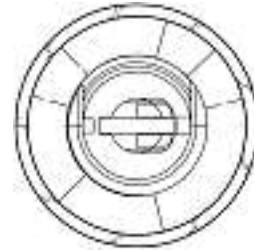
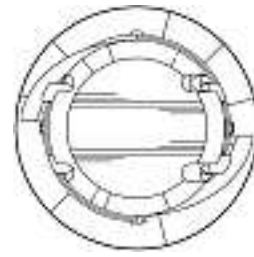
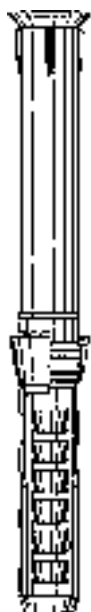
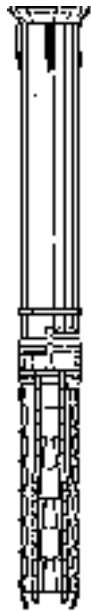
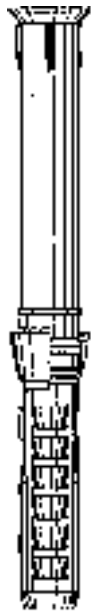

2

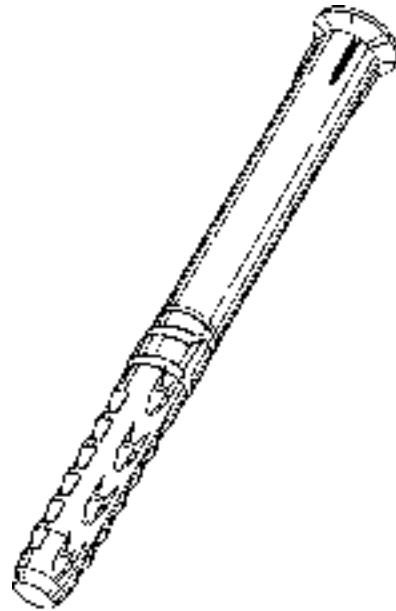

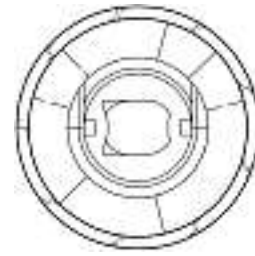
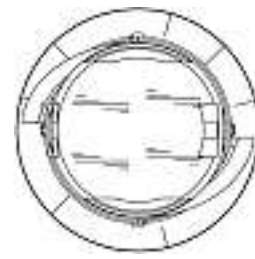
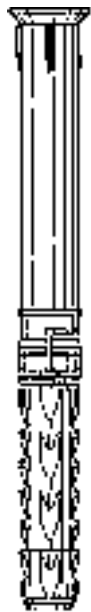

3

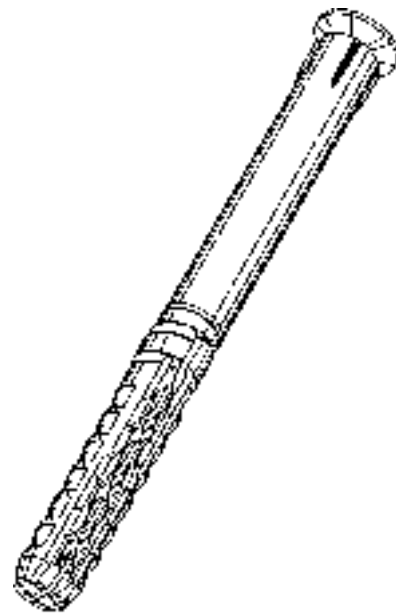

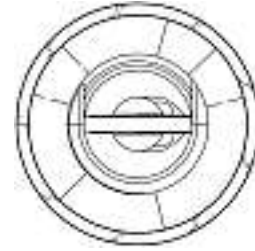
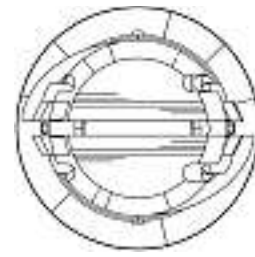
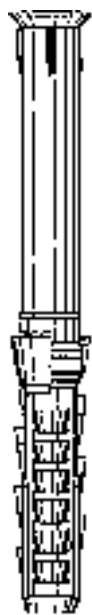
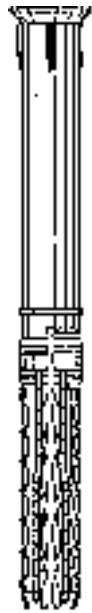
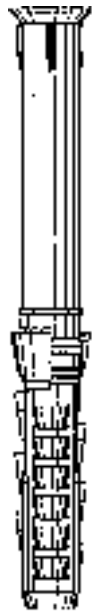

4

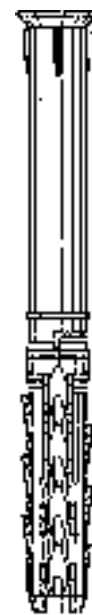
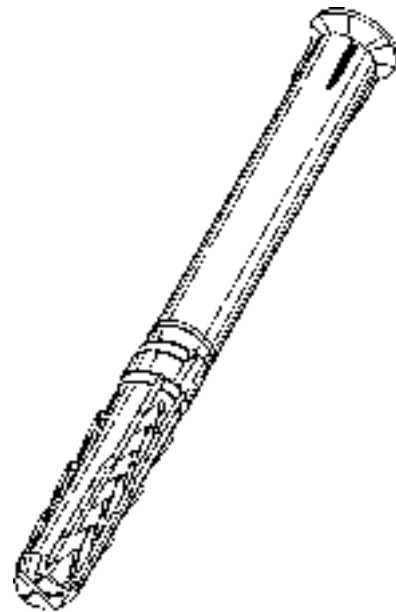

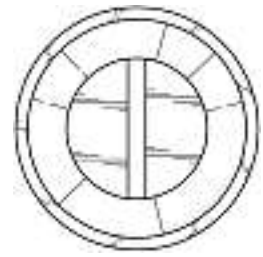
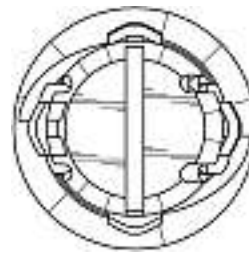
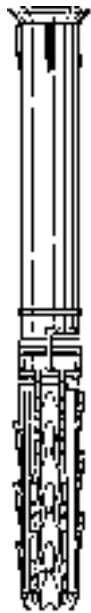

5

Cl. 09-01                      **134 999**                      01.04.2008  
2 Design – Flaschen  
Hinterleger: Unilever N.V., Weena 455, Rotterdam, NL  
Designer: Adrian Barclay Caroen, London; Tanja Ingrid  
Langgner, London  
Vertreter: E. Blum & Co. AG, Patent- und Markenanwälte VSP,  
8044 Zürich  
Priorität: GB, 18.10.2007

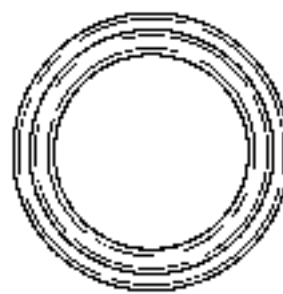
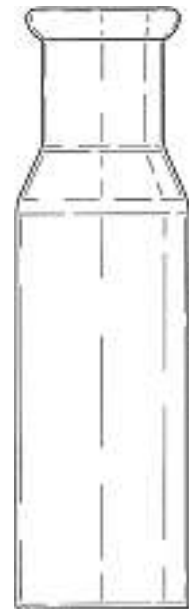

1

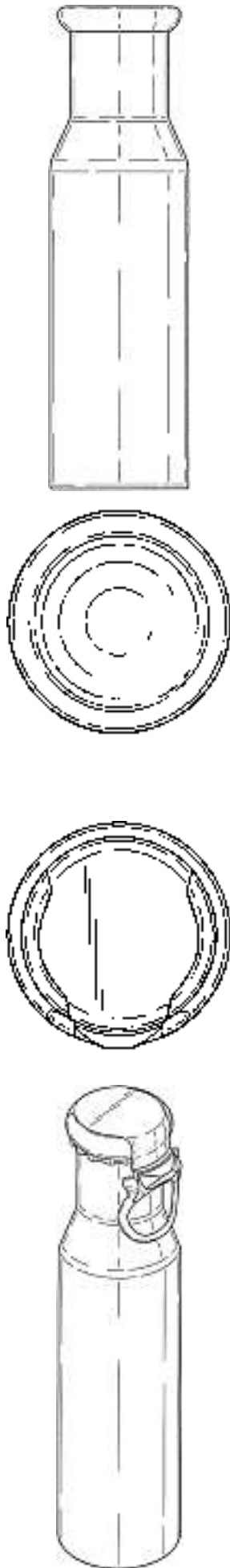

2

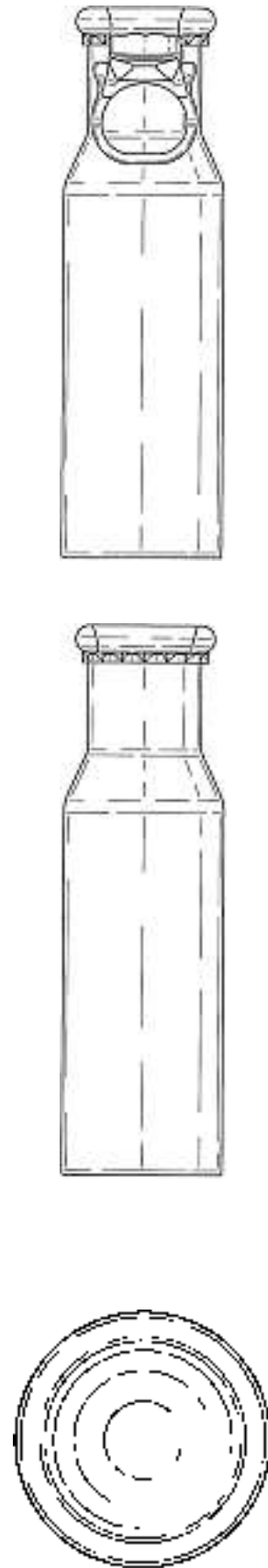

Cl. 09-01 135 000 08.04.2008  
1 Design – Flasche  
Hinterleger: Fehba Import Export AG, Wiesenstrasse 8,  
8196 Wil ZH  
Designer: Felix Angst, Wil; Balz Dubs, Wil



Hantelflasche

FL 72172

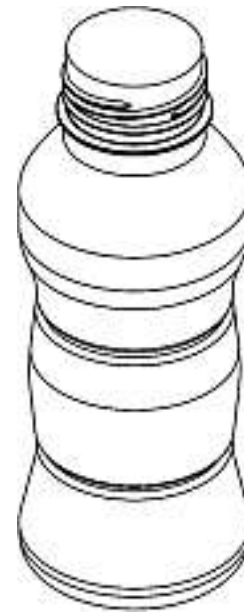

Cl. 09-01 **135 002** 05.05.2008  
 1 design – bouteille  
 Déposant: Société des Produits Nestlé SA, 1800 Vevey  
 Designer: Frédéric Broxolle, Octeville sur Mer  
 Mandataire: Nestec S.A., 1800 Vevey

Cl. 09-03 **135 004** 25.03.2008  
 3 design – conteneurs  
 Déposant: LRC Products Limited, 35 New Bridge Street,  
 London EC4V 6BW, GB  
 Designer: Sarah Ann Sage, Windsor  
 Mandataire: Kirker & Cie S.A., Ingénieurs-Conseils,  
 1226 Genève - Thônex  
 Priorité: EM, 26.09.2007

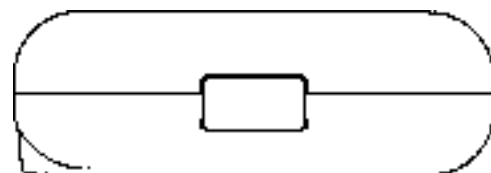
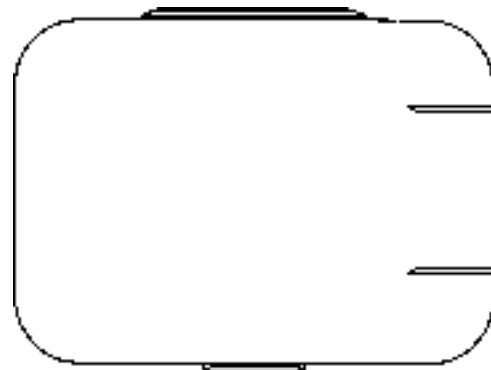
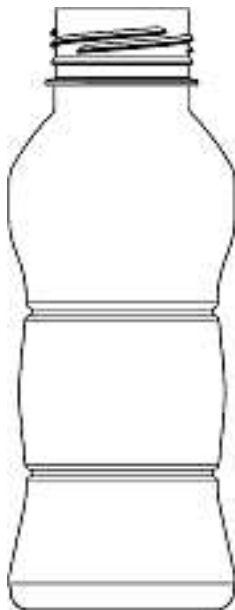

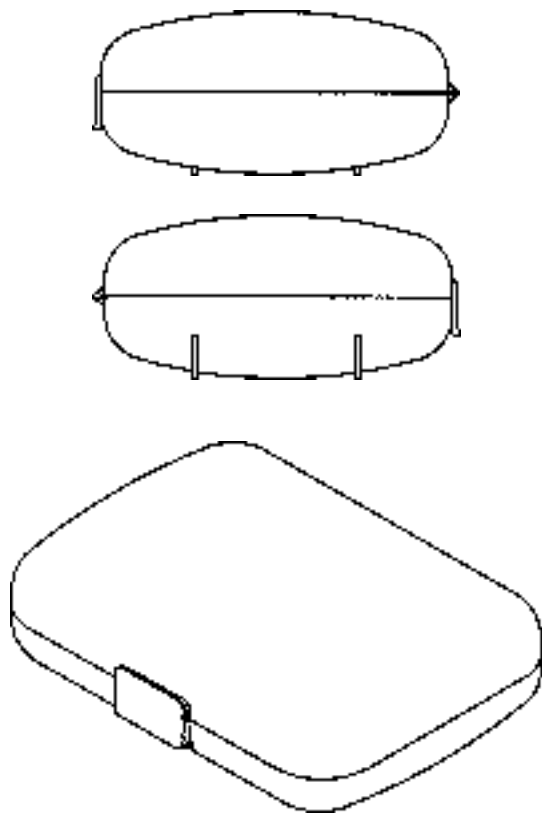

1

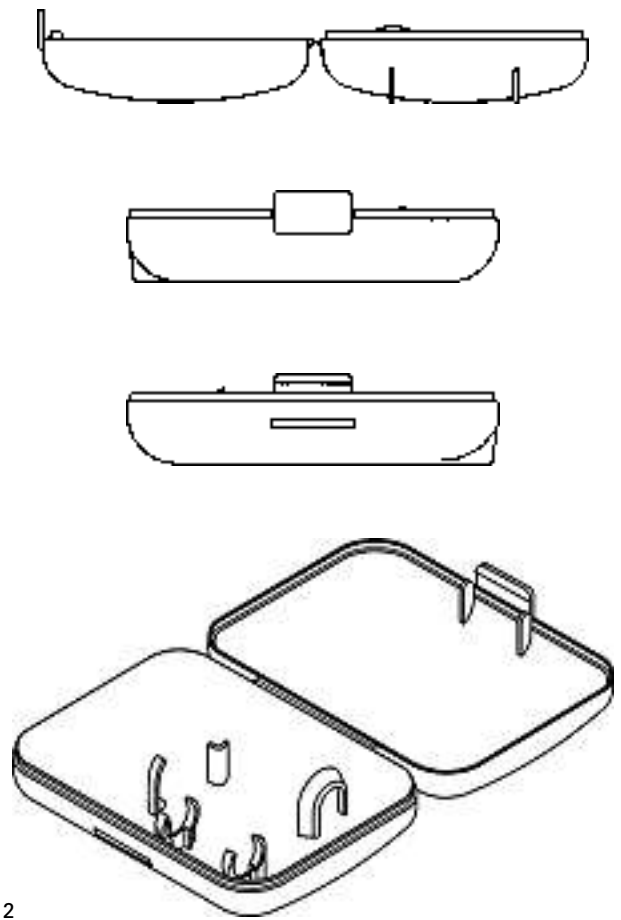
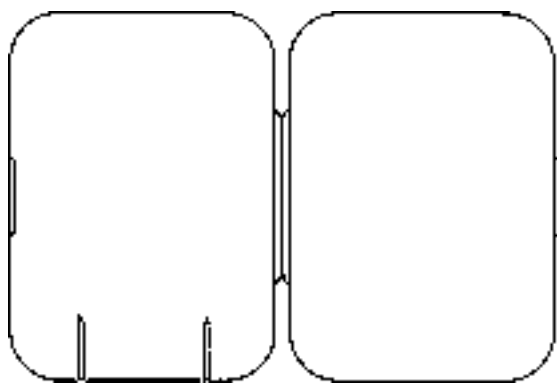
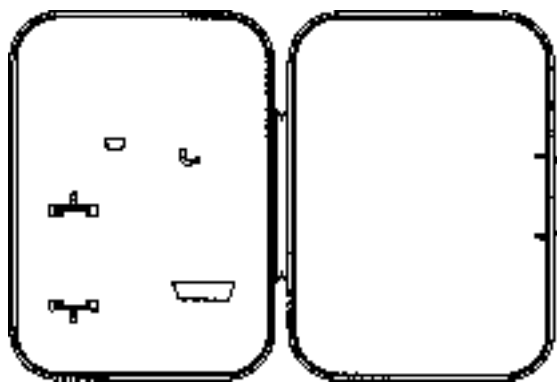

2

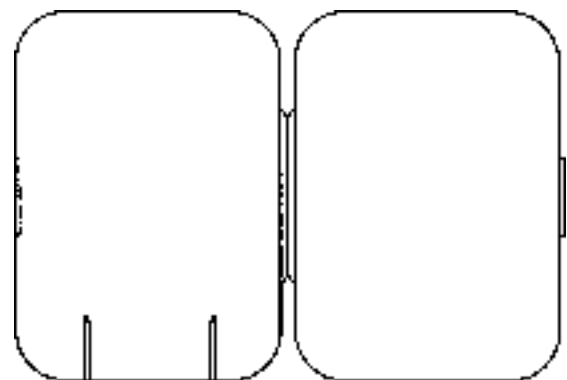
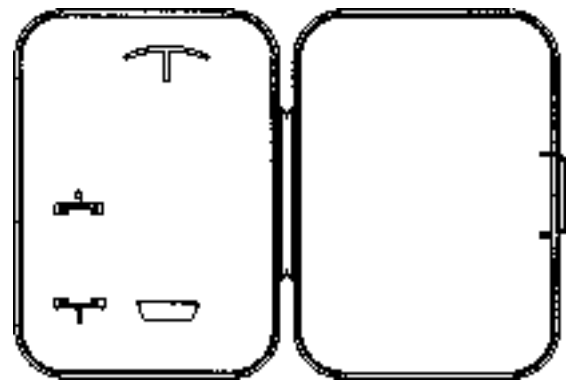

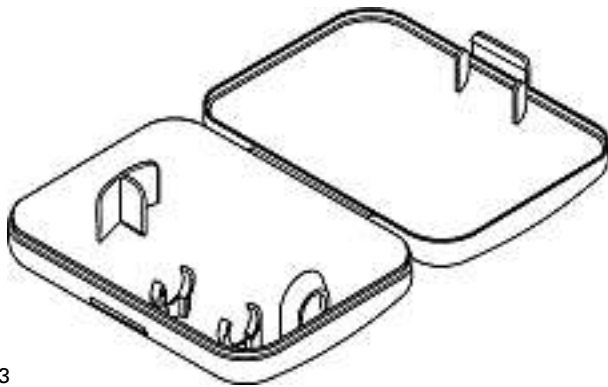
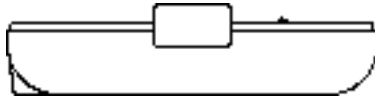
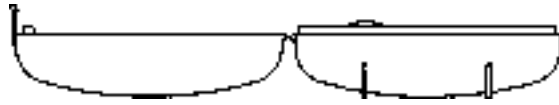

3

Cl. 10-02                      **135 005**                      27.03.2008  
 5 design – montres-bracelets  
 Déposant: TechnoMarine SA, Rue de la Rôtisserie 2,  
 1204 Genève  
 Designer: Thanas Lipe, Neuchâtel  
 Mandataire: Inteltech SA, 2001 Neuchâtel



1





2





3



4



5



Cl. 10-02 **135 006** 01.04.2008  
 1 design – montre-bracelet  
 Déposant: Chitra Subramaniam-Duella, Chemin de la Dôle 1,  
 1196 Gland; Marc Aeschbacher, 3 Grand Rue, 1183 Bursins  
 Designer: Eddy Burgener, Le Landeron  
 Mandataire: Chitra Subramaniam-Duella, 1196 Gland



B01A

Cl. 10-02 **135 007** 02.04.2008  
 3 design – montres, chronographe  
 Déposant: Cyma S.A., 26, Billodes, 2400 Le Locle  
 Designer: Jean-Marie Girardin, Les Brenets; Christian  
 Glauser, Cortaillod  
 Mandataire: Soprintel S.A., 2300 La Chaux-de-Fonds



1 New Signature

Cl. 10-02 135 008 03.04.2008  
1 design – montre-bracelet  
Déposant: The British Masters SA, Avenue Léopold-Robert 23,  
2300 La Chaux-de-Fonds  
Designer: Eric A. Loth, La Chaux-de-Fonds  
Mandataire: Inteltech SA, 2001 Neuchâtel



2 Navy Star



3 Navy Star





154400/010021



Cl. 10-02                      **135 009**                      04.04.2008  
 1 design – montre-bracelet  
 Déposant: Bédât & Co SA, 45, rue Agasse, 1208 Genève  
 Designer: Dino Modolo, La Chaux-de-Fonds  
 Mandataire: Inteltech SA, 2001 Neuchâtel



1



Cl. 10-02                      **135 010**                      04.04.2008  
5 design – montres-bracelets  
Déposant: TechnoMarine SA, Rue de la Rôtisserie 2,  
1204 Genève  
Designer: Thanas Lipe, Neuchâtel  
Mandataire: Inteltech SA, 2001 Neuchâtel



1





3



4



2



5



Cl. 10-04 135 012 21.03.2008  
 1 Design – Gehäuse für Messgerät  
 Hinterleger: Christian Mangold, Schützenstrasse 30,  
 8304 Wallisellen

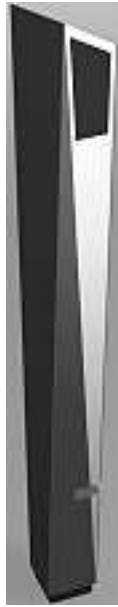

Cl. 10-07 135 013 28.03.2008  
 6 design – montres  
 Déposant: Bell & Ross B.V., Boerhaavelaan 22,  
 2713 HX Zoetermeer, NL  
 Designer: Bruno Belamich, Paris  
 Mandataire: ANDRE ROLAND S.A., 1001 Lausanne  
 Priorité: EM, 26.03.2008

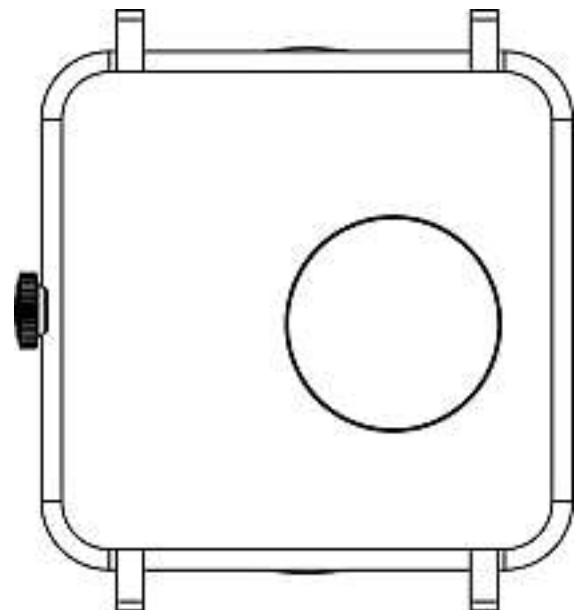
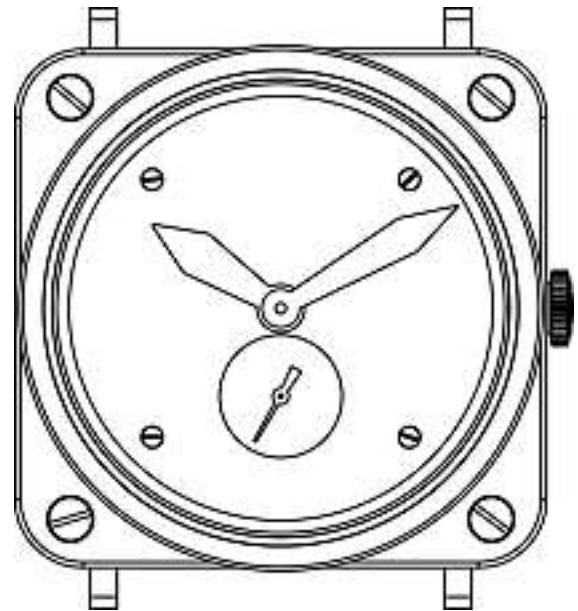
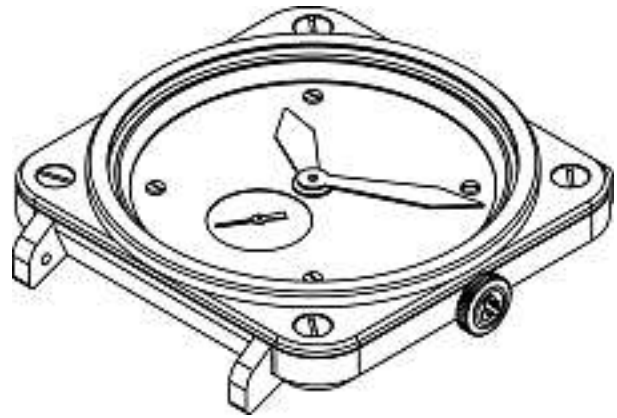



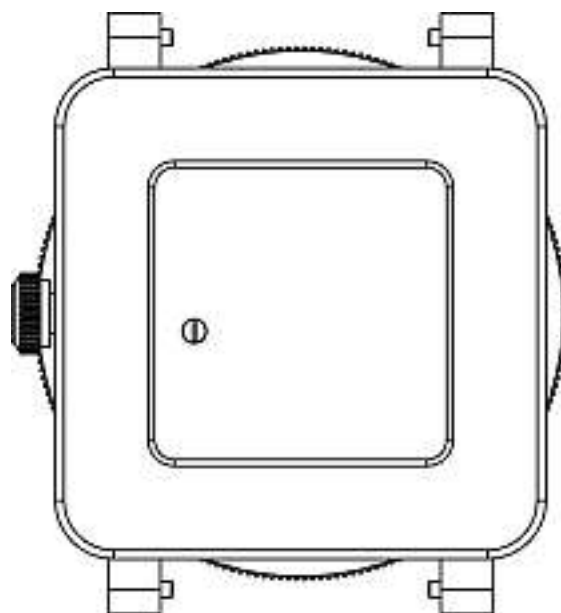
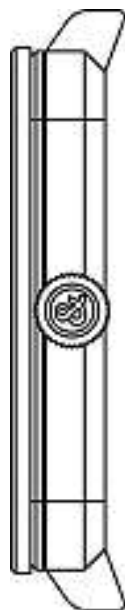
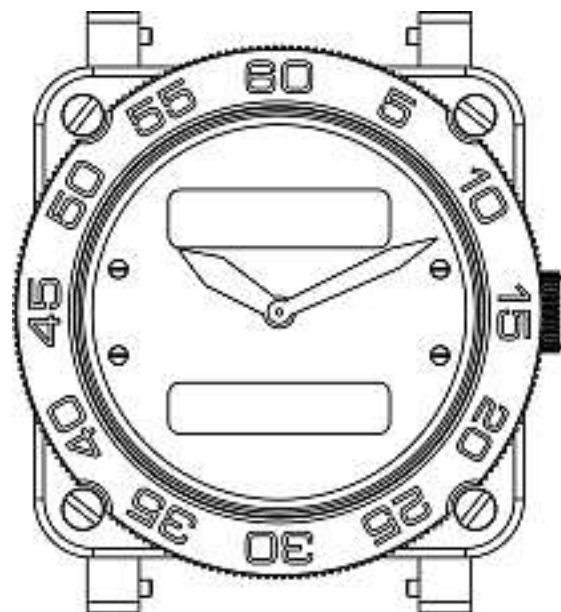
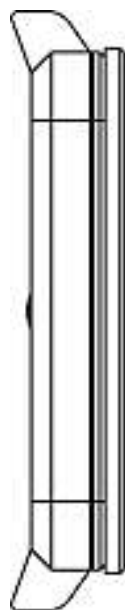

0019-031.D.CH-1

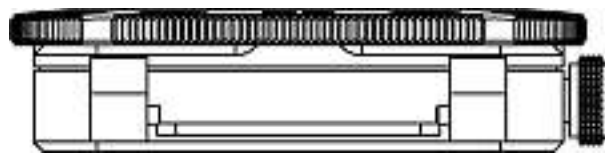
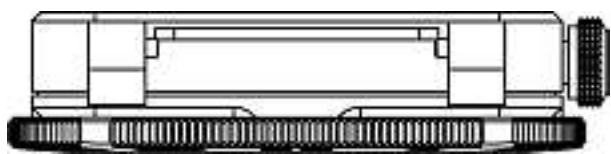

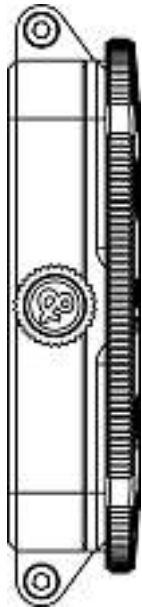
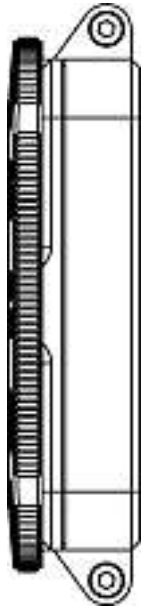

0019-031.D.CH-2

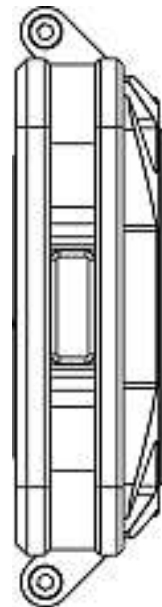
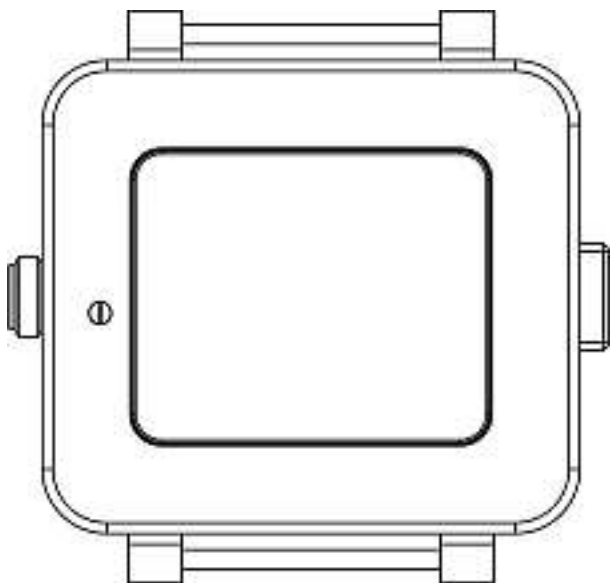
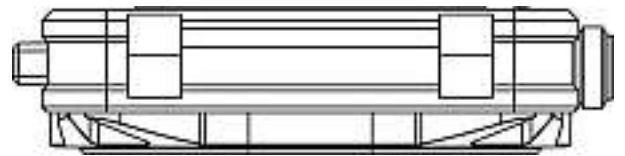
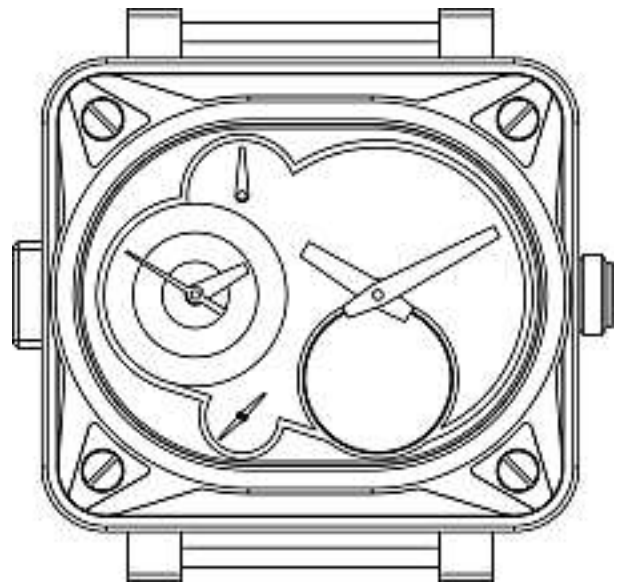
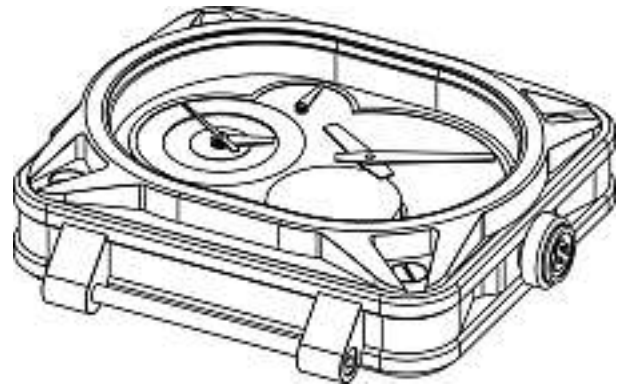

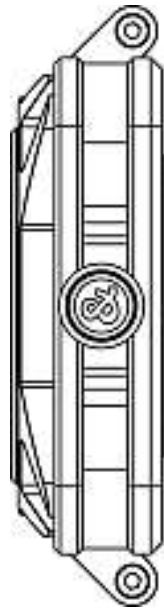
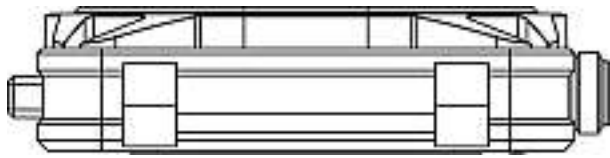

0019-031.D.CH-3

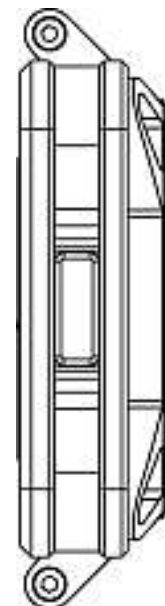
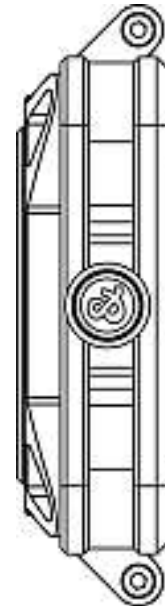
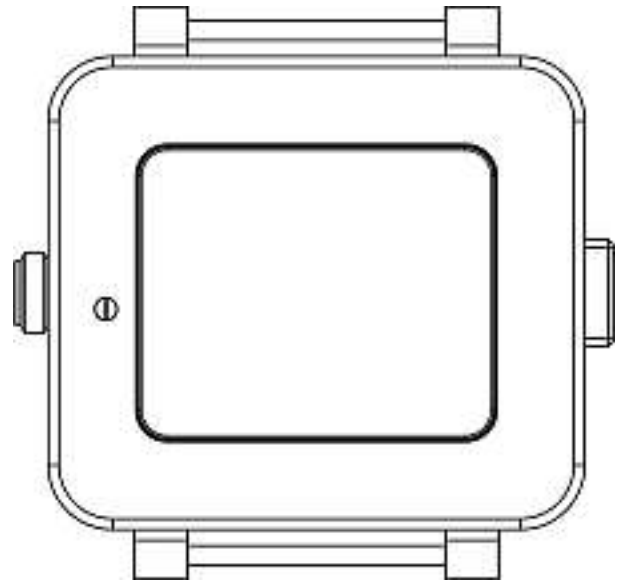
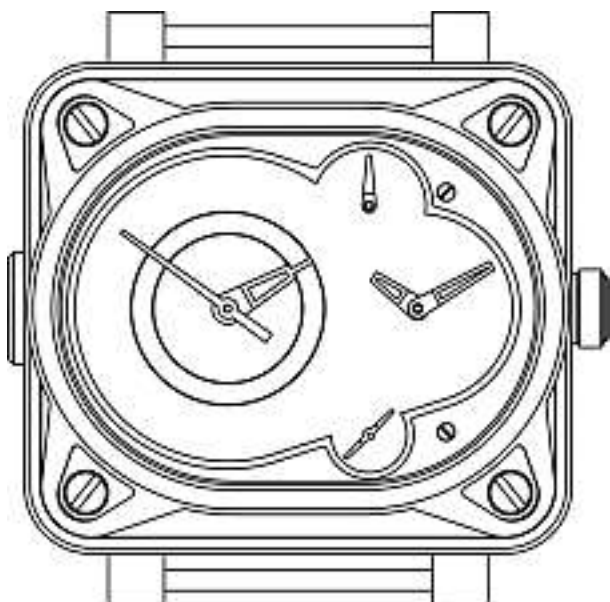

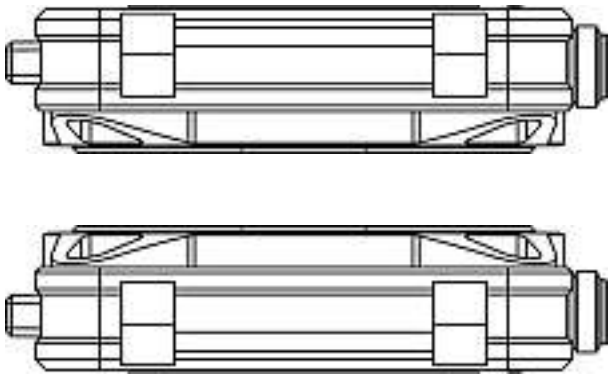

0019-031.D.CH-4

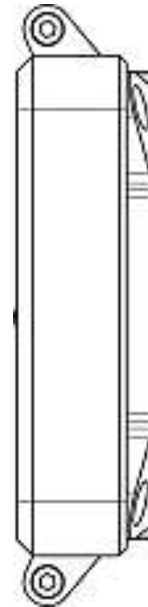
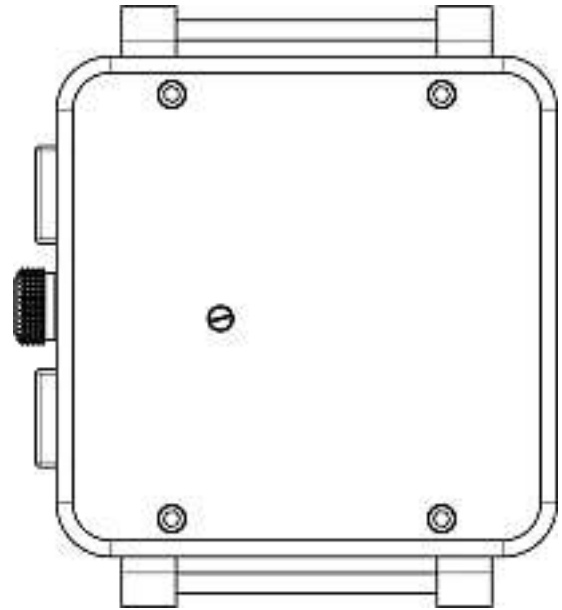
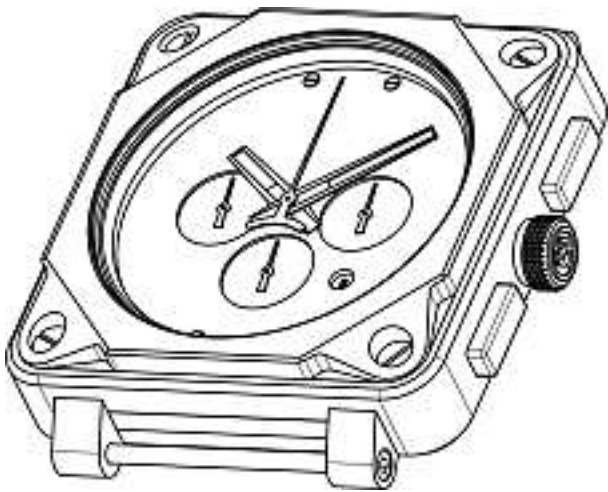



0019-031.D.CH-5

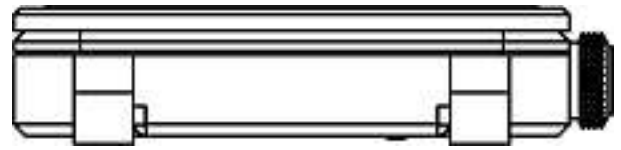
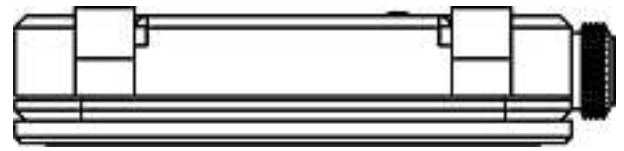
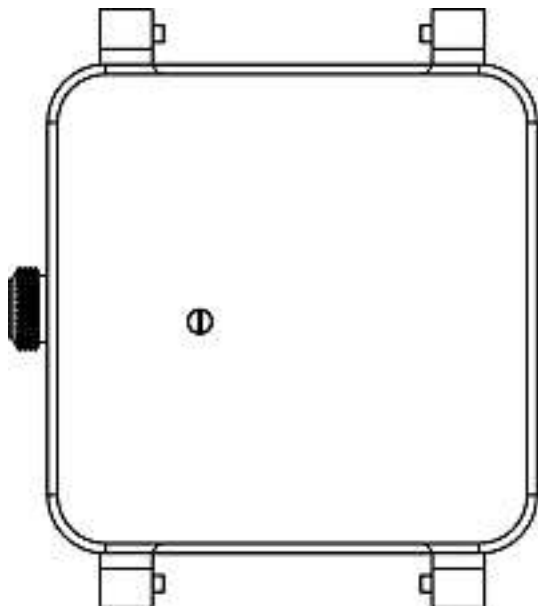
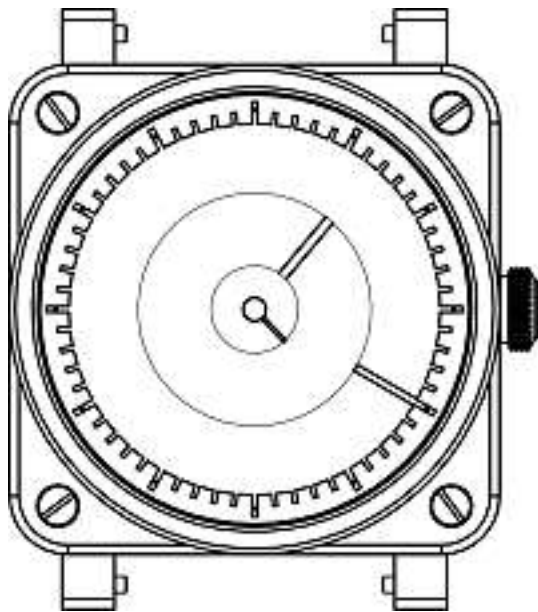
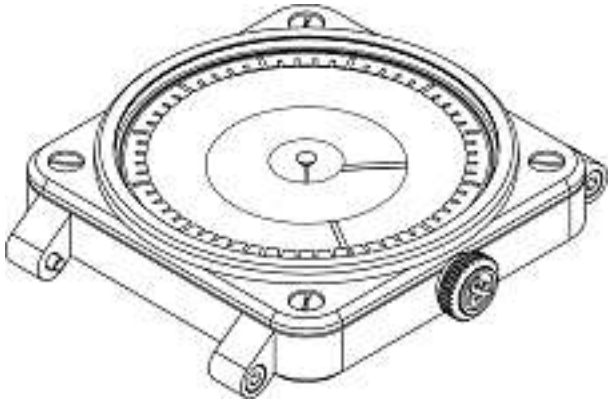

0019-031.D.CH-6

Cl. 10-07 **135 014** 31.03.2008  
 4 design – cadrans de montre  
 Déposant: Raymond Weil SA, 36-38, avenue Eugène-Lance,  
 1212 Grand-Lancy  
 Designer: Sébastien Actis-Datta, Villars-Tiercelin  
 Mandataire: Soprintel S.A., 2300 La Chaux-de-Fonds

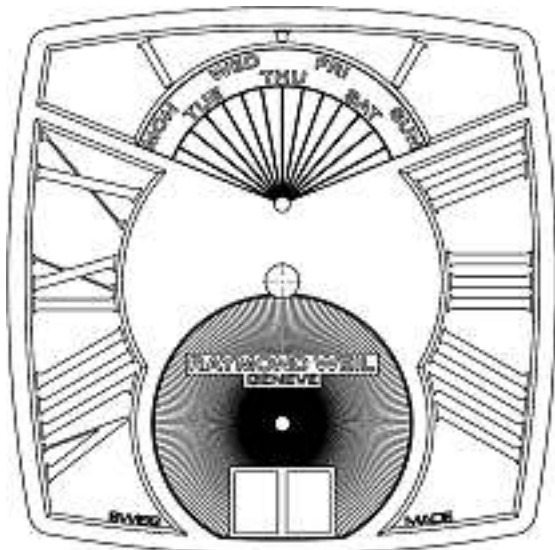

1

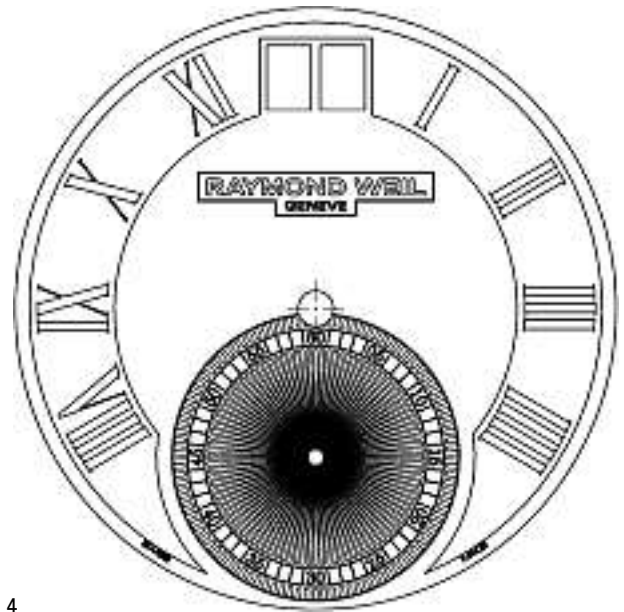

4

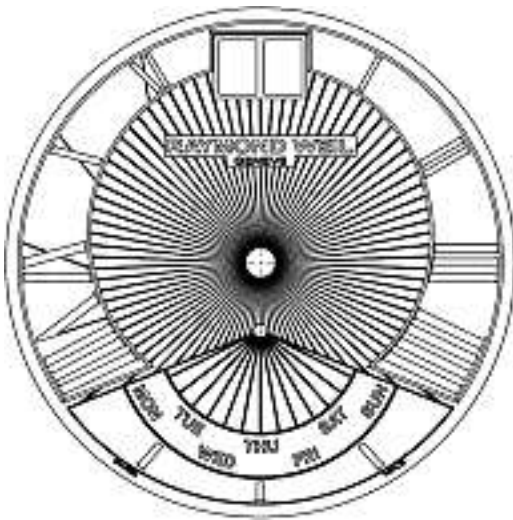

2

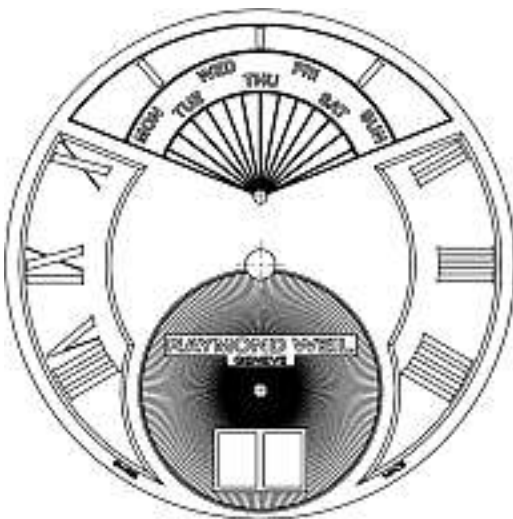

3

Cl. 10-07 135 015 02.04.2008  
 2 design – boîtes de montres  
 Déposant: Vincent Plomb, Rue du Stade 1, 2926 Boncourt

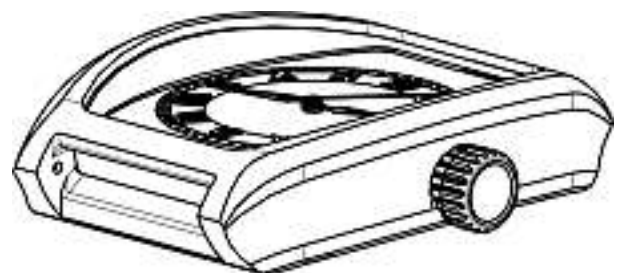
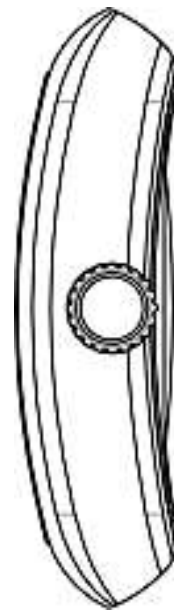
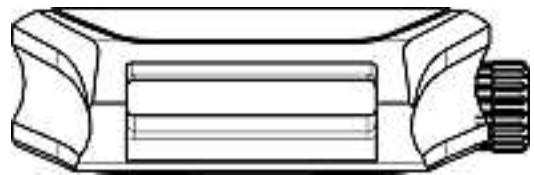

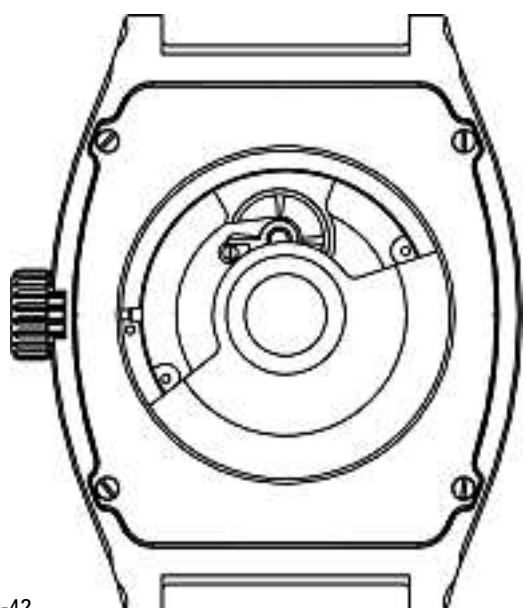
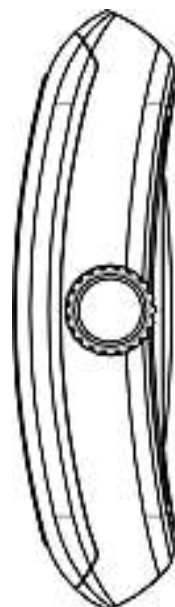
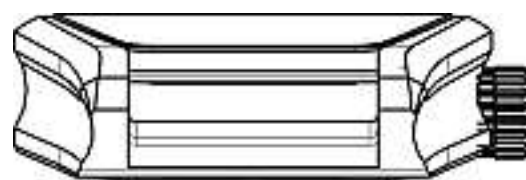

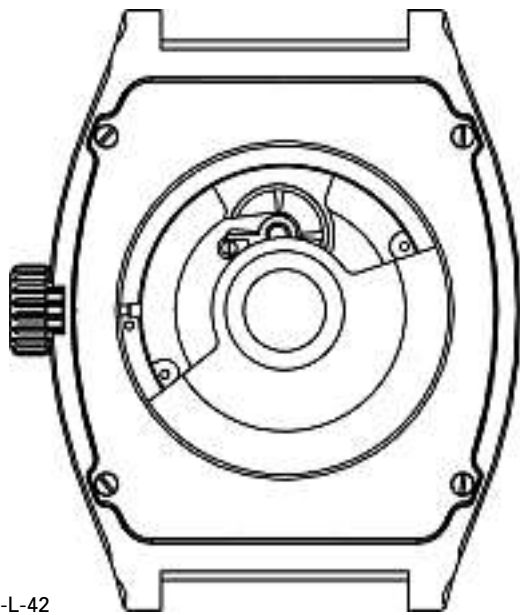
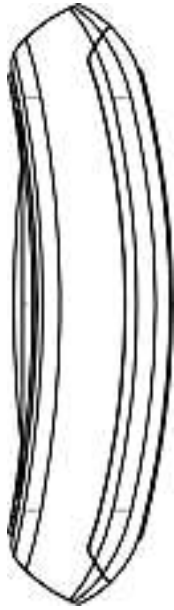

B-15-L-42



1



2

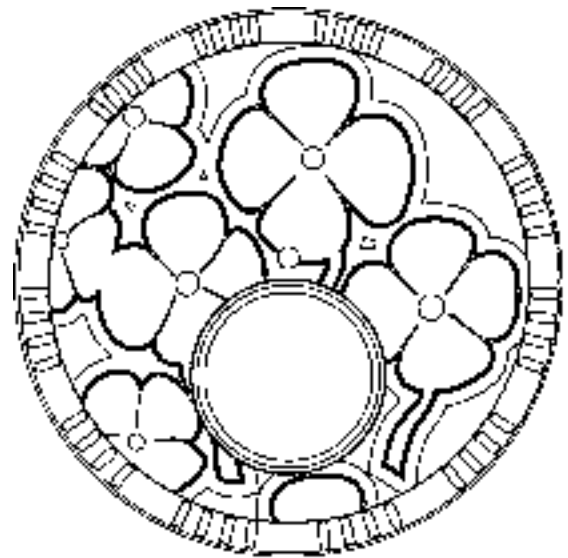

3

Cl. 10-07 135 016 07.04.2008  
 12 design – cadrans de montre  
 Déposant: Les Développements Horlogers (LDH), c/o TVA  
 Conseils Stéphane Gmünder, Boulevard Pérolles, 8,  
 1700 Fribourg  
 Designer: Carlos Dias, Carouge  
 Mandataire: Moinas & Savoye S.A., 1201 Genève





4

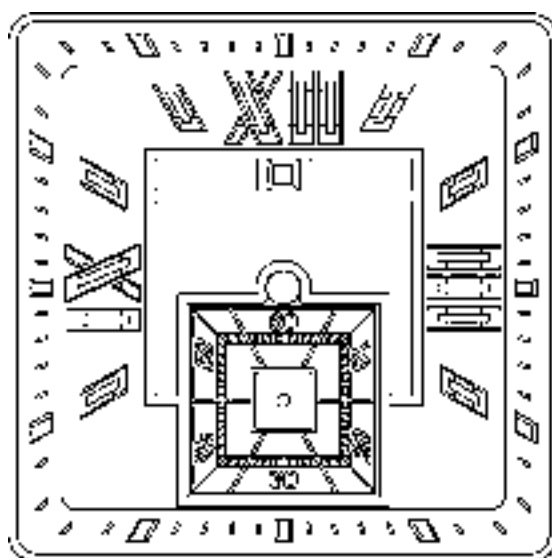

7

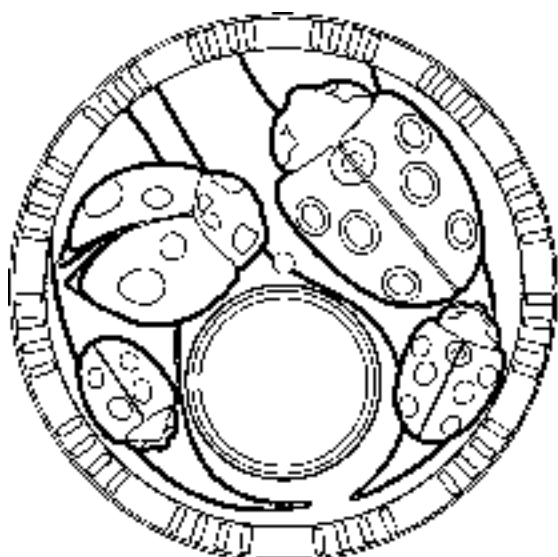

5

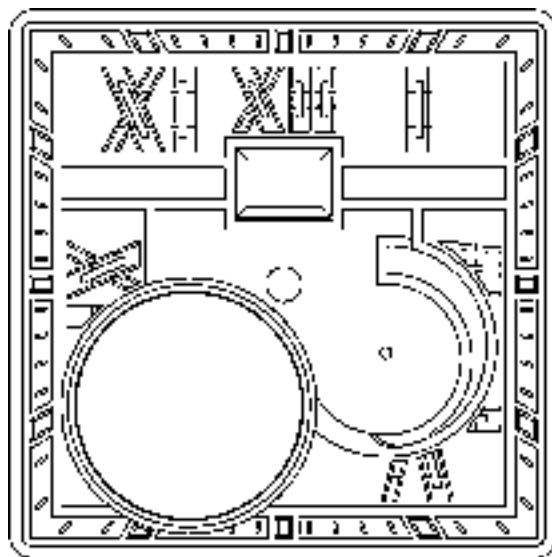

8

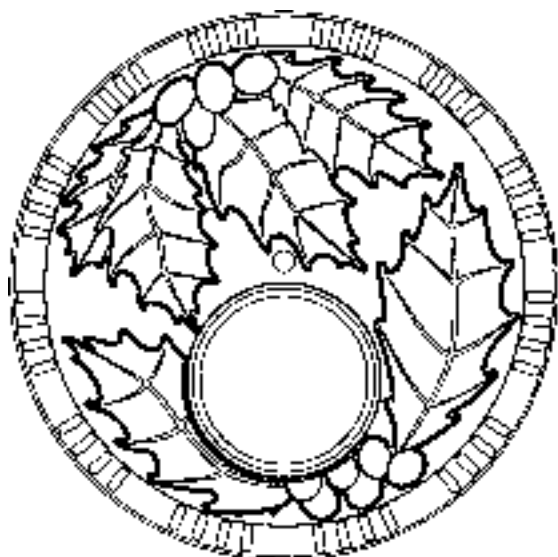

6

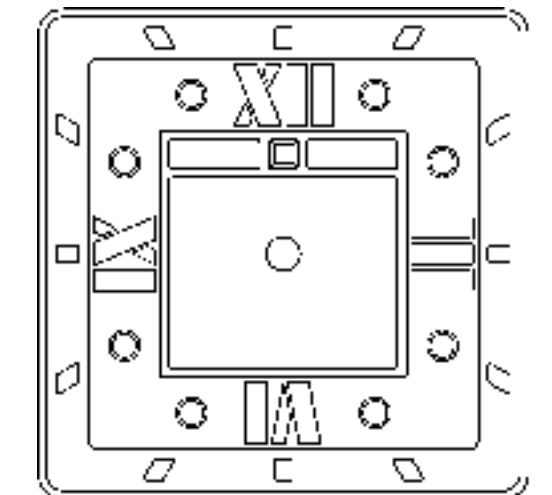

9

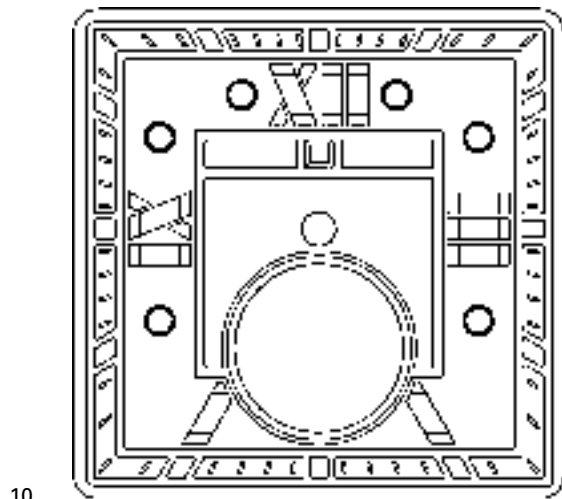

10

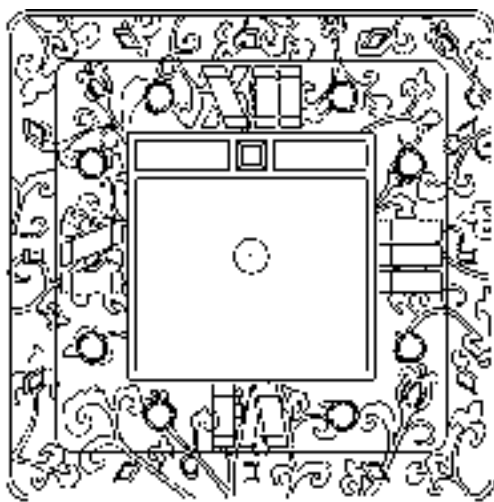

11

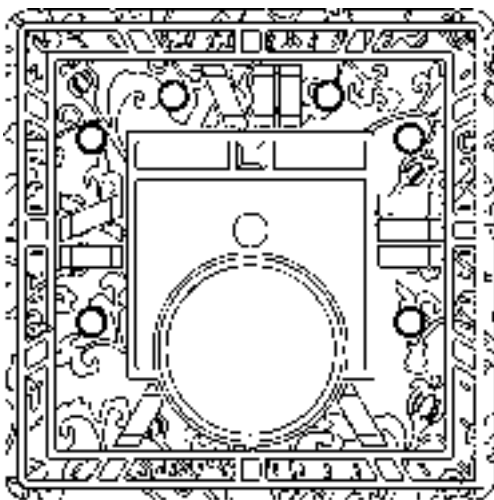

12

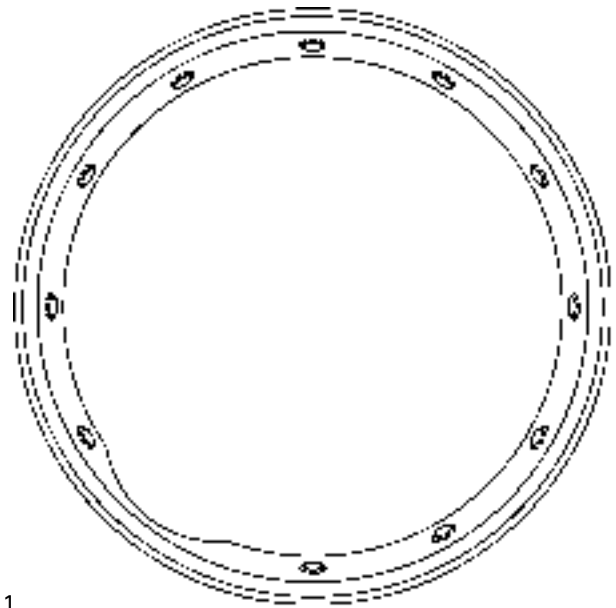

1

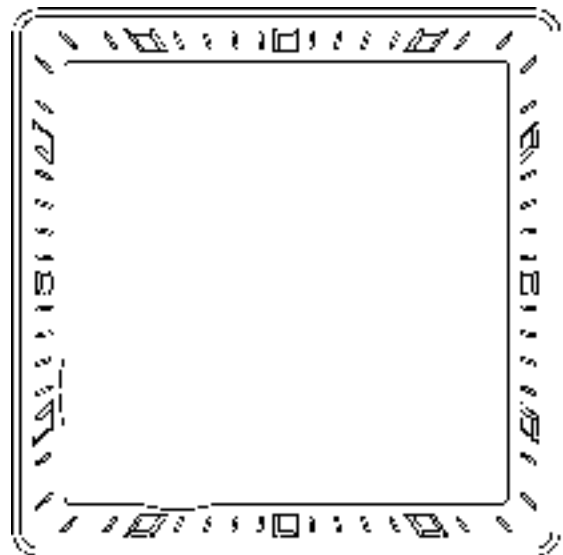

2

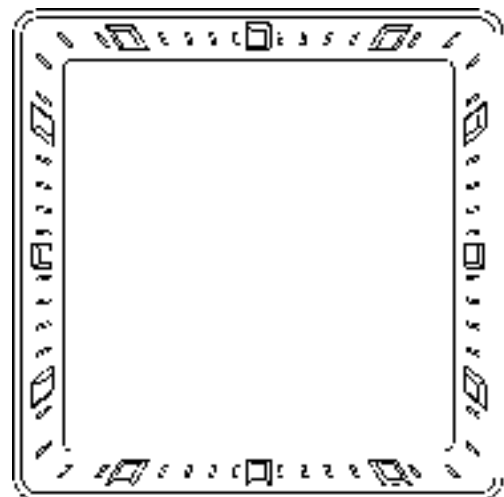

3

Cl. 10-07 135 017 07.04.2008  
 3 design – réhaut pour montre  
 Déposant: Les Développements Horlogers (LDH), c/o TVA  
 Conseils Stéphane Gmünder, Boulevard Pérolles, 8,  
 1700 Fribourg  
 Designer: Carlos Dias, Carouge  
 Mandataire: Moinas & Savoye S.A., 1201 Genève

Cl. 10-07 135 018 07.04.2008  
 3 design – mouvements montres squelettes  
 Dépositant: Les Développements Horlogers (LDH), c/o TVA  
 Conseils Stéphane Gmünder, Boulevard Pérolles, 8,  
 1700 Fribourg  
 Designer: Carlos Dias, Carouge  
 Mandataire: Moinas & Savoye S.A., 1201 Genève

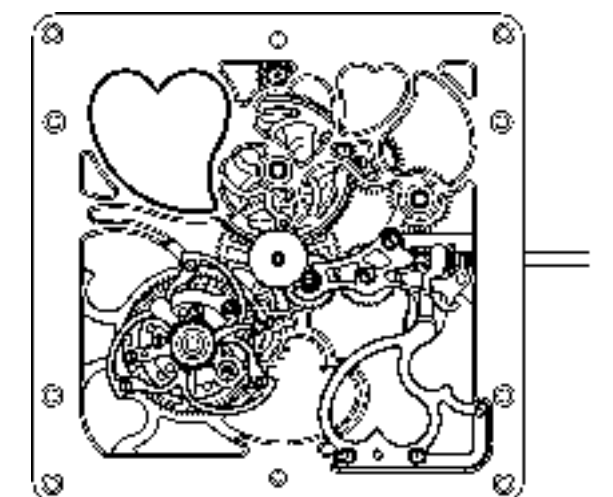
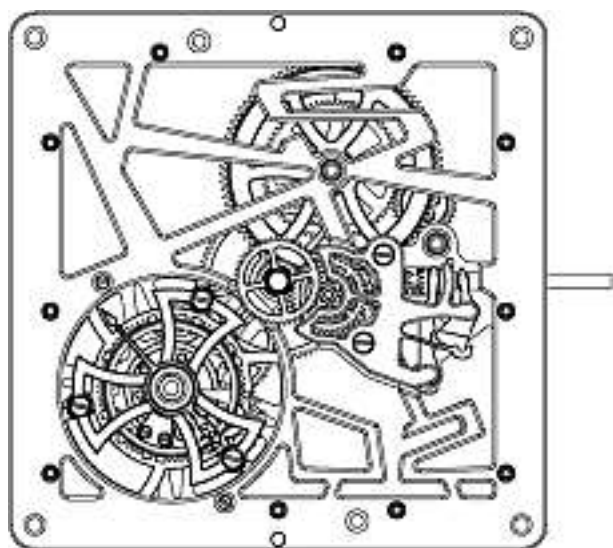
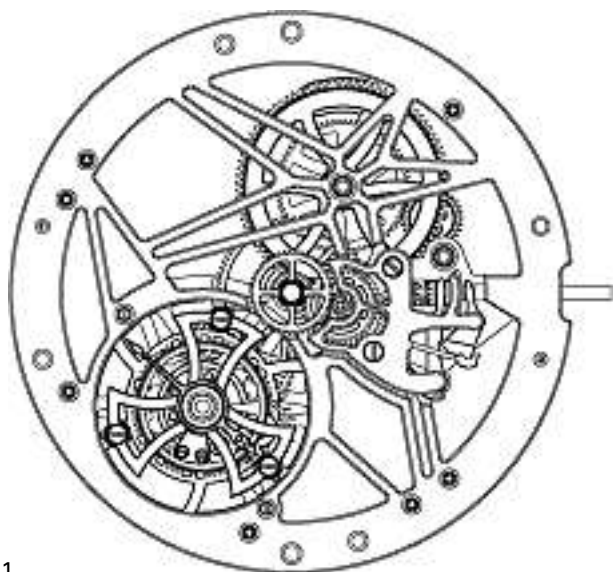

Cl. 11-01 135 019 31.03.2008  
 1 Design – Schmuck  
 Hinterleger: Eva Müller, im Geissacker 61, 8404 Winterthur



eigenArt

Cl. 11-01 135 020 01.04.2008  
 3 design – bague, pendentif, boucle d'oreilles  
 Dépositant: Boghossian SA, Rue Guillaume-Tell 10,  
 1201 Genève  
 Designer: Ralph Boghossian, Genève  
 Mandataire: Bugnion S.A., 1211 Genève 12 - Champel

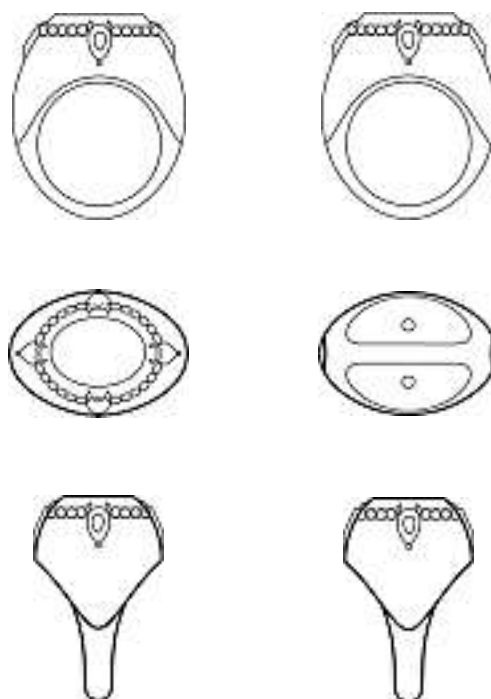

1



2

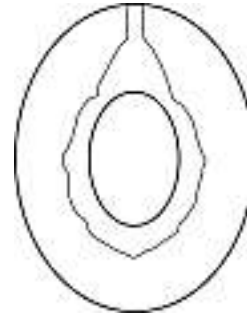
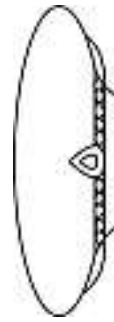
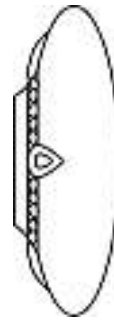
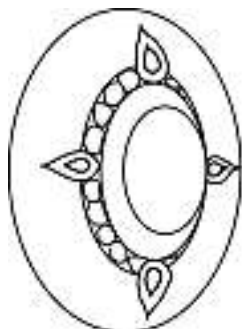

3

Cl. 11-01 135 021 02.04.2008  
17 design – bagues, bracelets, boucles d'oreilles et pendentifs  
Déposant: de Grisogono S.A., 176bis, Route de Saint-Julien,  
1228 Plan-les-Ouates  
Designer: Fawaz Gruosi, Prangins





D-CH-573-08-01





D-CH-573-08-021



D-CH-573-08-022



D-CH-573-08-031



D-CH-573-08-032







D-CH-573-08-04





D-CH-573-08-05





D-CH-573-08-06



D-CH-573-08-07



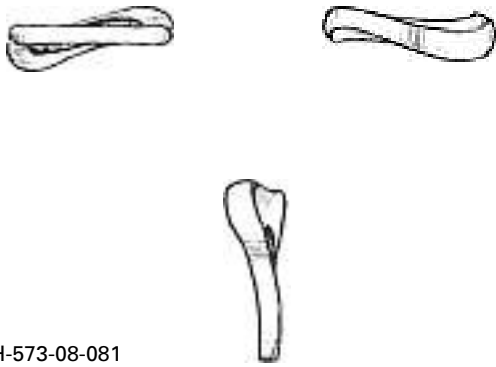

D-CH-573-08-081



D-CH-573-08-082





D-CH-573-08-09

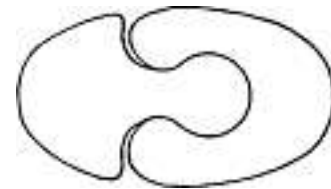
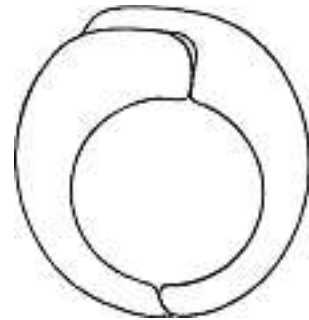
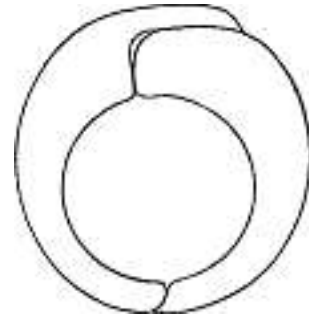
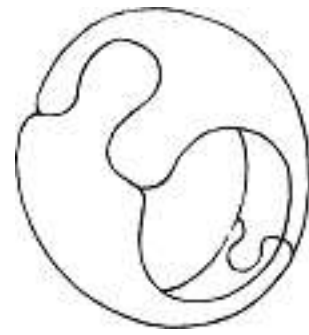

D-CH-573-08-10



D-CH-573-08-11





D-CH-573-08-12



D-CH-573-08-13





D-CH-573-08-14

Cl. 11-02 135 022 25.02.2008  
 2 Design – Dekorationsgegenstand, Ziergegenstand  
 Hinterleger: Urs Burkhalter, Bärenfelsenstrasse 12, Postfach,  
 4057 Basel

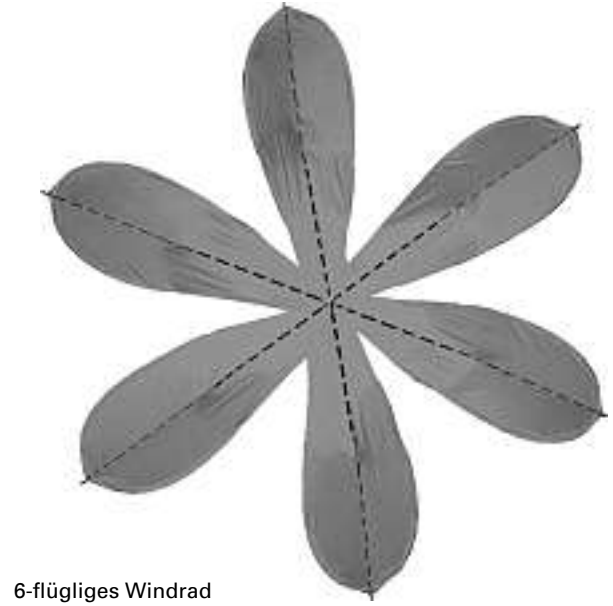
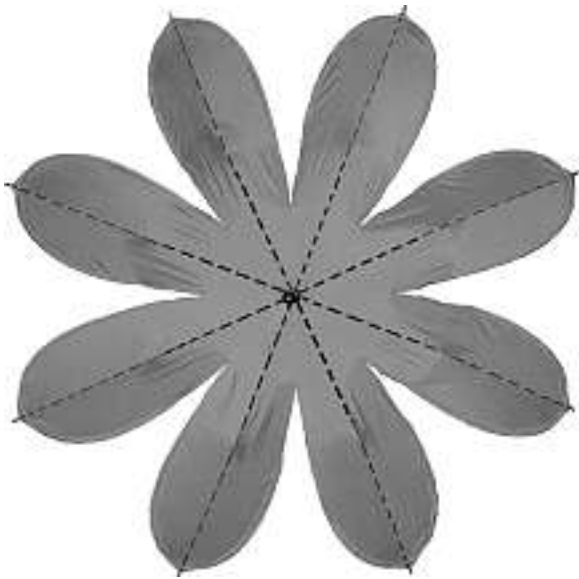

6-flügliges Windrad

Cl. 11-02 135 023 11.04.2008  
 1 Design – Pokal  
 Hinterleger: Fédération Internationale de Football Association  
 (FIFA), FIFA-Strasse 20, 8044 Zürich  
 Designer: Craig Cameron, Glasgow

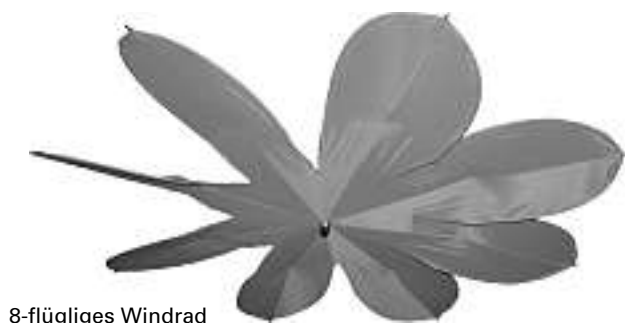

8-flügliges Windrad

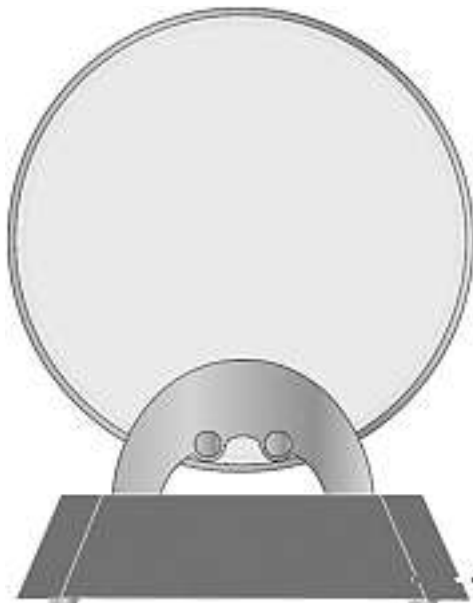

ID: 8/CH

Cl. 12-02 **135 024** 15.04.2008  
 1 Design – Schlauchwagen  
 Hinterleger: ALBA-KRAPF AG, Bleichweg 7a, Postfach 325,  
 9053 Teufen  
 Designer: Robert Krapf, Teufen

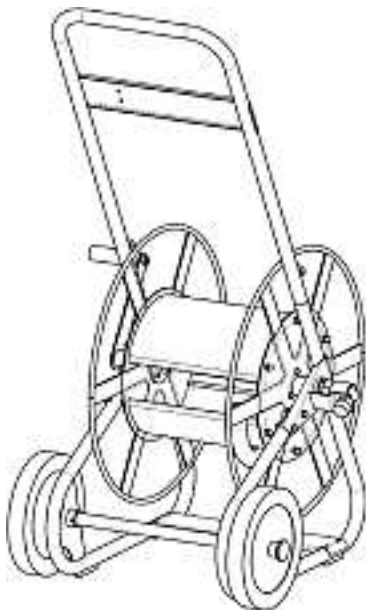

11450

Cl. 13-03 **135 025** 28.03.2008  
 1 Design – Steckverbinder  
 Hinterleger: Neutrik Aktiengesellschaft, Im alten Riet 143,  
 9494 Schaan, LI  
 Designer: Werner Bachmann, Schaan  
 Vertreter: PA Aldo Römpler, 9410 Heiden  
 Priorität: EM, 18.10.2007

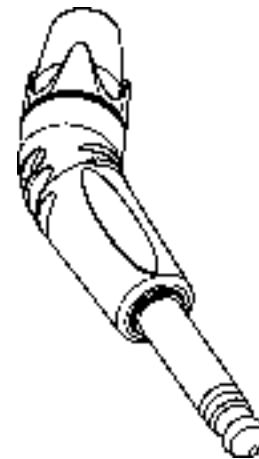
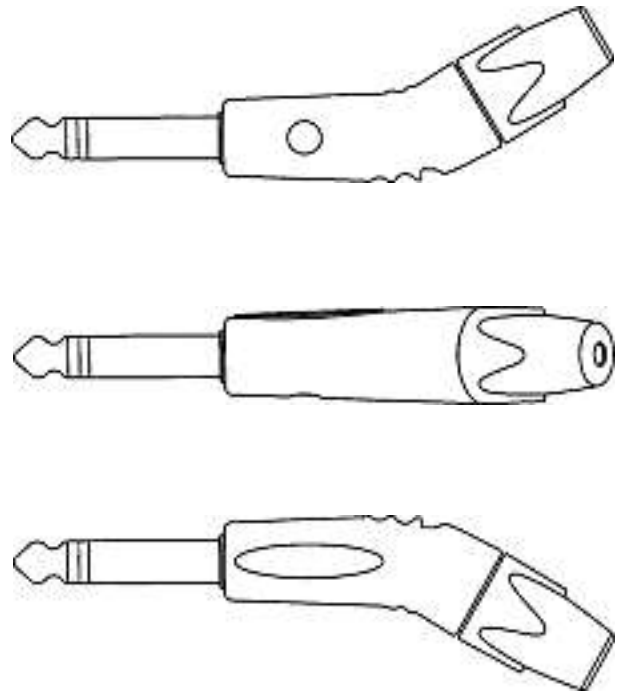

1

Cl. 13-03 **135 026** 08.04.2008  
 2 design – capteur de tension/courant électrique  
 Déposant: Liaisons Electroniques-Mécaniques LEM S.A., 8,  
 chemin des Aulx, 1228 Plan-les-Ouates  
 Designer: Pascal Morel, Saint Pierre en Faucigny  
 Mandataire: reuteler & cie SA, 1260 Nyon



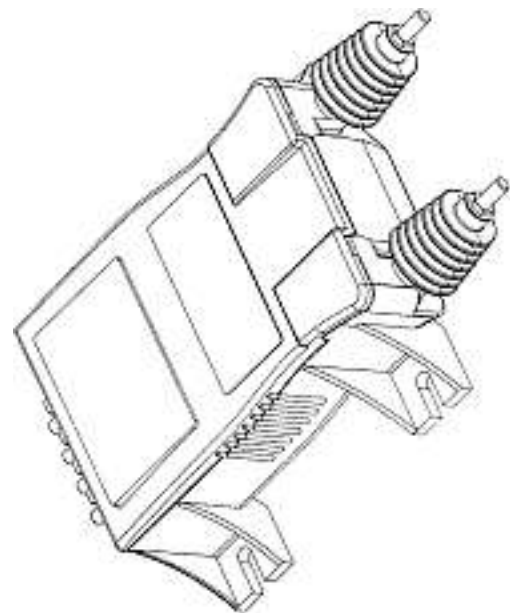
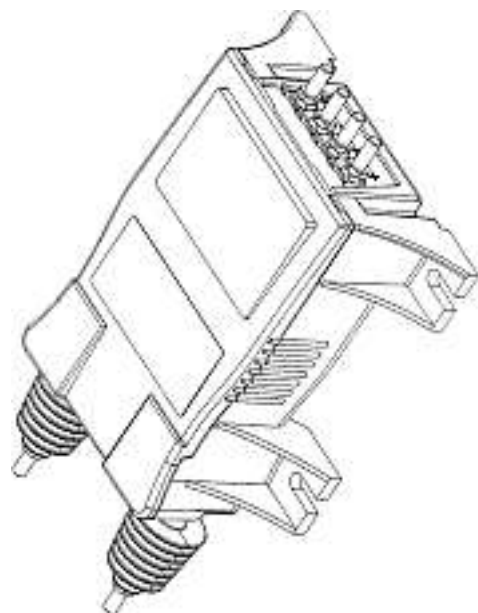
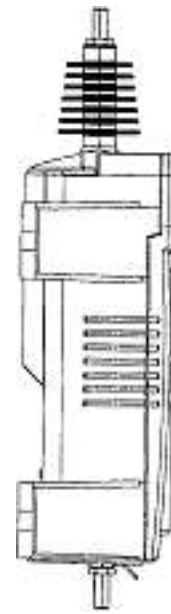
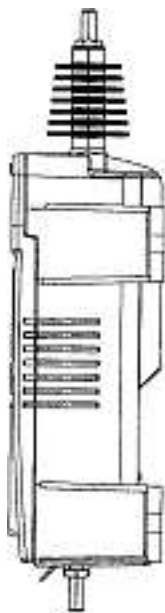
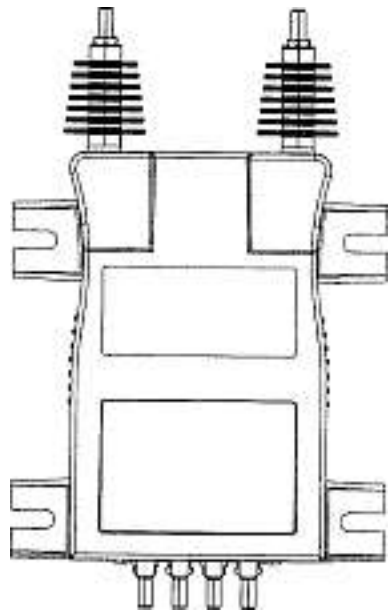
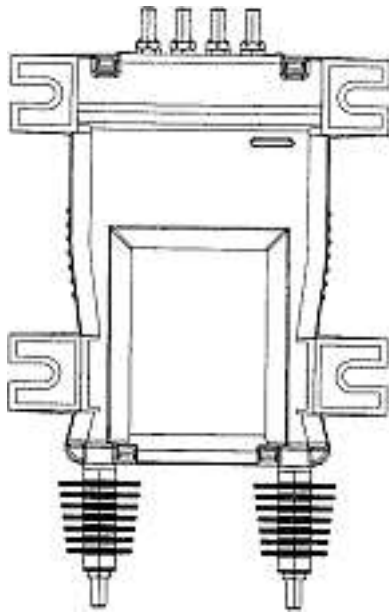

D1028CH00/1

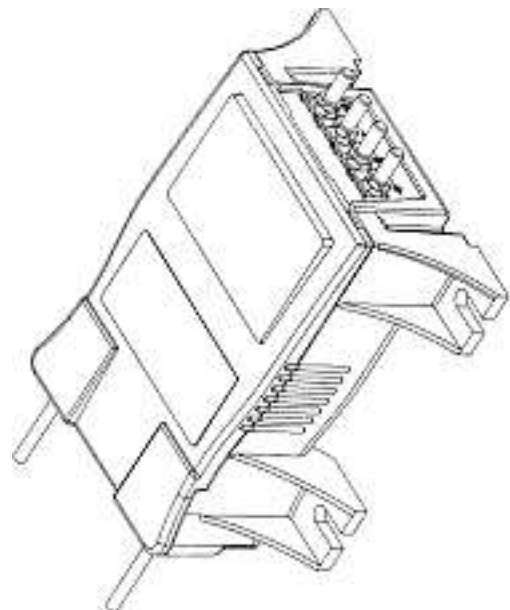
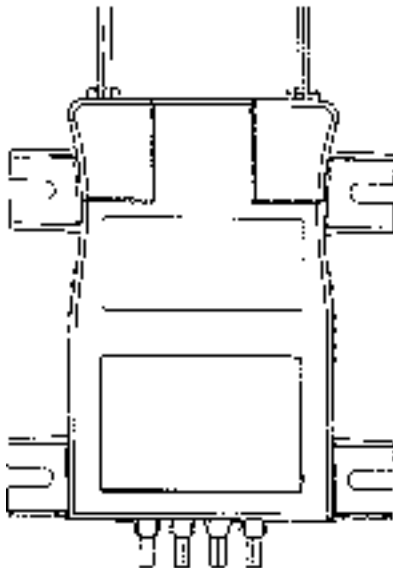
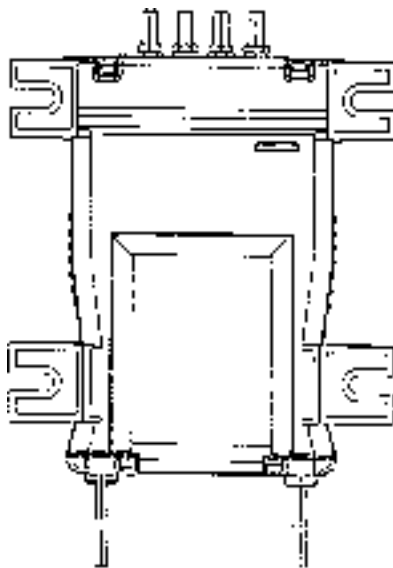
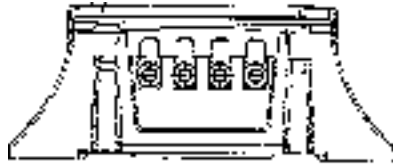
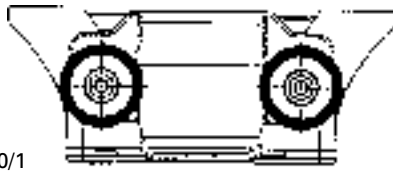

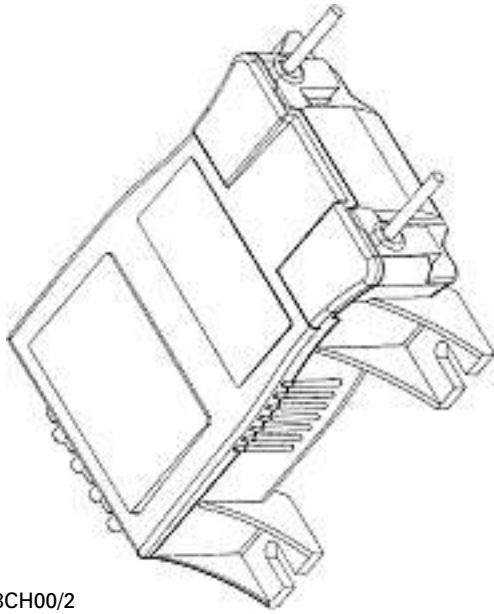

D1028CH00/2

Cl. 14-03 135 027 30.04.2008  
 1 design – support pour dispositif électronique  
 Déposant: Sony Computer Entertainment Inc., 2-6-21,  
 Minami-Aoyama, Minato-ku, Tokyo, JP  
 Designer: Naoto Shimizu, Tokyo  
 Mandataire: MICHELI & CIE SA, 1226 Thônex  
 Priorité: JP, 26.12.2007

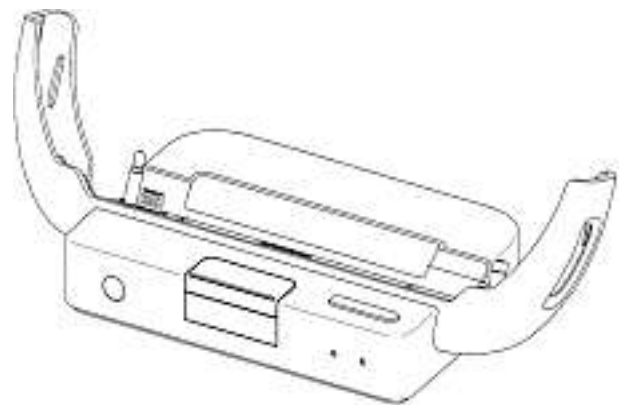
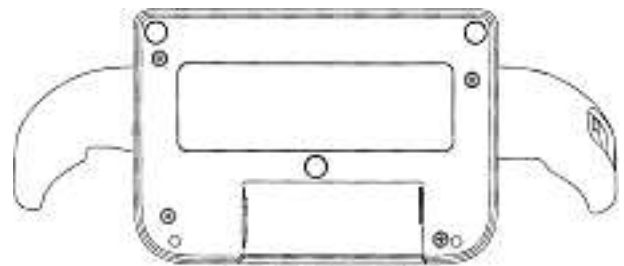
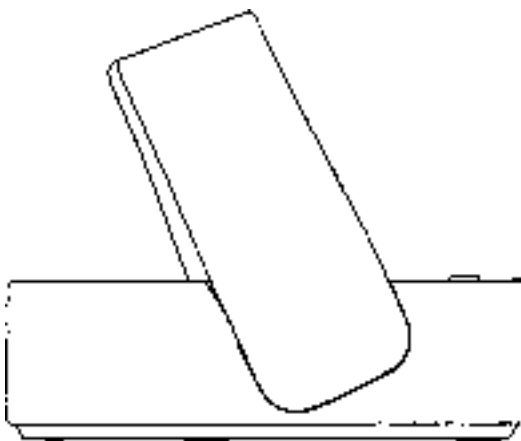
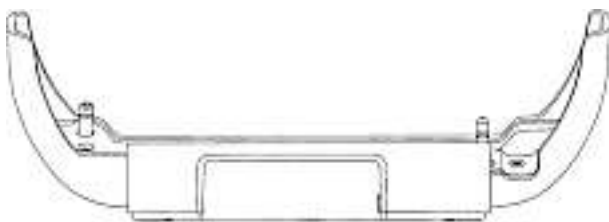
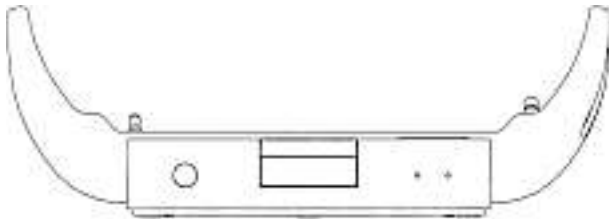
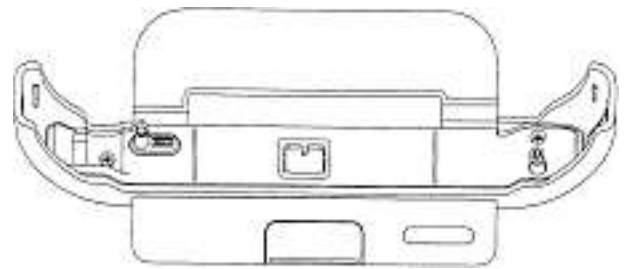
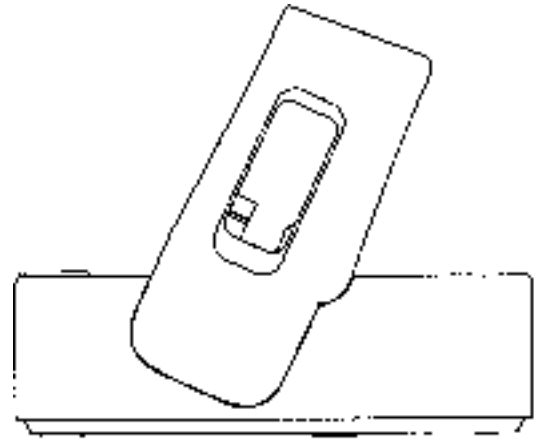

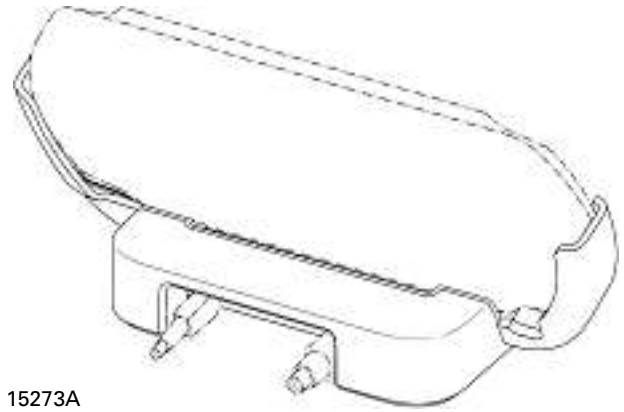
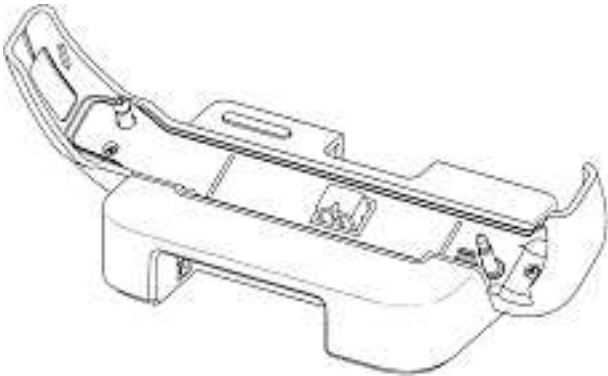
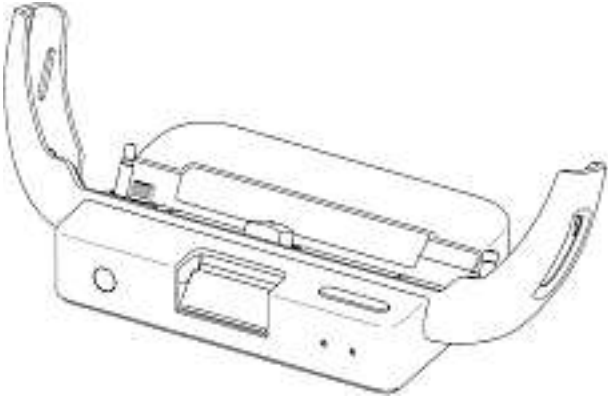

15273A

Cl. 15-05 **135 028** 28.03.2008  
 2 Design – Zubehör für Staubsauger  
 Hinterleger: AB ELECTROLUX, St. Göransgatan 143,  
 10545 Stockholm, SE  
 Designer: Esbjörn Svantesson, Täby; Greg Luebbering,  
 Heyworth  
 Vertreter: Troesch Scheidegger Werner AG, Patent- und  
 Markenanwälte, 8126 Zumikon  
 Priorität: EM, 14.01.2008

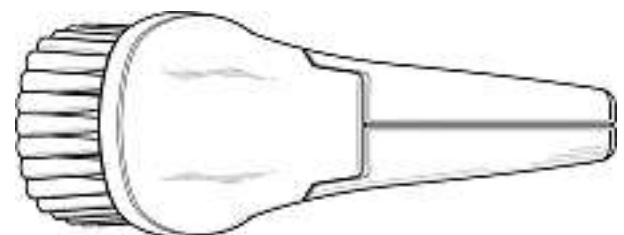
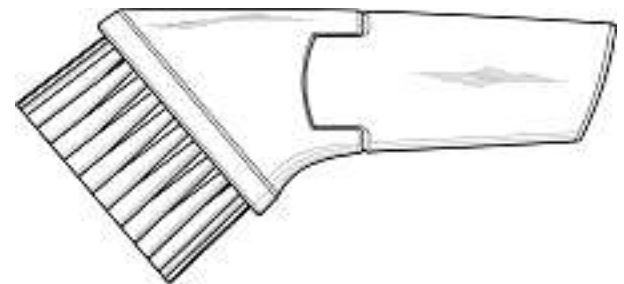
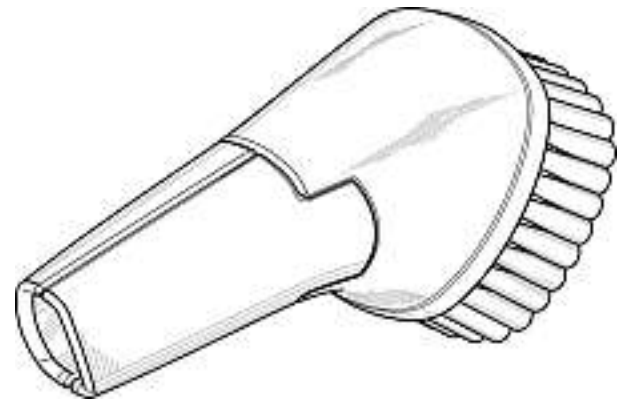

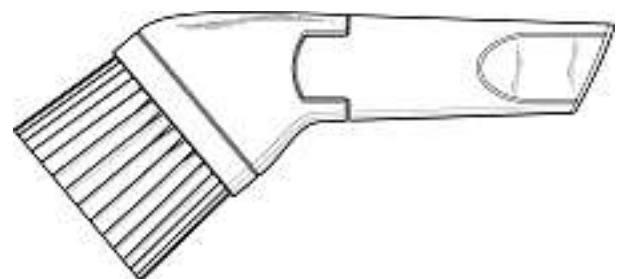
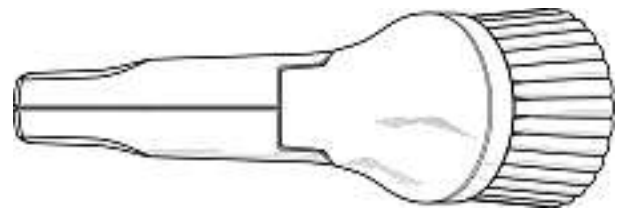
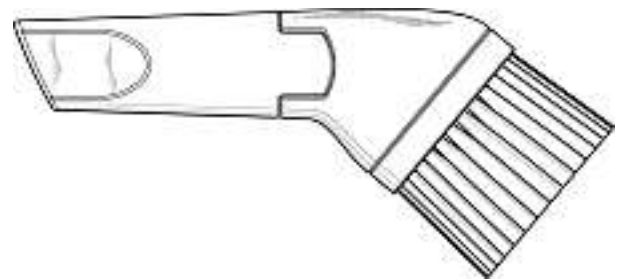
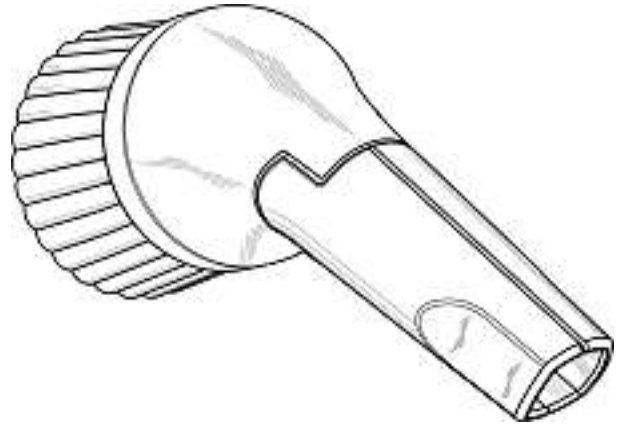
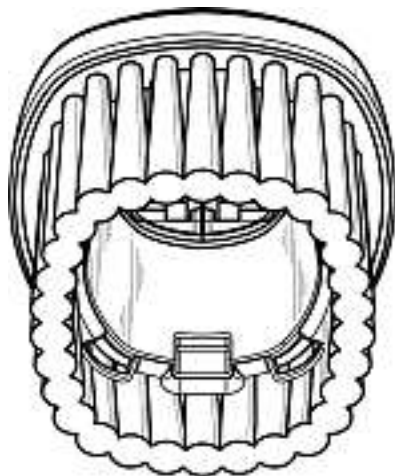
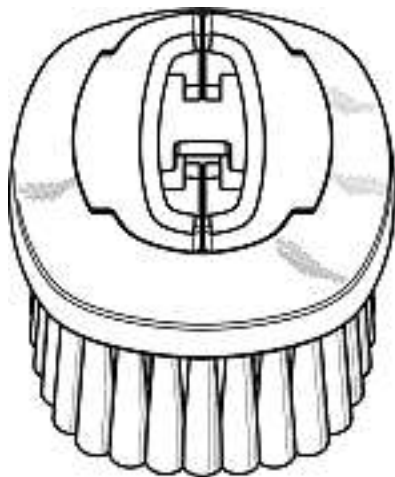
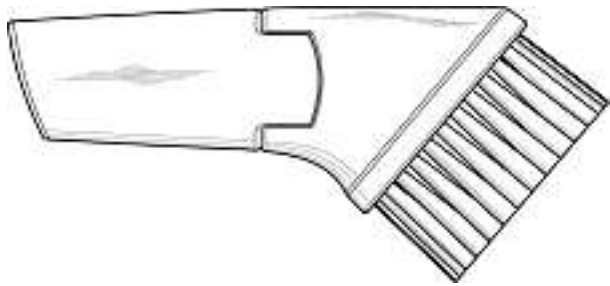
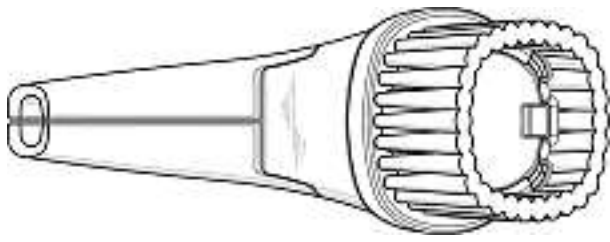



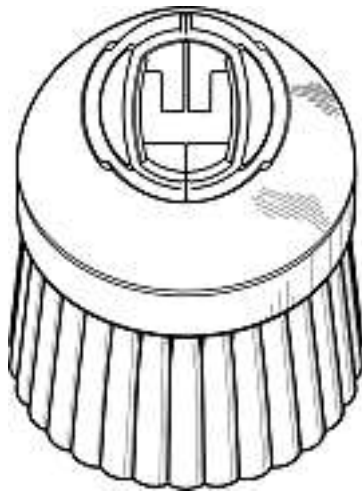

D300242-2

Cl. 17-03                      **135 029**                      27.03.2008  
 1 Design – Gitarre  
 Hinterleger: Triff AG, Delfterstrasse 41, 5004 Aarau  
 Designer: Mark Erismann, Aarau



1A

Cl. 19-02                      **135 030**                      03.04.2008  
 6 Design – Büroklammern  
 Hinterleger: Anton Schmid, Seehalde 22, 6243 Egolzwil



1

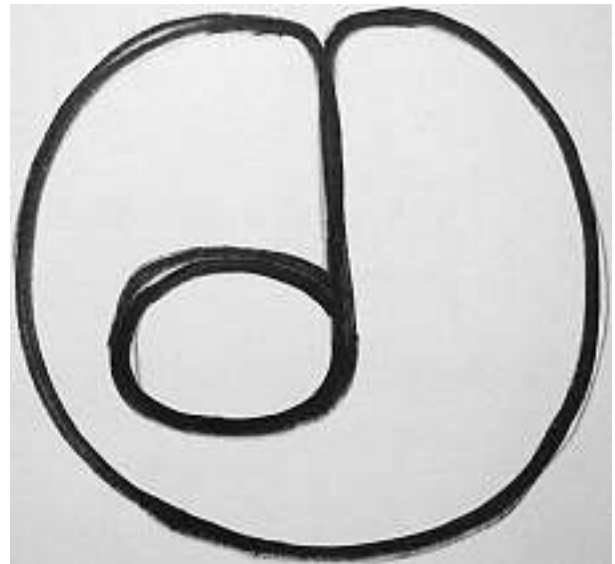

2

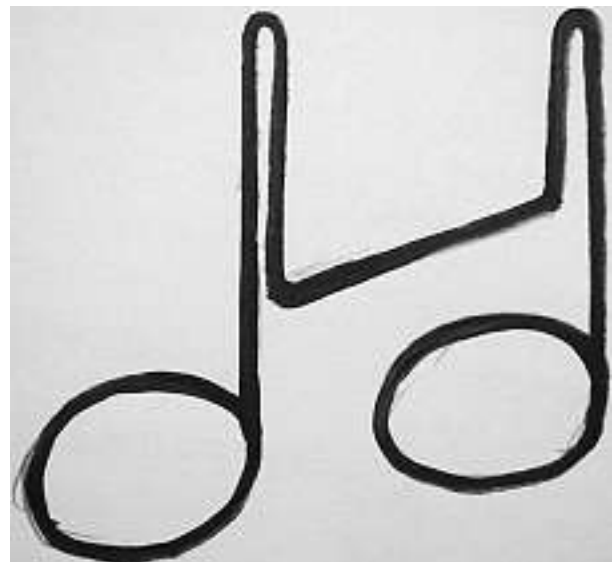

3

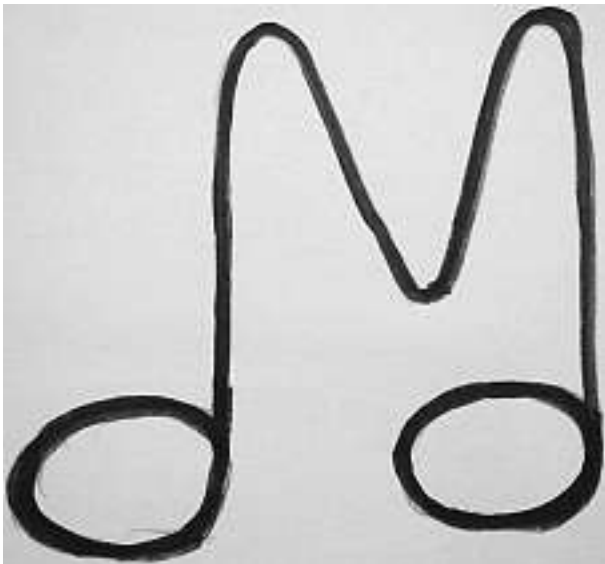

4

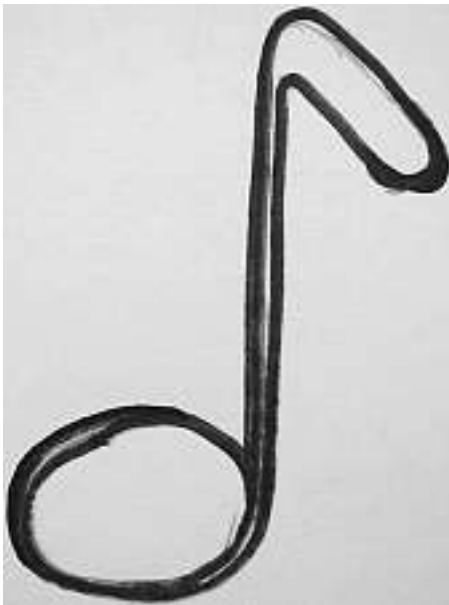

5



6

Cl. 19-04 135 031 30.11.2007  
3 Design – Informationsmappen  
Hinterleger: Ernst Schausberger & Co. GmbH, Heidestrasse 19,  
4623 Gunskirchen, AT  
Designer: Walter Demelbauer, Gunskirchen; Fritz Breuer,  
Sipbachzell  
Vertreter: KRSW WEINMANN, 8032 Zürich  
Priorität: EM, 04.10.2007; EM, 04.10.2007; EM, 04.10.2007

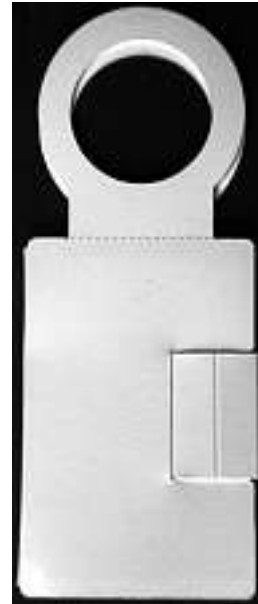

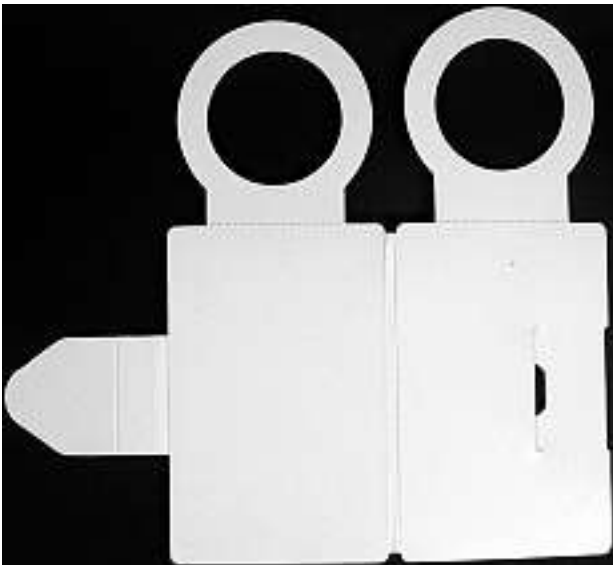
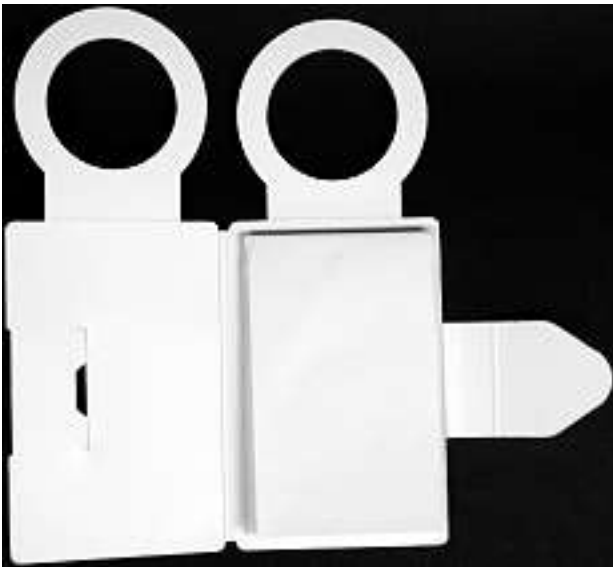

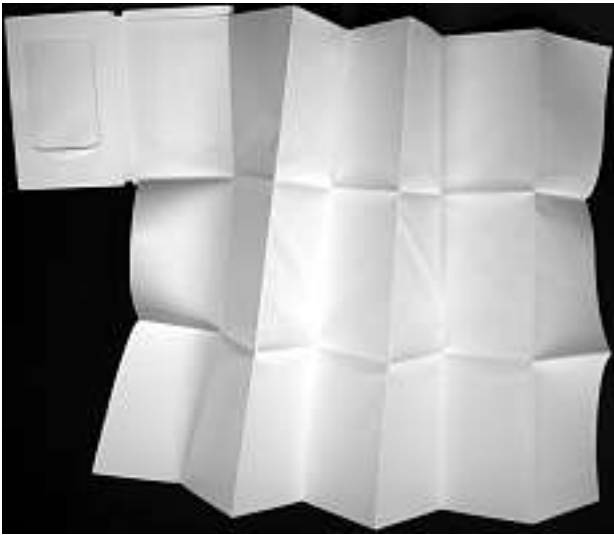
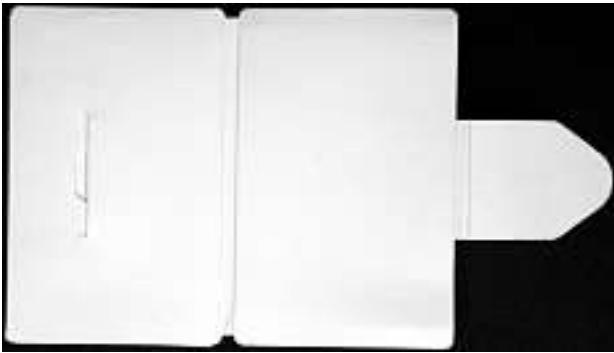

2



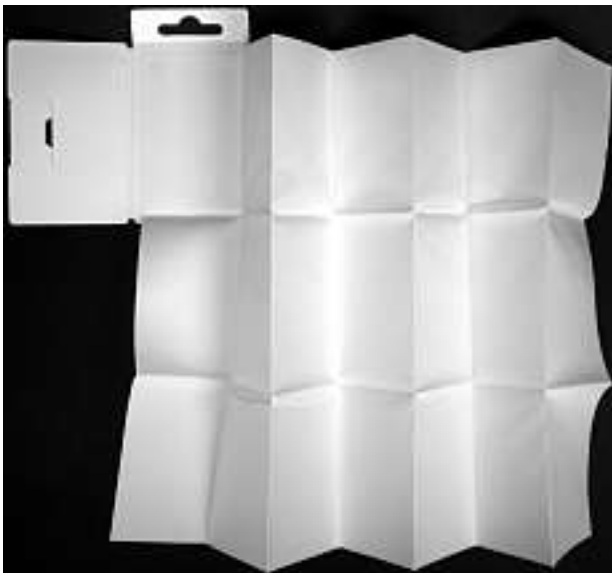

3

Cl. 19-06                      **135 032**                      31.03.2008  
 1 design – stylo  
 Déposant: Raymond Weil SA, 36-38, avenue Eugène-Lance,  
 1212 Grand-Lancy  
 Designer: Sébastien Actis-Datta, Villars-Tiercelin  
 Mandataire: Soprintel S.A., 2300 La Chaux-de-Fonds

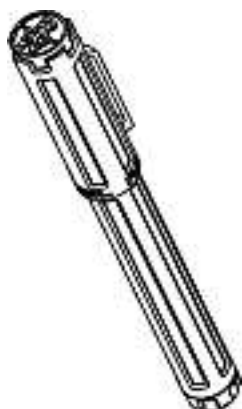

1

Cl. 20-02                      **135 033**                      01.04.2008  
 5 Design – Vorrichtungen für Warenpräsentation  
 Hinterleger: Karel Van De Velde, Route de Genève 62,  
 1180 Rolle  
 Vertreter: Zimmerli, Wagner & Partner AG, 8001 Zürich  
 Priorität: EM, 23.01.2008; EM, 23.01.2008; EM, 23.01.2008

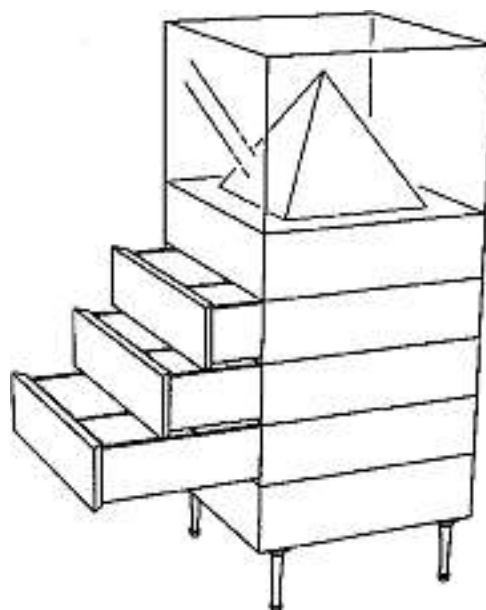
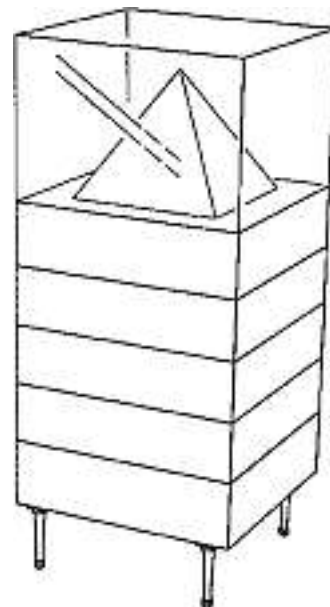

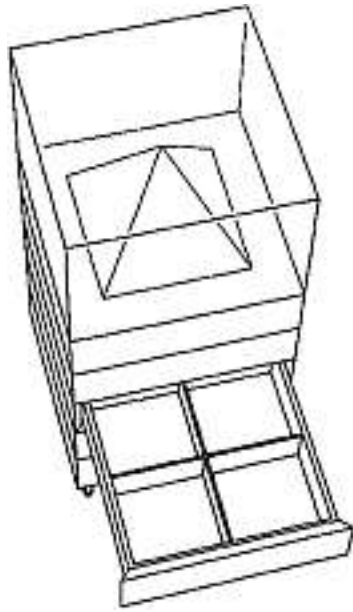

1

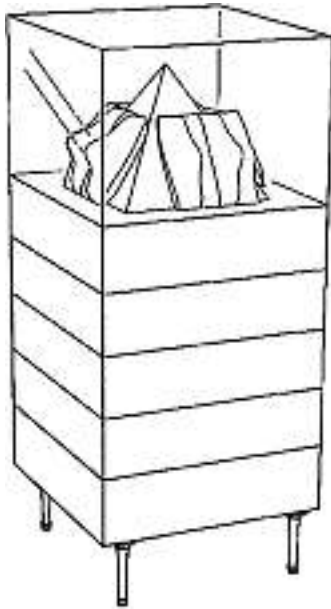
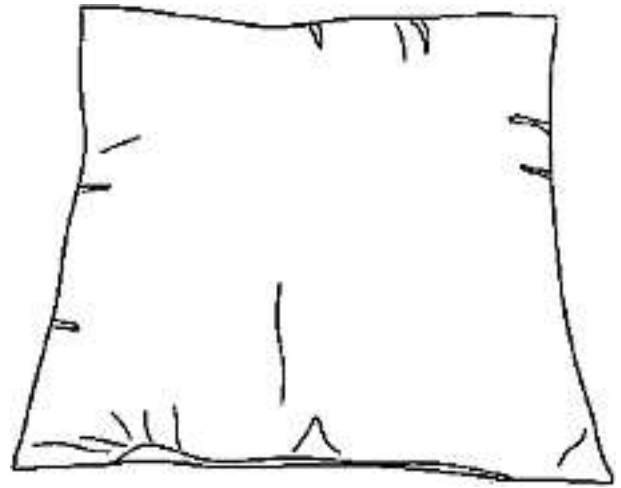

2

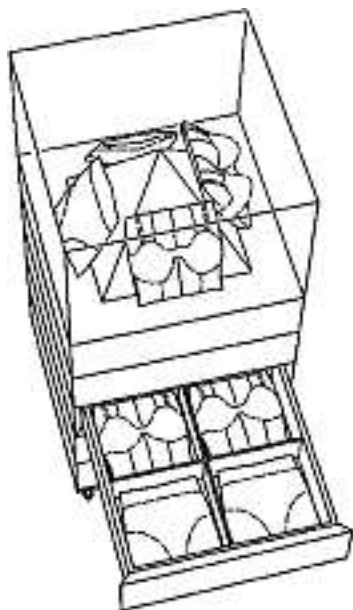
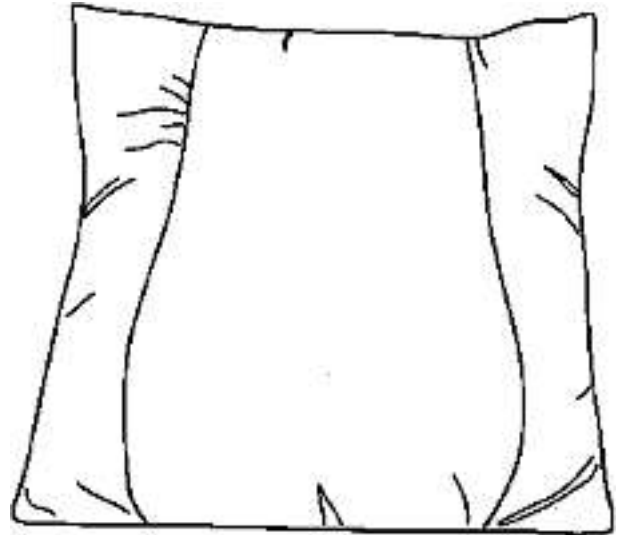

3

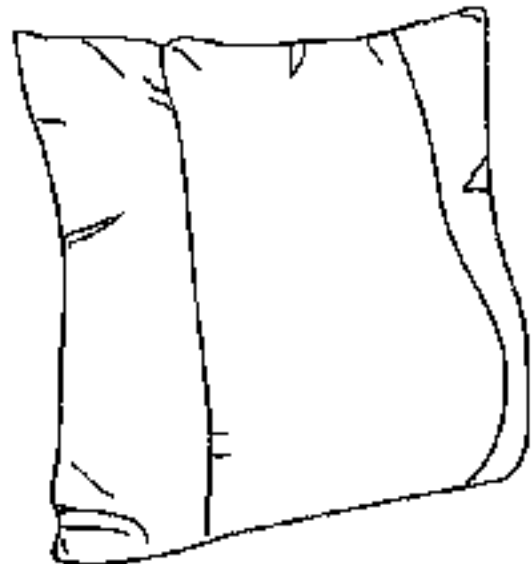

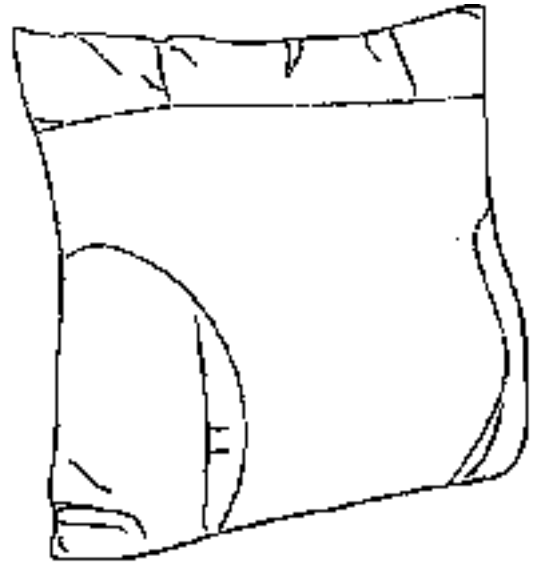
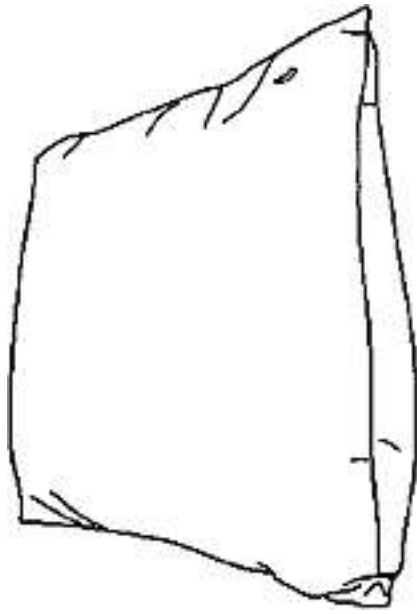

4

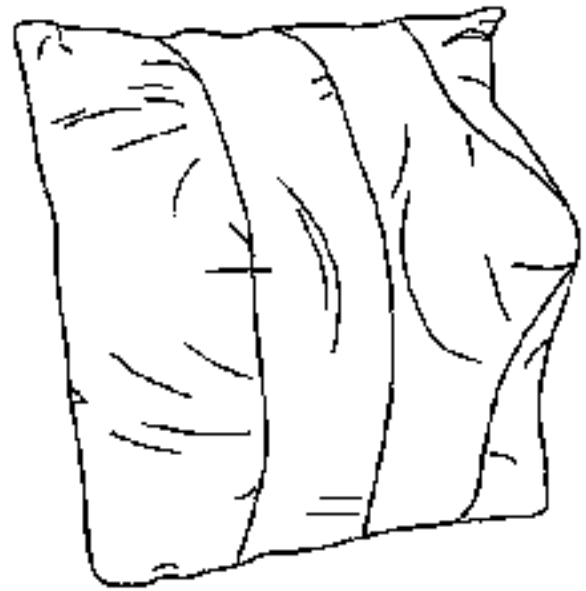
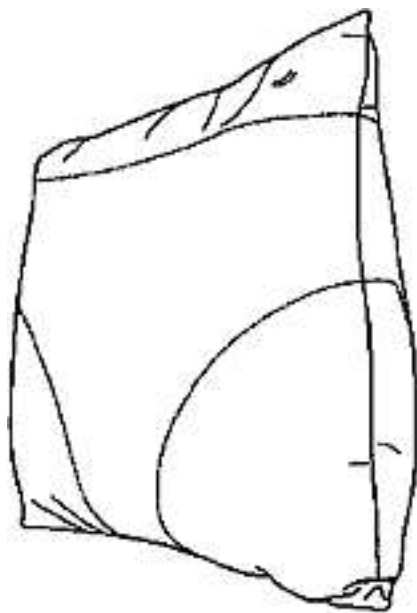
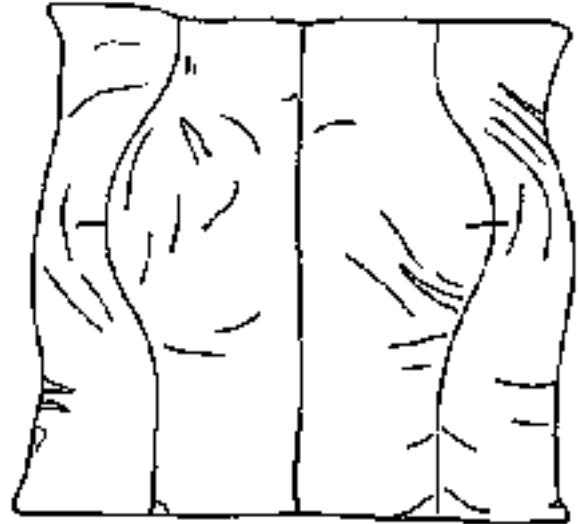
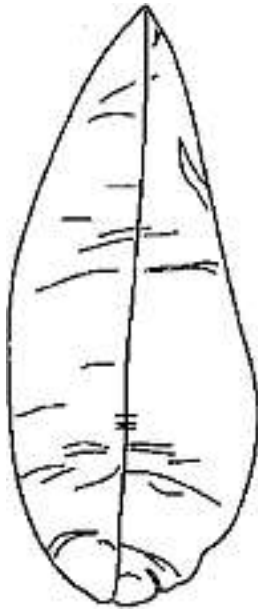

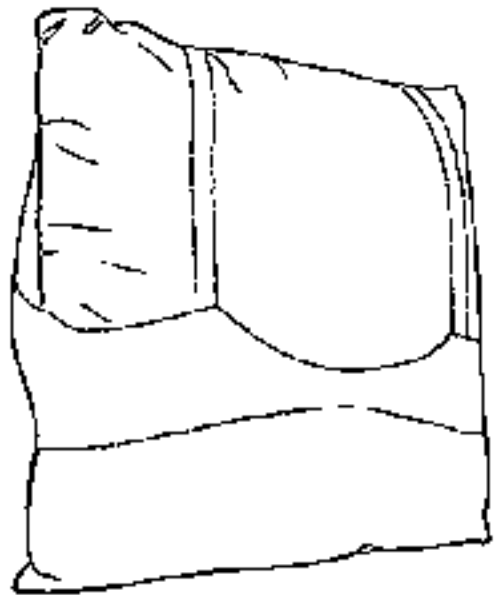
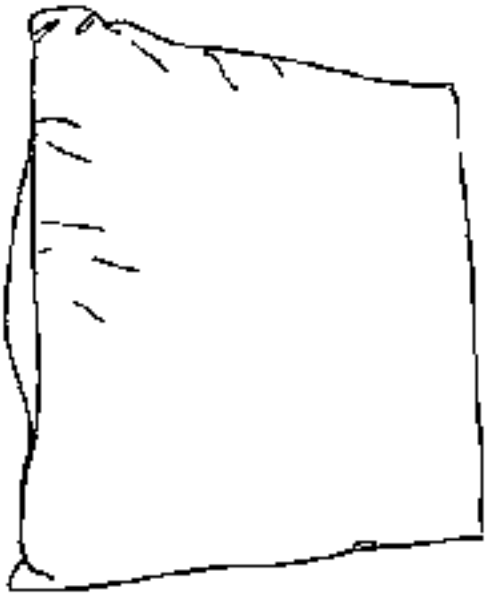
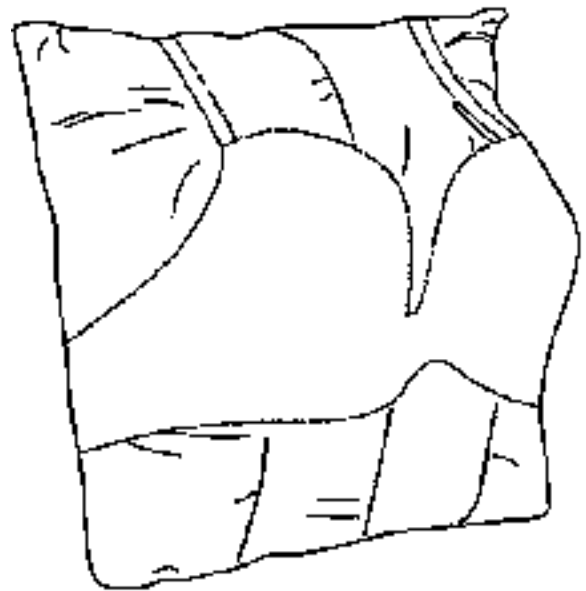
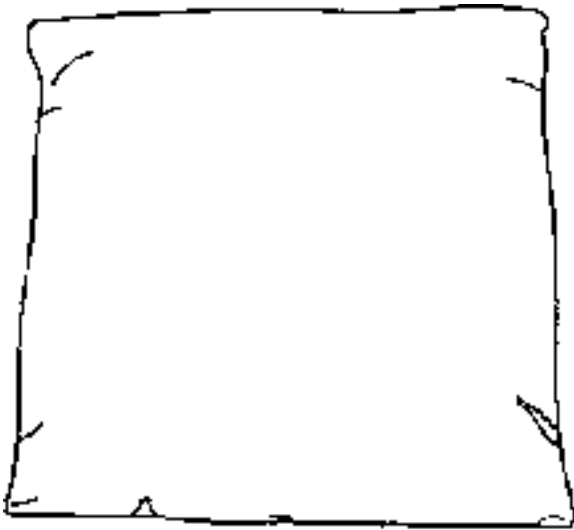

5

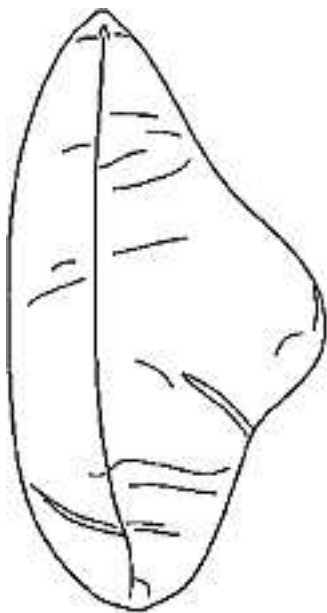

Cl. 20-03 135 034 24.03.2008  
19 Design – Terminal  
Hinterleger: A-Design AG, Baselstrasse 77, 4500 Solothurn  
Designer: Christa Angehrn Reichenbach, Solothurn





2



1



3





5

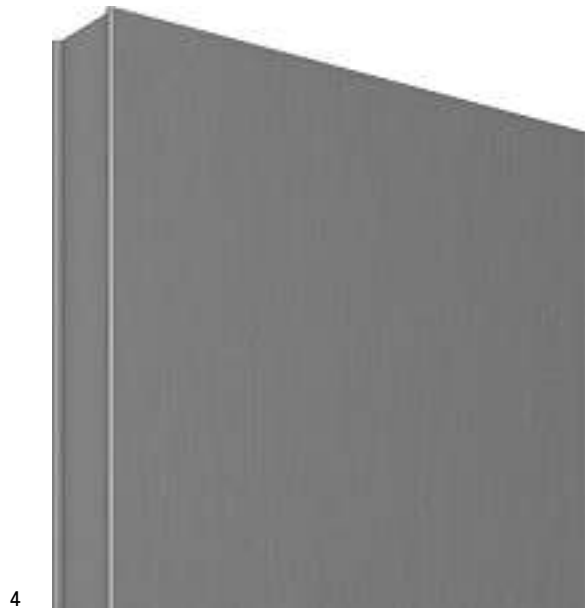
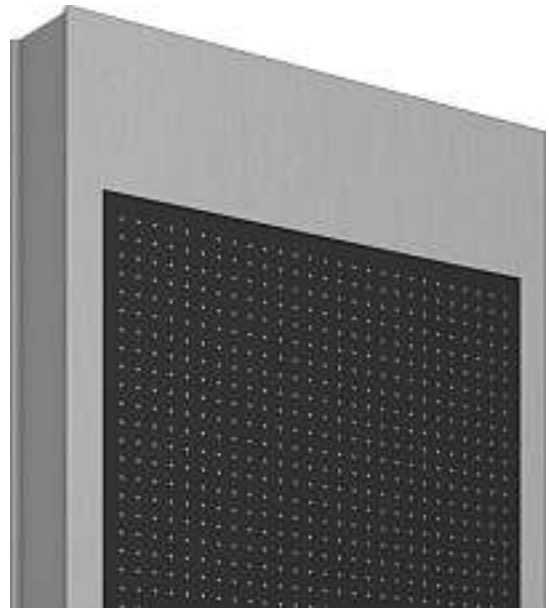

4



6





8



7



9



11



10



12





14



13



15



17



16



18

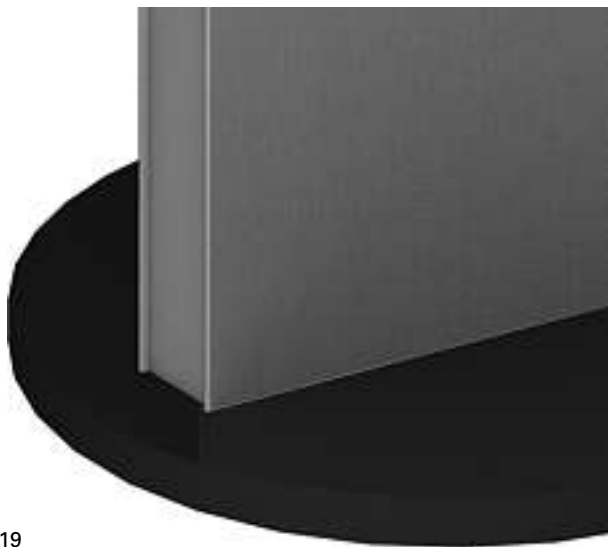

19

Cl. 21-01                      135 035                      04.04.2008  
 3 Design – Puppe  
 Hinterleger: Asta Blaskevičiute, Marktplatz 4,  
 91448 Emskirchen, DE  
 Vertreter: Peter Rutz, 6304 Zug  
 Priorität: EM, 10.10.2007



1



2



3



Cl. 23-03 135 037 01.04.2008  
7 Design – Kaminöfen  
Hinterleger: Hase Kaminofenbau GmbH,  
Niederkirchner Strasse 14, 54294 Trier, DE  
Designer: Walter Blasius, Trier; Fernando Najera, Trier  
Vertreter: Isler & Pedrazzini AG, 8027 Zürich  
Priorität: EM, 11.10.2007

M13486-1





M13486-2



M13486-3



M13486-4



M13486-5





M13486-6



M13486-7

Cl. 23-03                      **135 038**                      10.04.2008  
3 Design – Feuerstellen  
Hinterleger: Hans Greub AG, Lotzwil, Flurstrasse 40,  
4932 Lotzwil  
Designer: Hans Greub, Thunstetten

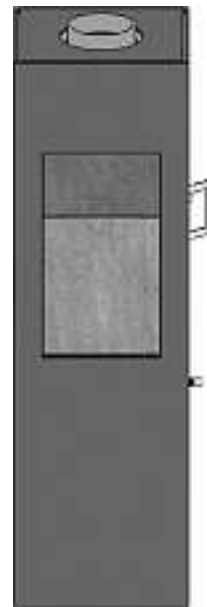
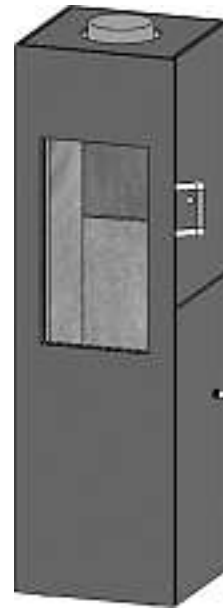
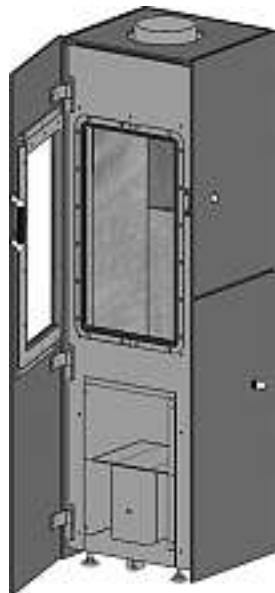

Toronto

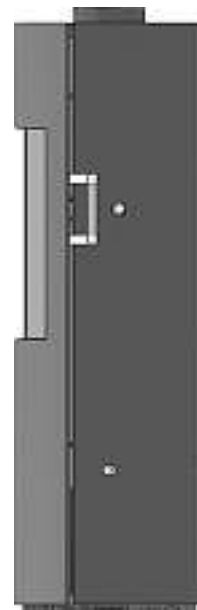
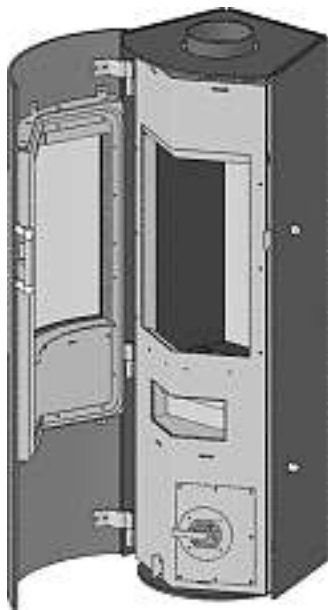

Giro

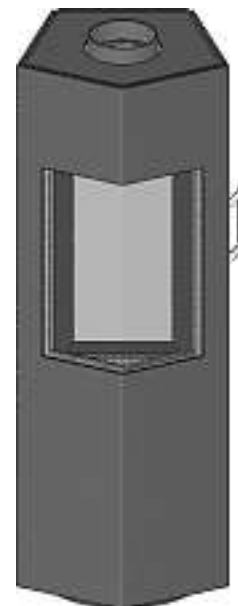
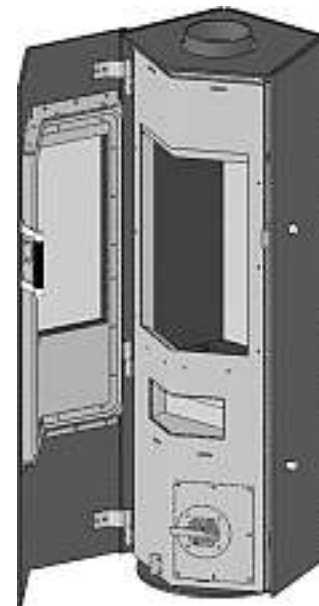

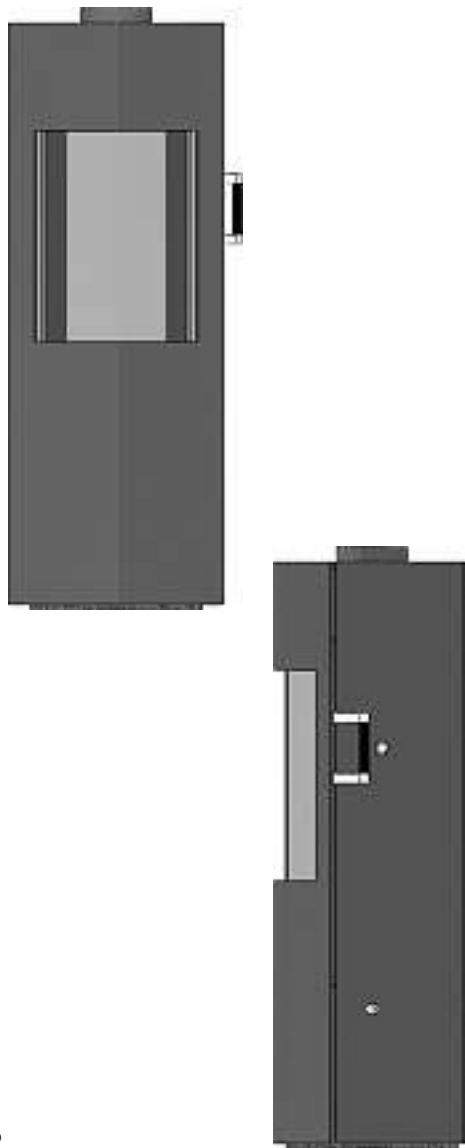

Quinto

Cl. 25-02 **135 039** 09.04.2008  
 3 Design – Bauteil/Wandelement  
 Hinterleger: Toggenburger Mondholzbau, Hans Gisler,  
 Neckertalstrasse 27, 9608 Ganterschwil  
 Designer: Hans Gisler, Wattwil  
 Vertreter: Schluop | Degen Rechtsanwälte, 3012 Bern

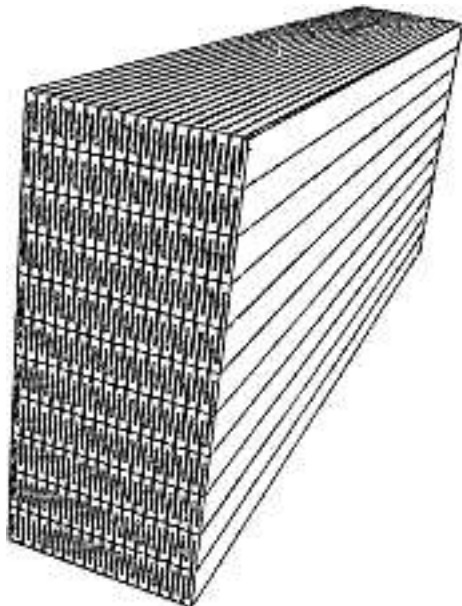

1

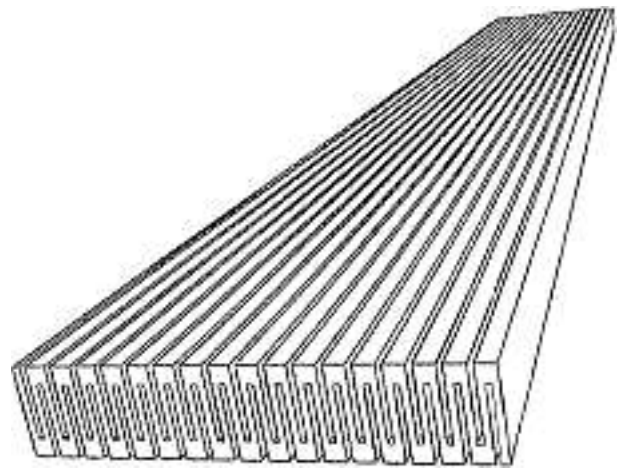

2

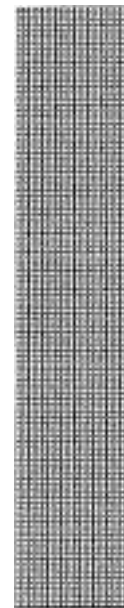

3

Cl. 26-05 **135 040** 01.04.2008  
 1 Design – Lampe  
 Hinterleger: Louis Poulsen Lighting A/S, Gammel Strand 28,  
 1202 Kopenhagen, DK  
 Designer: Norman Foster, London  
 Vertreter: Isler & Pedrazzini AG, 8027 Zürich  
 Priorität: EM, 19.03.2008

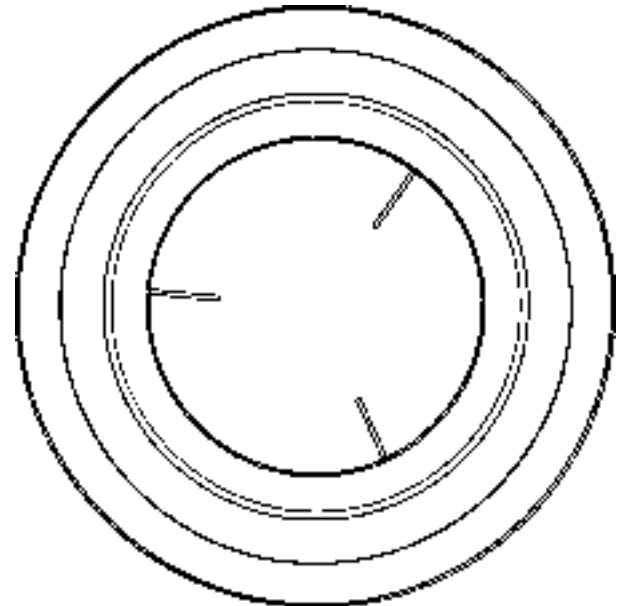

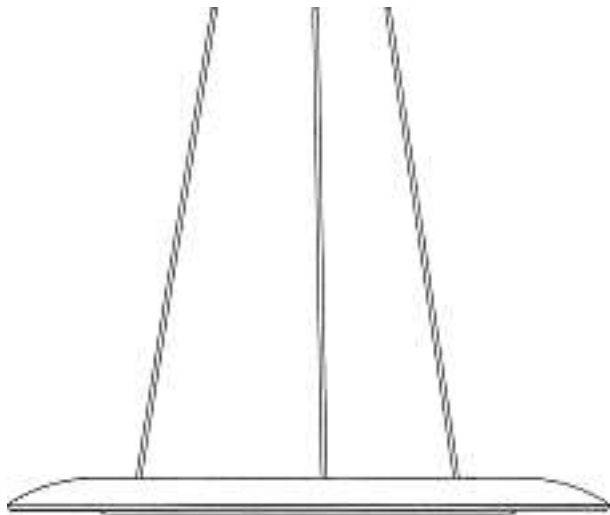
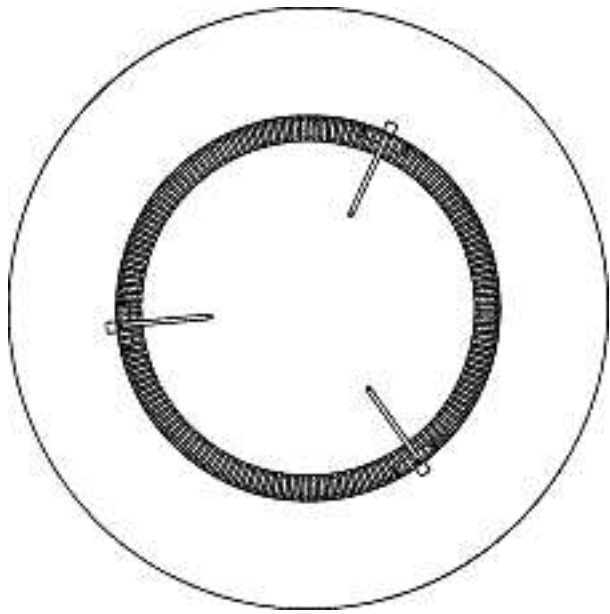

M13485

Cl. 26-05 135 041 03.04.2008  
5 Design - Lampen  
Hinterleger: Ansorg GmbH, Pilgerstrasse 11, 45473 Mülheim  
an der Ruhr, DE  
Designer: Otto Flach, Velbert; Jan Hilt, Rehlingen-Siersburg  
Vertreter: AXON Patent GmbH, 4147 Aesch

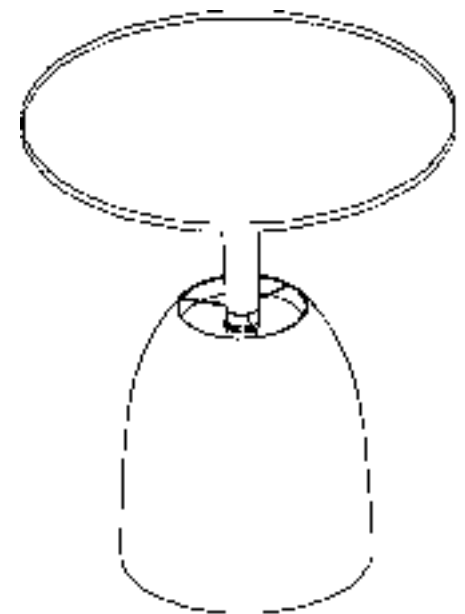
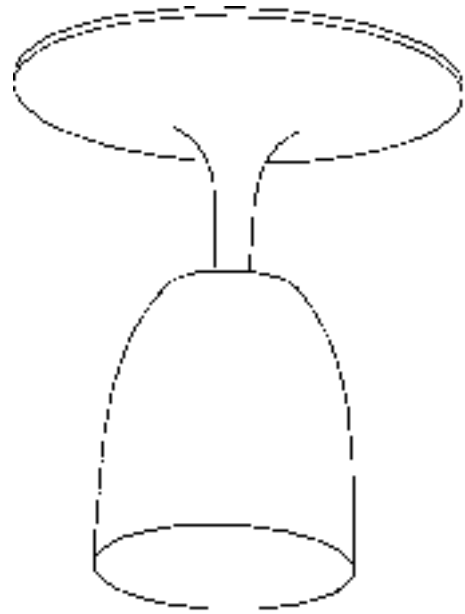

1

2



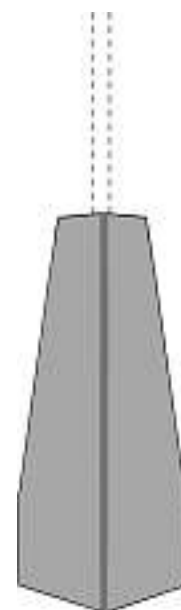

Cl. 26-05                      **135 042**                      03.04.2008  
2 Design – Lampen  
Hinterleger: Ansorg GmbH, Pilgerstrasse 11, 45473 Mülheim  
an der Ruhr, DE  
Designer: David Brühl, Darmstadt; Otto Flach, Velbert;  
Catharina Schuster, Darmstadt; Thorsten Wohner, Karlsruhe  
Vertreter: AXON Patent GmbH, 4147 Aesch

2

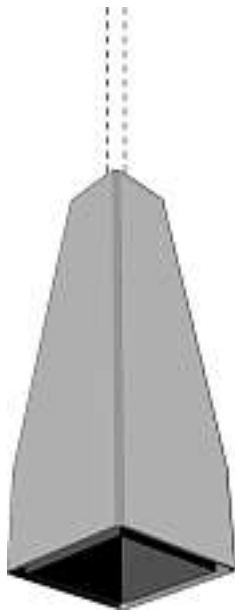

Cl. 26-05      **135 043**      03.04.2008  
4 Design – Lampen  
Hinterleger: Belux IP AG, Klünenfeldstrasse 22, 4132 Muttenz  
Designer: Naoto Fukasawa, Tokio  
Vertreter: AXON Patent GmbH, 4147 Aesch

2

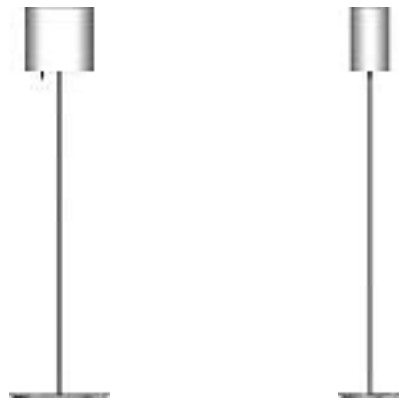

1

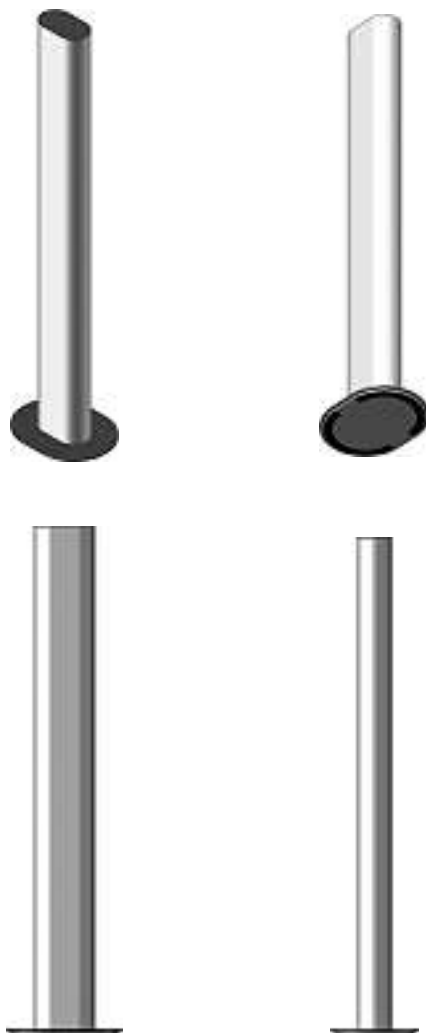



3



4

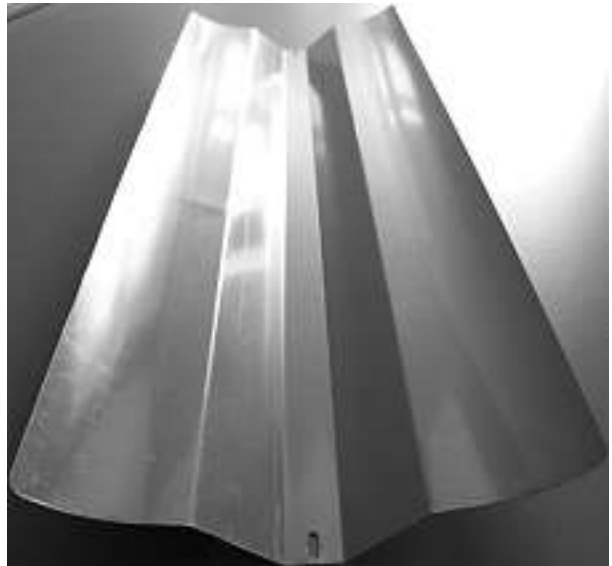
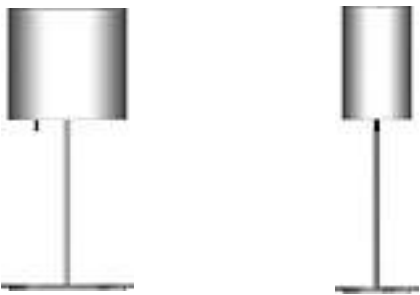

Cl. 26-05                      **135 044**                      09.04.2008  
 1 design – réflecteur du luminaire  
 Déposant: Pin-Siang Wang, 2F, No. 450, Sec. 2, JhongShan Rd., Jhonghe City, Taipei County 23557, TW  
 Mandataire: Jia Chen, 1219 Châtelaine



T5

Cl. 28-03                      **135 045**                      01.04.2008  
 2 Design – Massagegürtel/Massagegerät  
 Hinterleger: CCD Commercial Concept Development AG,  
 Freiestrasse 32, 3012 Bern  
 Designer: Peter Ziegler, Bettlach  
 Vertreter: Schlupe | Degen Rechtsanwälte, 3012 Bern



350085/1

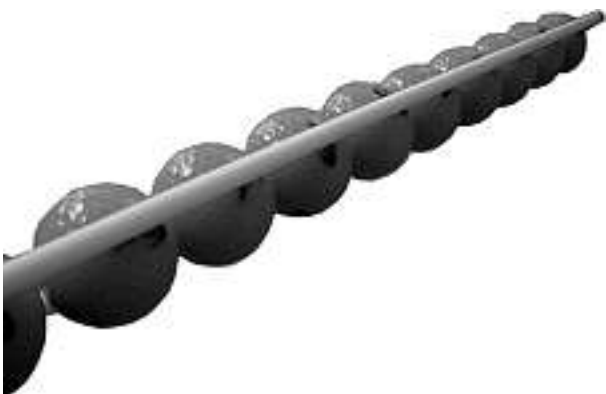

350085/2



yobushi

Cl. 99-00 135 046 11.04.2008  
1 Design - Urne  
Hinterleger: URNE.CH GmbH, Stationsstrasse 21, 8003 Zürich  
Designer: Thomas Schär, Zürich

**Verlängerungen  
Prolongations  
Prolongazioni**

116 704	Cl.	02-01	5 Design
116 822	Cl.	10-04	1 design
120 376	Cl.	25-01	5 Design



1



2



3



4

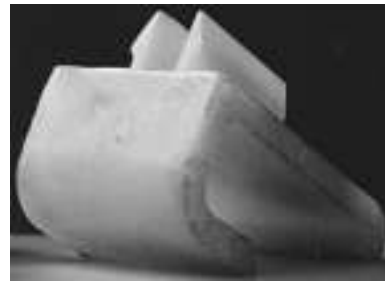

5

120 537	Cl.	06-01	1 Design
---------	-----	-------	----------

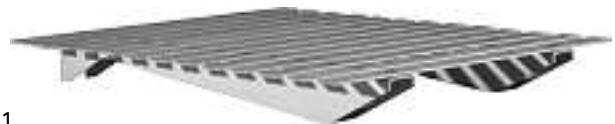

1

125 161	Cl.	14-02	1 Design
125 162	Cl.	14-02	8 Design
125 202	Cl.	14-02	1 Design
125 224	Cl.	09-01	1 design
125 255	Cl.	07-04	3 Design
125 274	Cl.	04-02	1 Design
125 317	Cl.	28-03	1 Design
125 318	Cl.	28-03	2 Design
125 593	Cl.	24-02	1 design
129 649	Cl.	06-03	6 Design
129 656	Cl.	08-09	1 Design
129 670	Cl.	21-02	1 design
129 695	Cl.	10-07	5 design
129 703	Cl.	13-99	1 Design
129 708	Cl.	21-01	1 Design
129 712	Cl.	25-01	4 design
129 717	Cl.	02-04	1 design
129 724	Cl.	06-01	4 design
129 725	Cl.	06-01	2 Design
129 734	Cl.	06-13	11 Design
129 763	Cl.	06-01	2 Design
129 799	Cl.	14-99	4 design
129 910	Cl.	06-06	1 Design
129 919	Cl.	07-03	3 Design
129 954	Cl.	25-02	1 Design
129 997	Cl.	14-01	1 Design
130 064	Cl.	26-05	1 Design
130 196	Cl.	25-02	1 Design

## Mutationen Modifications Modificazioni

116 143, 116 144, 116 178, 116 420, 116 455, 116 693, 116 757  
 117 050, 117 065, 117 472, 117 732, 117 765, 117 782, 117 816  
 117 841, 117 865, 118 248, 118 571, 118 604, 118 690, 118 829  
 118 949, 119 011, 119 231, 119 259, 119 442, 119 509, 119 685  
 119 764, 119 787, 119 863, 120 086, 120 099, 120 124, 120 159  
 120 202, 120 254, 120 337, 120 346, 120 531, 120 532, 120 542  
 120 569, 120 711, 120 740, 120 812, 120 826, 121 057, 121 061  
 121 083, 121 238, 121 383, 121 503, 121 504, 121 506, 121 521  
 121 562, 121 634, 121 683, 121 803, 121 843, 121 855, 122 019  
 122 046, 122 154, 122 210, 122 211, 122 212, 122 215, 122 223  
 122 227, 122 237, 122 281, 122 308, 122 333, 122 336, 122 340  
 122 421, 122 502, 122 579, 122 581, 122 582, 122 620, 122 695  
 122 842, 122 844, 122 845, 122 846, 122 847, 122 848, 122 849  
 123 805, 123 817, 124 003, 124 094, 124 165, 124 335, 124 349  
 124 410, 124 559, 124 560, 124 644, 124 698, 124 773, 124 787  
 124 822, 124 948, 124 969, 125 007, 125 008, 125 009, 125 049  
 125 050, 125 051, 125 052, 125 136, 125 137, 125 181, 125 190  
 125 274, 125 346, 125 380, 125 397, 125 403, 125 415, 125 490  
 125 500, 125 502, 125 512, 125 513, 125 514, 125 711, 125 712  
 125 713, 125 714, 125 716, 125 735, 125 736, 125 806, 125 847  
 125 848, 125 934, 126 003, 126 066, 126 101, 126 173, 126 206  
 126 227, 126 273, 126 344, 126 381, 126 415, 126 435, 126 488  
 126 520, 126 537, 126 538, 126 555, 126 658, 126 783, 126 795  
 126 834, 126 962, 127 097, 127 130, 127 160, 127 349, 127 352  
 127 404, 127 436, 127 451, 127 500, 127 538, 127 541, 127 587  
 127 608, 127 629, 127 653, 127 659, 127 748, 127 819, 127 845  
 128 001, 128 010, 128 029, 128 032, 128 060, 128 070, 128 174  
 128 199, 128 206, 128 226, 128 282, 128 327, 128 352, 128 397  
 128 440, 128 478, 128 495, 128 498, 128 501, 128 567, 128 585  
 128 637, 128 652, 128 694, 128 765, 128 801, 128 831, 128 869  
 128 922, 128 923, 128 928, 128 930, 128 931, 129 059, 129 060  
 129 064, 129 072, 129 084, 129 090, 129 127, 129 144, 129 145  
 129 257, 129 259, 129 278, 129 283, 129 306, 129 340, 129 359  
 129 369, 129 375, 129 391, 129 393, 129 430, 129 451, 129 452  
 129 467, 129 489, 129 536, 129 587, 129 602, 129 704, 129 734  
 129 784, 129 865, 129 890, 129 924, 129 977, 129 998, 130 014  
 130 060, 130 061, 130 123, 130 125, 130 163, 130 175, 130 184  
 130 198, 130 199, 130 201, 130 213, 130 220, 130 234, 130 266  
 130 275, 130 316, 130 334, 130 349, 130 375, 130 449, 130 453  
 130 483, 130 486, 130 497, 130 498, 130 511, 130 541, 130 591  
 130 600, 130 757, 130 790, 130 791, 130 816, 130 889, 130 921  
 130 962, 131 026, 131 036, 131 295, 131 301, 131 324, 131 358  
 131 374, 131 383, 131 410, 131 432, 131 472, 131 486, 131 503  
 131 510, 131 540, 131 675, 131 676, 131 683, 131 768, 131 845  
 131 855, 131 956, 132 057, 132 061, 132 154, 132 201, 132 202  
 132 224, 132 248, 132 257, 132 268, 132 269, 132 270, 132 271  
 132 326, 132 354, 132 358, 132 478, 132 578, 132 595, 132 671  
 132 680, 132 686, 132 713, 132 750, 132 752, 132 763, 132 779  
 132 820, 132 821, 132 848, 132 912, 132 918, 132 999, 133 000  
 133 005, 133 039, 133 058

Vertreter Firmaänderung

Vertreter: E. Blum & Co. AG, Patent- und Markenanwälte  
 VSP, 8044 Zürich

### 116 704

Neuer Vertreter

Vertreter: R. A. Egli & Co., Patentanwälte, 8008 Zürich

### 124 796

### 129 681

### 129 690

### 130 753

### 132 947

### 133 002

### 134 210

Vertreter Firmaänderung

Vertreter: Meisser & Partners, 7250 Klosters

### 126 438

### 128 779

### 128 858

### 130 514

### 130 698

### 131 865

### 132 379

### 134 142

Namensänderung

Hinterleger: URNE.CH GmbH, Stationsstrasse 21, 8003 Zürich

### 128 369

Übertragung

Hinterleger: GE Healthcare Bio-Sciences AB, Björkgatan 30,  
 751 84 Uppsala, SE

Vertreter: Isler & Pedrazzini AG, 8027 Zürich

### 130 014

Namensänderung

Hinterleger: Terreal, Société par Actions Simplifiée,  
 13-17 rue Pagès, 92150 Suresnes, FR

### 131 484

Neuer Vertreter

Vertreter: Hans Rudolf Gachnang, Patentanwalt,  
 8501 Frauenfeld

### 134 724

### 134 725

Transmission

Déposant: Chitra Subramaniam-Duella, Chemin de la Dôle 1,  
 1196 Gland, ; Marc Aeschbacher, 3 Grand Rue, 1183 Bursins,  
 Mandataire: Chitra Subramaniam-Duella, 1196 Gland

**Löschungen**  
**Radiations**  
**Radiazioni**

116 279	Cl.	06-03	1 Design
116 287	Cl.	08-06	1 Design
120 020	Cl.	07-06	1 Design
120 044	Cl.	02-03	12 Design
120 082	Cl.	20-01	1 Design
120 143	Cl.	09-03	1 Design
124 562	Cl.	06-01	2 Design
124 579	Cl.	25-03	1 Design
124 594	Cl.	08-03	1 Design
124 604	Cl.	11-01	7 design
124 631	Cl.	06-01	3 Design
124 673	Cl.	07-03	1 Design
124 680	Cl.	10-02	1 design
129 091	Cl.	04-02	1 Design
129 117	Cl.	23-03	1 design
129 124	Cl.	30-03	1 Design
129 138	Cl.	08-03	1 Design
129 141	Cl.	09-03	3 Design
129 161	Cl.	19-08	1 Design
129 172	Cl.	11-01	6 design
129 215	Cl.	03-01	5 design
129 233	Cl.	11-01	10 design
129 234	Cl.	11-01	6 design
129 249	Cl.	02-01	5 Design
129 250	Cl.	03-01	1 Design
129 254	Cl.	06-07	1 Design
129 255	Cl.	07-06	1 Design
129 258	Cl.	08-09	1 Design
129 274	Cl.	23-03	2 design
129 280	Cl.	07-06	1 Design
129 286	Cl.	10-02	1 design
129 290	Cl.	11-01	2 Design
129 291	Cl.	11-02	1 Design
129 293	Cl.	11-02	1 design
129 296	Cl.	19-08	8 Design
129 302	Cl.	26-05	1 design